

**IN THE UNITED STATES DISTRICT COURT
FOR THE EASTERN DISTRICT OF TEXAS
SHERMAN DIVISION**

AMERICAN PATENTS LLC,

Plaintiff,

v.

MEDIATEK INC. AND MEDIATEK USA
INC.,

Defendants.

CIVIL ACTION NO. 4:22-cv-478

ORIGINAL COMPLAINT FOR
PATENT INFRINGEMENT

JURY TRIAL DEMANDED

ORIGINAL COMPLAINT FOR PATENT INFRINGEMENT

Plaintiff American Patents LLC (“American Patents” or “Plaintiff”) files this original complaint against Defendants MediaTek Inc. and MediaTek USA Inc. (collectively “MediaTek” or “Defendants”), alleging, based on its own knowledge as to itself and its own actions and based on information and belief as to all other matters, as follows:

PARTIES

1. American Patents is a limited liability company formed under the laws of the State of Texas, with its principal place of business at 2325 Oak Alley, Tyler, Texas, 75703.
2. MediaTek Inc. is a company incorporated under the laws of Taiwan, having an address of No. 1, Dusing Road 1, Hsinchu Science Park, Hsinchu City 30078, Taiwan. MediaTek Inc. may also be served with process by serving the Texas Secretary of State, 1019 Brazos Street, Austin, Texas, 78701, as its agent for service because it engages in business in Texas but has not designated or maintained a resident agent for service of process in Texas as required by statute. This action arises out of that business.

3. MediaTek USA Inc. is a company duly organized and existing under the laws of Delaware. MediaTek USA Inc. may be served through its registered agent C T Corporation System at 1999 Bryan Street Suite 900, Dallas, Texas 75201.

4. MediaTek USA Inc. is an indirect subsidiary of MediaTek Inc. MediaTek USA Inc. is involved in the research and manufacture of semiconductor products, including wireless communications products.

5. The Defendants identified in paragraphs 2-3 above (collectively, “MediaTek”) are companies which together comprise the world’s 4th largest global fabless semiconductor company, powering more than 1.5 billion devices a year. MediaTek products can be found in 20 percent of homes globally, and nearly one of every three mobile phones is powered by MediaTek.¹

6. The MediaTek defendants named above and their affiliates are part of the same corporate structure and distribution chain for the making, importing, offering to sell, selling, and/or using of the accused devices in the United States, including in the State of Texas generally and this judicial district in particular.

7. The MediaTek defendants named above and their affiliates share the same management, common ownership, advertising platforms, facilities, distribution chains and platforms, and accused product lines and products involving related technologies. According to MediaTek, the “[b]usiness scope of MediaTek and its affiliates include the investment, R&D, promotion, after-sale service for optical storage products, digital consumer products, wireless

¹ See <https://i.MediaTek.com/about-MediaTek>

communication, digital TV, networking, analog, etc.,” and “MediaTek affiliates support the Company’s core business by acquiring leading technology through investments.”²

8. The MediaTek defendants named above and their affiliates regularly contract with customers regarding products made for or on behalf of those customers.

9. Thus, The MediaTek defendants named above and their affiliates operate as a unitary business venture and are jointly and severally liable for the acts of patent infringement alleged herein.

JURISDICTION AND VENUE

10. This is an action for infringement of United States patents arising under 35 U.S.C. §§ 271, 281, and 284–85, among others. This Court has subject matter jurisdiction of the action under 28 U.S.C. § 1331 and § 1338(a).

11. This Court has personal jurisdiction over MediaTek pursuant to due process and/or the Texas Long Arm Statute because, *inter alia*, (i) MediaTek has done and continues to do business in Texas; (ii) MediaTek has committed and continues to commit acts of patent infringement in the State of Texas, including making, using, offering to sell, and/or selling accused products in Texas, and/or importing accused products into Texas, including by Internet sales and sales via retail and wholesale stores, inducing others to commit acts of patent infringement in Texas, and/or committing a least a portion of any other infringements alleged herein; and (iii) MediaTek USA Inc. is registered to do business in Texas. In the alternative, Defendant MediaTek Inc. is subject to this Court’s specific personal jurisdiction consistent with the principles of due process and the Federal Long-Arm Statute of Fed. R. Civ. P. 4(k)(2)

² See MediaTek Annual Report (2019) at 94, <https://cdn-www.mediatek.com/posts/2019-MediaTek-Annual-Report.pdf>. See also <https://www.mediatek.com/corporate-social-responsibility/global-presence/global-operations>.

because: (1) it has substantial contacts with the United States and committed and/or induced acts of patent infringement in the United States; and (2) it is not subject to jurisdiction in any state's courts of general jurisdiction.

12. Venue is proper as to Defendant MediaTek Inc., which is organized under the laws of Taiwan. 28 U.S.C. § 1391(c)(3) provides that “a defendant not resident in the United States may be sued in any judicial district, and the joinder of such a defendant shall be disregarded in determining where the action may be brought with respect to other defendants.”

13. Venue is proper in this district as to MediaTek USA Inc. pursuant to 28 U.S.C. § 1400(b). Venue is further proper because MediaTek USA Inc. has committed and continues to commit acts of patent infringement in this district, including making, using, offering to sell, and/or selling accused products in this district, and/or importing accused products into this district, including by Internet sales and sales via retail and wholesale stores, inducing others to commit acts of patent infringement in Texas, and/or committing at least a portion of any other infringements alleged herein in this district. MediaTek USA Inc. has regular and established places of business in this district, including at least at 825 Watters Creek Blvd, Suite 625, Allen, Texas 75103, as shown in the following screenshots:

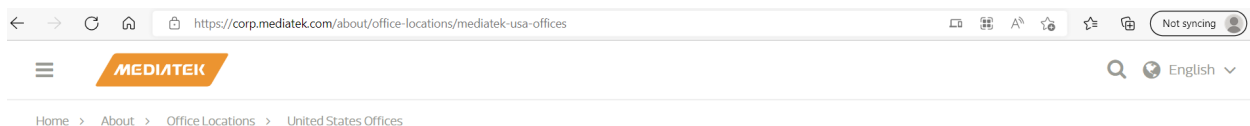

United States Office Locations

MediaTek USA Inc. (Dallas)
 825 Watters Creek Blvd, Suite 265
 Allen, TX 75103
 United States
[View Map](#)

(Source: <https://corp.mediatek.com/about/office-locations/mediatek-usa-offices>)

The screenshot shows the Collin Central Appraisal District website. The header includes a logo and navigation links: Home, Property Search, Maps, Downloads, Forms, and Reports. The main content area is titled "Property Search" and features buttons for "New Search", "Revise Current Search", and "Export Results". A legend on the right side identifies property types: Business Personal Property (pink), Mineral (blue), Mobile Home (orange), and Real (green). Below the legend, it states "Matching properties 1 property" and "Displaying all 1 results". A table lists the following property:

Property ID <small>Geographic ID</small>	Owner Name	Property Address	Legal Description	2022 Market Value
1 2837974 <small>P-9000-222-1569-1</small>	MEDIATEK USA INC	825 Watters Creek Blvd #00265 Allen, TX 75013	BPP at 825 Watters Creek Blvd	Currently Unavailable

(Source: Screenshot from Collin CAD website)

BACKGROUND

14. The patents-in-suit generally pertain to communications networks and other technology used in “smart” devices such as smartphones, smart TVs, and smart appliances. The technology disclosed by the patents was developed by personnel at Georgia Institute of Technology (“Georgia Tech”).

15. Georgia Tech is a leading public research university located in Atlanta, Georgia. Founded in 1885, Georgia Tech is often ranked as one of the top ten public universities in the United States. The patents from Georgia Tech (“the Mody patents”) were developed by a professor and a graduate student in Georgia Tech’s Electrical and Computer Engineering

department. The undergraduate and graduate programs of this department are often ranked in the top five of their respective categories.

16. The Mody patents are related to Multi-Input, Multi-Output (MIMO) technology. The inventors of the Mody patents were at the forefront of MIMO, developing, disclosing, and patenting a solution for achieving both time and frequency synchronization in MIMO systems. The Mody patents (or the applications leading to them) have been cited during patent prosecution hundreds of times, by numerous leading companies in the computing and communications industries, including AMD, Alcatel Lucent, Altair, AT&T, Atheros, Blackberry, Broadcom, Comcast, Ericsson, Facebook, HP, Hitachi, Huawei, Infineon, Intel, Interdigital, IBM, Kyocera, Marvell, Matsushita, Mediatek, Motorola, NEC, Nokia, Nortel Networks, NXP, Panasonic, Philips, Qualcomm, Realtek, Samsung, Sanyo, Sharp, Sony, STMicroelectronics, Texas Instruments, and Toshiba.

COUNT I

INFRINGEMENT OF U.S. PATENT NO. 7,088,782

17. On August 8, 2006, United States Patent No. 7,088,782 (“the ‘782 Patent”) was duly and legally issued by the United States Patent and Trademark Office for an invention entitled “Time And Frequency Synchronization In Multi-Input, Multi-Output (MIMO) Systems.”

18. American Patents is the owner of the ‘782 Patent, with all substantive rights in and to that patent, including the sole and exclusive right to prosecute this action and enforce the ‘782 Patent against infringers, and to collect damages for all relevant times.

19. MediaTek used products and/or systems including, for example, its MediaTek MT7915 Wi-Fi Wave 1+ chipset (with 2x2 MIMO), MediaTek MT8167S Wireless Connected Multimedia Solution (with 2x2 MIMO), and MediaTek Dimensity 9000 chipset (with 2x2

MIMO) families of products that include 802.11n and above capabilities and/or LTE capabilities (“accused products”):



(Source : <https://www.mediatek.com/blog/mediatek-mt7915-wi-fi-6-wave-1-chipset-builds-in-a-range-of-industry-firsts>)



(Source : <https://www.mediatek.com/products/home-networking/mt8167s>)

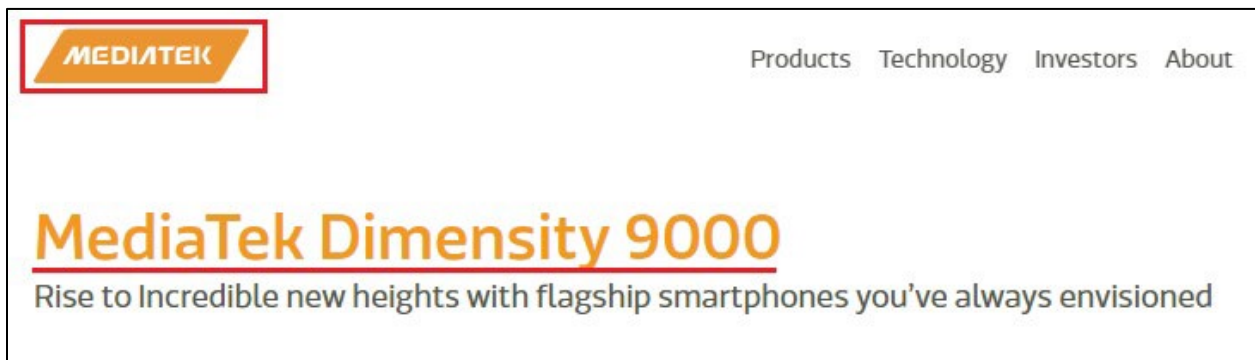

(Source : <https://www.mediatek.com/products/smartphones-2/mediatek-dimension-9000>)



Wi-Fi CERTIFIED™ Certificate

This certificate lists the features that have successfully completed Wi-Fi Alliance interoperability testing. Learn more: www.wi-fi.org/certification/programs

Certification ID: WFA93165

Product Info	
Date of Certification	December 1, 2021
Company	MediaTek Inc.
Product Name	MT7915
Product Model Variant	QoS update
Model Number	MT7915
Category	Other
Sub-category	Embedded Module

(Source : <https://api.cert.wi-fi.org/api/certificate/download/public?variantId=109842>)

Connectivity	2.4 GHz Spectrum Capabilities
	5 GHz Spectrum Capabilities
	6 GHz Spectrum Capabilities
	Wi-Fi CERTIFIED 6™
	Wi-Fi CERTIFIED™ a
	Wi-Fi CERTIFIED™ ac
	Wi-Fi CERTIFIED™ b
	Wi-Fi CERTIFIED™ g
	Wi-Fi CERTIFIED™ n
	Wi-Fi Enhanced Open™ 2021-01

(Source : <https://api.cert.wi-fi.org/api/certificate/download/public?variantId=109842>)

Connectivity	2.4 GHz Spectrum Capabilities
	5 GHz Spectrum Capabilities
	6 GHz Spectrum Capabilities
	Wi-Fi CERTIFIED 6™
	Wi-Fi CERTIFIED™ a
	Wi-Fi CERTIFIED™ ac
	Wi-Fi CERTIFIED™ b
	Wi-Fi CERTIFIED™ g
	Wi-Fi CERTIFIED™ n
	Wi-Fi Enhanced Open™ 2021-01

(Source : <https://api.cert.wi-fi.org/api/certificate/download/public?variantId=109842>)

Connectivity
IEEE 802.11 Wi-Fi 5 (a/b/g/n/ac)
Wi-Fi Frequency 2.4GHz, 5GHz
Antenna 2T2R
Bluetooth 5.0

(Source : <https://www.mediatek.com/products/home-networking/mt8167s>)

Connectivity

Cellular Technologies
2G-5G Multi-Mode, 5G/4G CA, 5G/4G FDD / TDD, CDMA2000 1x/EVDO Rev. A (SRLTE), EDGE, GSM, TD-SCDMA, WCDMA

Specific Functions
5G/4G Dual SIM Dual Active, SA & NSA modes; SA Option2, NSA Option3 / 3a / 3x, NR TDD and FDD bands, DSS, NR DL 3CC, 300MHz bandwidth, 4x4 MIMO, 256QAM NR UL 2CC, R16 UL Enhancement, 2x2 MIMO, 256QAM VoNR / EPS fallback

Peak Download / Upload Speed
7Gbps / 2.5Gbps

GNSS
GPS L1CA+L5 / BeiDou B1I+ B2a + B1C / Glonass L10F / Galileo E1 + E5a / QZSS L1CA+ L5 / NavIC

Wi-Fi
Wi-Fi 6E (a/b/g/n/ac/ax)

Wi-Fi Antenna
2T2R

Bluetooth
5.3

(Source : <https://www.mediatek.com/products/smartphones-2/mediatek-dimension-9000>)

20. By doing so, MediaTek has directly infringed (literally and/or under the doctrine of equivalents) at least Claim 30 of the '782 Patent. MediaTek's infringement in this regard is ongoing.

21. MediaTek has infringed the '782 Patent by using the accused products and thereby practicing a method for synchronizing a Multi-Input Multi-Output (MIMO) Orthogonal Frequency Division Multiplexing (OFDM) system in time and frequency domains. For example, the accused products support IEEE 802.11 n/ac standards and MIMO technology. According to

the IEEE 802.11n standard, the PLCP Protocol Data Unit (PPDU) has training fields and signaling fields for helping in synchronizing the communication system.

Connectivity	2.4 GHz Spectrum Capabilities
	5 GHz Spectrum Capabilities
	6 GHz Spectrum Capabilities
	Wi-Fi CERTIFIED 6™
	Wi-Fi CERTIFIED™ a
	Wi-Fi CERTIFIED™ ac
	Wi-Fi CERTIFIED™ b
	Wi-Fi CERTIFIED™ g
	Wi-Fi CERTIFIED™ n
	Wi-Fi Enhanced Open™ 2021-01

(Source : <https://api.cert.wi-fi.org/api/certificate/download/public?variantId=109842>)

Connectivity	2.4 GHz Spectrum Capabilities
	5 GHz Spectrum Capabilities
	6 GHz Spectrum Capabilities
	Wi-Fi CERTIFIED 6™
	Wi-Fi CERTIFIED™ a
	Wi-Fi CERTIFIED™ ac
	Wi-Fi CERTIFIED™ b
	Wi-Fi CERTIFIED™ g
	Wi-Fi CERTIFIED™ n
	Wi-Fi Enhanced Open™ 2021-01

(Source : <https://api.cert.wi-fi.org/api/certificate/download/public?variantId=109842>)

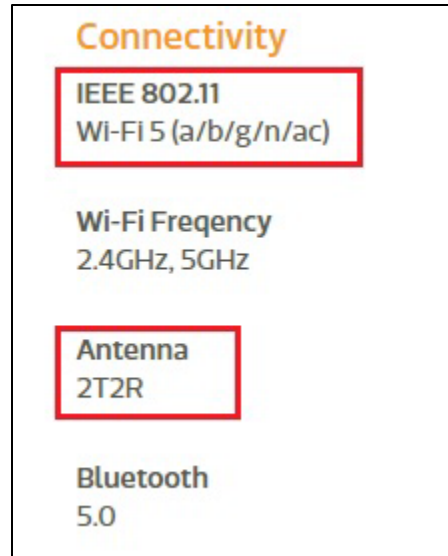

(Source : <https://www.mediatek.com/products/home-networking/mt8167s>)

Connectivity

Cellular Technologies

2G-5G Multi-Mode, 5G/4G CA, 5G/4G FDD / TDD, CDMA2000 1x/EVDO Rev. A (SRLTE), EDGE, GSM, TD-SCDMA, WCDMA

Specific Functions

5G/4G Dual SIM Dual Active, SA & NSA modes; SA Option2, NSA Option3 / 3a / 3x, NR TDD and FDD bands, DSS, NR DL 3CC, 300MHz bandwidth, 4x4 MIMO, 256QAM NR UL 2CC, R16 UL Enhancement, 2x2 MIMO, 256QAM VoNR / EPS fallback

Peak Download / Upload Speed

7Gbps / 2.5Gbps

GNSS

GPS L1CA+L5 / BeiDou B1I+ B2a + B1C / Glonass L10F / Galileo E1 + E5a / QZSS L1CA+ L5 / NavIC

Wi-Fi

Wi-Fi 6E (a/b/g/n/ac/ax)

Wi-Fi Antenna

2T2R

Bluetooth

5.3

(Source : <https://www.mediatek.com/products/smartphones-2/mediatek-dimension-9000>)

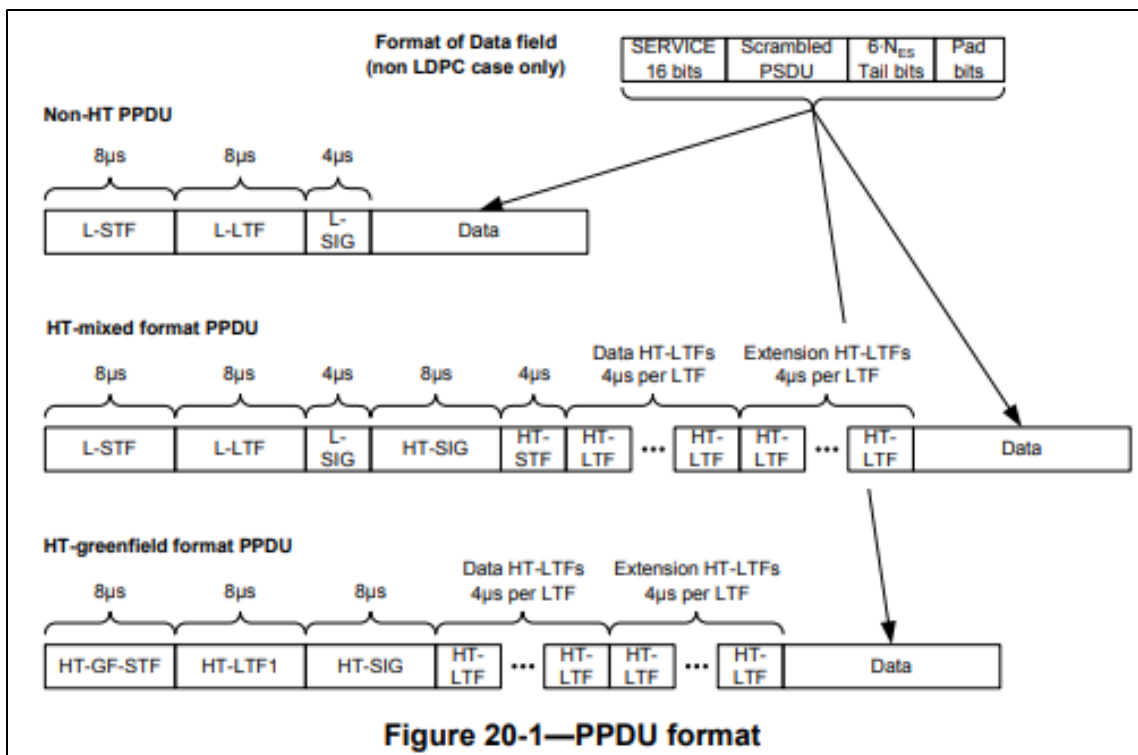

(Source: <https://web.archive.org/web/20190220214328/http://luci.subsignal.org/~jow/802.11n-2009.pdf>)

Table 20-4—Elements of the HT PLCP packet

Element	Description
L-STF	Non-HT Short Training field
L-LTF	Non-HT Long Training field
L-SIG	Non-HT SIGNAL field
HT-SIG	HT SIGNAL field
HT-STF	HT Short Training field
HT-GF-STF	HT-Greenfield Short Training field
HT-LTF1	First HT Long Training field (Data)
HT-LTFs	Additional HT Long Training fields (Data and Extension)
Data	The Data field includes the PSDU

(Source: <https://web.archive.org/web/20190220214328/http://luci.subsignal.org/~jow/802.11n-2009.pdf>)

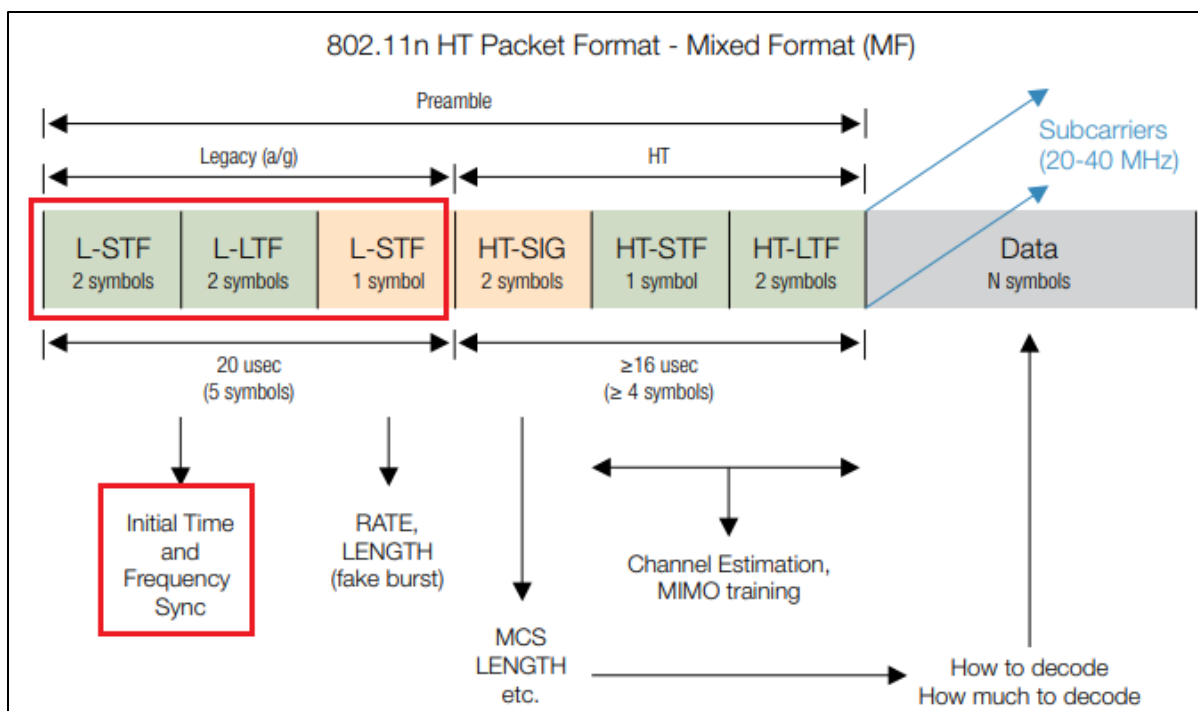

(Source: <https://www.cnrood.com/en/media/solutions/Wi-Fi-Overview-of-the-802.11-Physical-Layer.pdf>)

22. The methods practiced by MediaTek's use of the accused products include producing a frame of data comprising a training symbol that includes a synchronization component that aids in synchronization, a plurality of data symbols, and a plurality of cyclic prefixes. For example, as part of the 802.11n standard, three preamble formats are defined for frames: non-HT, HT-mixed format and HT-greenfield format. The non-HT, HT-mixed, and HT-greenfield format preambles consist of training symbols, data symbols and guard intervals/cyclic prefixes, and the training symbols (L-STF, L-LTF, and other LTF and STF fields) are and have been used for frame synchronization. According to the IEEE 802.11n standard, all Protocol Data Unit (PPDU) frame formats have training fields and signaling fields which would help in synchronizing the communication system. Alternatively, on request from accused products, an 802.11 n/ac compliant WiFi access point can act as a transmitter and perform the step of

producing a frame of data comprising a training symbol that includes a synchronization component that aids in synchronization, a plurality of data symbols, and a plurality of cyclic prefixes.

Two preamble formats are defined. For HT-mixed format operation, the preamble has a non-HT portion and an HT portion. The non-HT portion of the HT-mixed format preamble enables detection of the PPDU and acquisition of carrier frequency and timing by both HT STAs and STAs that are compliant with Clause 17 and/or Clause 19. The non-HT portion of the HT-mixed format preamble also consists of the SIGNAL field defined in Clause 17 and is thus decodable by STAs compliant with Clause 17 and Clause 19 as well as HT STAs.

The HT portion of the HT-mixed format preamble enables estimation of the MIMO channel to support demodulation of the HT data by HT STAs. The HT portion of the HT-mixed format preamble also includes the HT-SIG field, which supports HT operation. The SERVICE field is prepended to the PSDU.

(Source: <https://web.archive.org/web/20190220214328/http://luci.subsignal.org/~jow/802.11n-2009.pdf>)

- a) Determine the number of transmit chains, N_{TX} , from the N_TX field of the TXVECTOR. Produce the PLCP preamble training fields for each of the N_{TX} transmit chains based on the FORMAT, NUM_EXTEN_SS, CH_BANDWIDTH, and MCS parameters of the TXVECTOR. The format and relative placement of the PLCP preamble training fields vary depending on the frame format being used, as indicated by these parameters. Apply cyclic shifts. Determine spatial mapping to be used for HT-STF and HT-LTFs in HT-mixed format frame and HT-GF-STF and HT-LTFs in HT-greenfield format frame from the EXPANSION_MAT parameter of the TXVECTOR. Refer to 20.3.9 for details.
- b) Construct the PLCP preamble SIGNAL fields from the appropriate fields of the TXVECTOR by adding tail bits, applying convolutional coding, formatting into one or more OFDM symbols, applying cyclic shifts, applying spatial processing, calculating an inverse Fourier transform for each OFDM symbol and transmit chain, and prepending a cyclic prefix or GI to each OFDM symbol in each transmit chain. The number and placement of the PLCP preamble SIGNAL fields depend on the frame format being used. Refer to 20.3.9.3.5, 20.3.9.4.3, and 20.3.9.5.3.
- c) Concatenate the PLCP preamble training and SIGNAL fields for each transmit chain one field after another, in the appropriate order, as described in 20.3.2 and 20.3.7.

(Source: <https://web.archive.org/web/20190220214328/http://luci.subsignal.org/~jow/802.11n-2009.pdf>)

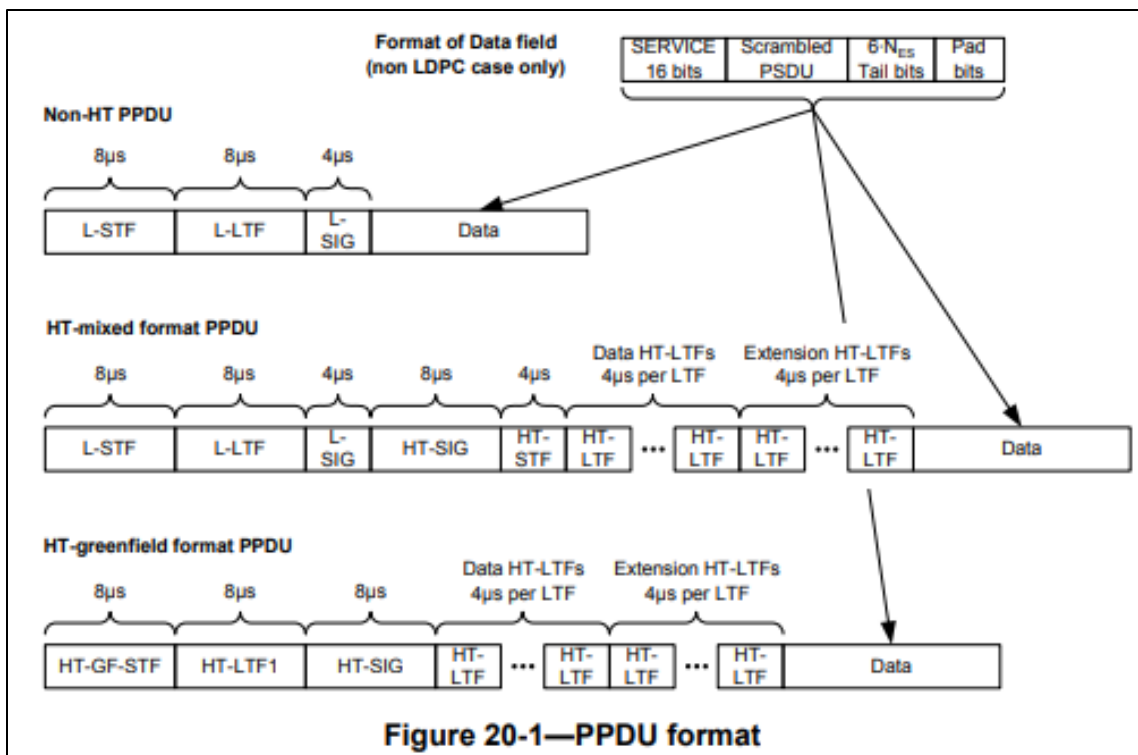

(Source: <https://web.archive.org/web/20190220214328/http://luci.subsignal.org/~jow/802.11n-2009.pdf>)

Table 20-4—Elements of the HT PLCP packet

Element	Description
L-STF	Non-HT Short Training field
L-LTF	Non-HT Long Training field
L-SIG	Non-HT SIGNAL field
HT-SIG	HT SIGNAL field
HT-STF	HT Short Training field
HT-GF-STF	HT-Greenfield Short Training field
HT-LTF1	First HT Long Training field (Data)
HT-LTFs	Additional HT Long Training fields (Data and Extension)
Data	The Data field includes the PSDU

(Source: <https://web.archive.org/web/20190220214328/http://luci.subsignal.org/~jow/802.11n-2009.pdf>)

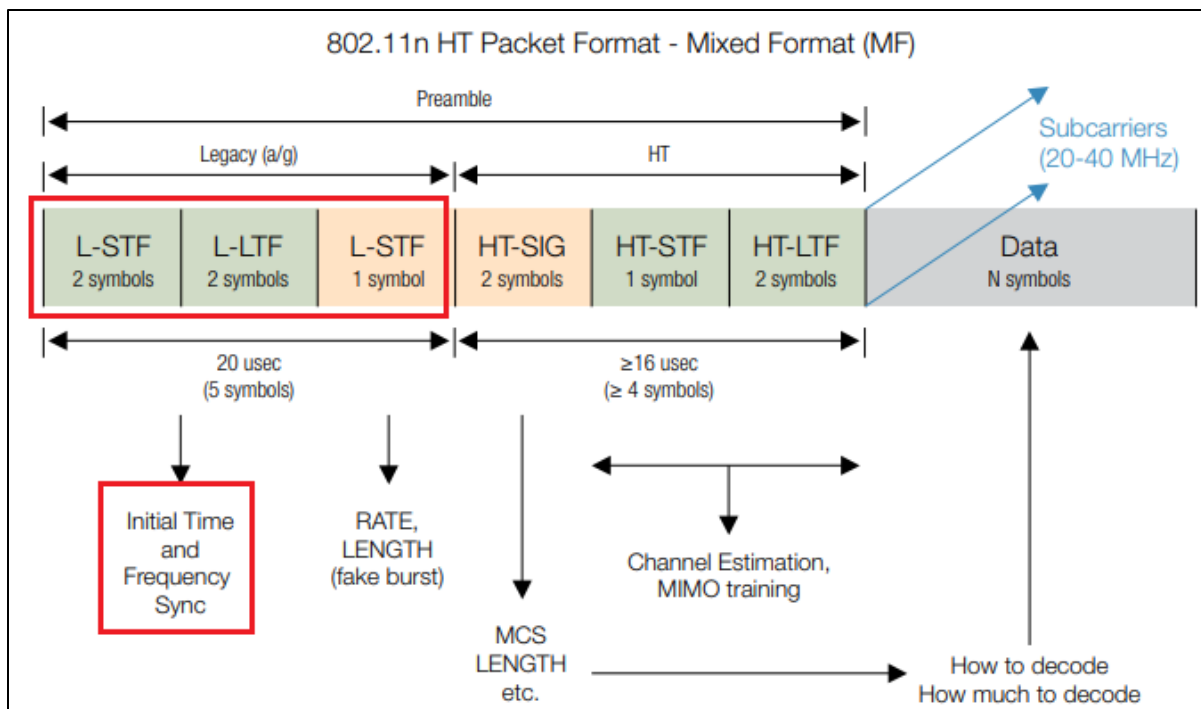

(Source: <https://www.cnrood.com/en/media/solutions/Wi-Fi-Overview-of-the-802.11-Physical-Layer.pdf>)

GI_TYPE	FORMAT is HT_MF or HT_GF	Indicates whether a short guard interval is used in the transmission of the packet. Enumerated type: LONG_GI indicates short GI is not used in the packet. SHORT_GI indicates short GI is used in the packet.	Y	Y
	Otherwise	Not present	N	N

(Source: <https://web.archive.org/web/20190220214328/http://luci.subsignal.org/~jow/802.11n-2009.pdf>)

23. The methods practiced by MediaTek’s use of the accused products include transmitting the frame over a channel. The data frames containing the preambles are transmitted using one or more transmitting antennas. Alternatively, on request from an accused product, an 802.11 n/ac compliant WiFi access point can act as a transmitter and transmit the frame over a channel using one or more transmitting antennas.

20.3.9 HT preamble

20.3.9.1 Introduction

The HT preambles are defined in HT-mixed format and in HT-greenfield format to carry the required information to operate in a system with multiple transmit and multiple receive antennas.

In the HT-mixed format, to ensure compatibility with non-HT STAs, specific non-HT fields are defined so that they can be received by non-HT STAs compliant with Clause 17 or Clause 19 followed by the fields specific to HT STAs.

(Source: <https://web.archive.org/web/20190220214328/http://luci.subsignal.org/~jow/802.11n-2009.pdf>)

20.3.10 Transmission of NON_HT format PPDU with more than one antenna

When an HT device transmits a NON_HT format PPDU with the MODULATION parameter set to OFDM or ERP-OFDM using more than one transmit chain, it shall apply the cyclic shifts defined in Table 20-8 to the transmission in each chain.

(Source: <https://web.archive.org/web/20190220214328/http://luci.subsignal.org/~jow/802.11n-2009.pdf>)

24. The methods practiced by MediaTek's use of the accused products include receiving the transmitted frame. For example, the receiving antennas of the accused products can receive the transmitted frames for further processing.

20.3.24 PLCP receive procedure

Typical PLCP receive procedures are shown in Figure 20-23 and Figure 20-24. The receive procedures correspond to HT-mixed format and HT-greenfield format, respectively. A typical state machine implementation of the receive PLCP is given in Figure 20-25. These receive procedures and state machine do not describe the operation of optional features, such as LDPC or STBC. If the detected format indicates a non-HT PPDU format, refer to the receive procedure and state machine in Clause 17 or Clause 19. Further, through station management (via the PLME), the PHY is set to the appropriate frequency, as specified in 20.4. Other receive parameters, such as RSSI and indicated DATARATE, may be accessed via the PHY-SAP.

(Source: <https://web.archive.org/web/20190220214328/http://luci.subsignal.org/~jow/802.11n-2009.pdf>)

25. The methods practiced by MediaTek's use of the accused products include demodulating the received frame. For example, the received data frames are demodulated using the PLCP preambles.

20.3 HT PLCP sublayer

20.3.1 Introduction

A convergence procedure, in which PSDUs are converted to and from PPDU, is provided for the HT PHY in 20.3. During transmission, the PSDU is processed (i.e., scrambled and coded) and appended to the PLCP preamble to create the PPDU. At the receiver, the PLCP preamble is processed to aid in demodulation and delivery of the PSDU.

(Source: <https://web.archive.org/web/20190220214328/http://luci.subsignal.org/~jow/802.11n-2009.pdf>)

26. The methods practiced by MediaTek's use of the accused products include synchronizing the received demodulated frame to the transmitted frame such that the data symbols are synchronized in the time domain and frequency domain. For example, different fields of data like training symbols, cyclic prefixes and other signal bits are present in the received frame. The training symbols (L-STF and L-LTF fields) help in synchronizing the frame in both the time domain and frequency domain.

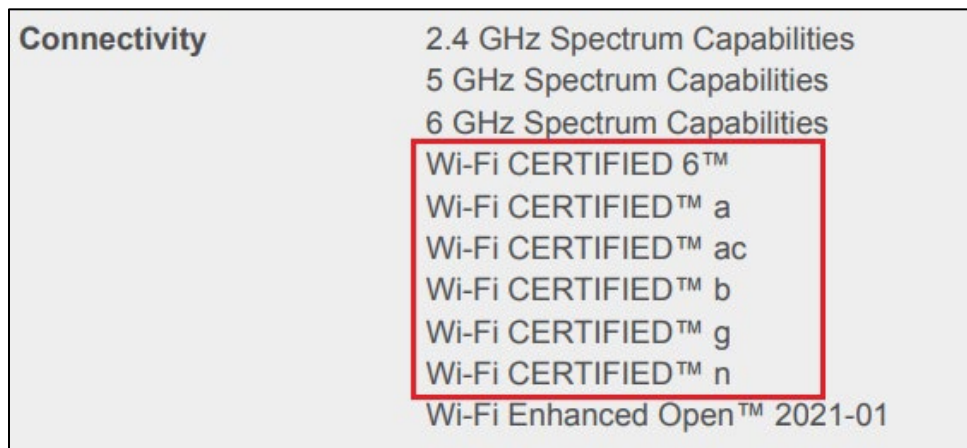

(Source : <https://api.cert.wi-fi.org/api/certificate/download/public?variantId=109842>)

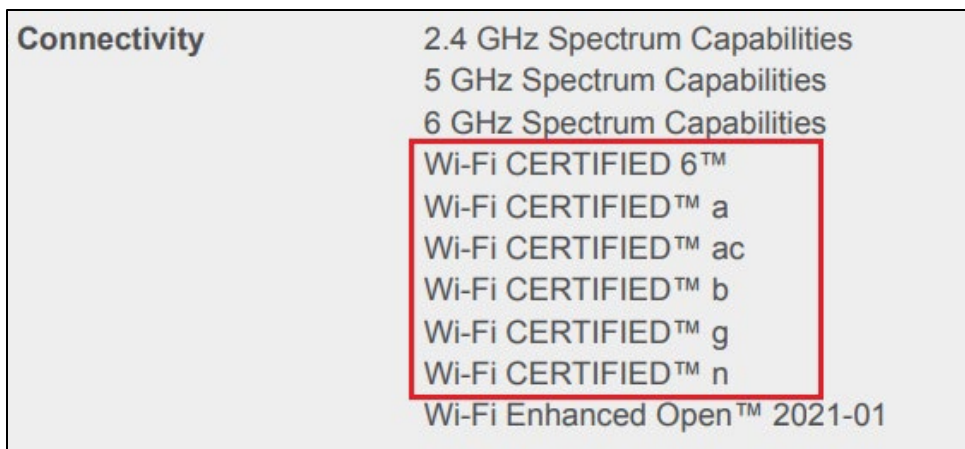

(Source : <https://api.cert.wi-fi.org/api/certificate/download/public?variantId=109842>)

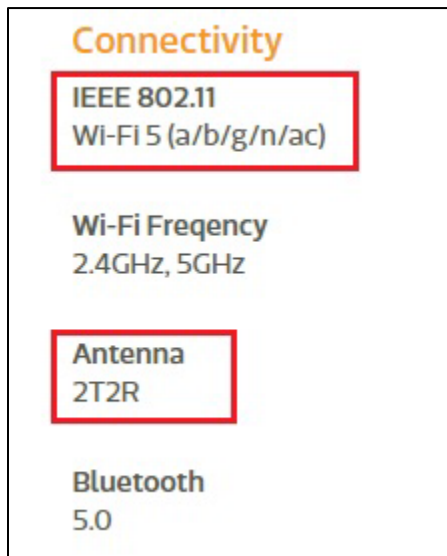

(Source : <https://www.mediatek.com/products/home-networking/mt8167s>)

Connectivity

Cellular Technologies

2G-5G Multi-Mode, 5G/4G CA, 5G/4G FDD / TDD, CDMA2000 1x/EVDO Rev. A (SRLTE), EDGE, GSM, TD-SCDMA, WCDMA

Specific Functions

5G/4G Dual SIM Dual Active, SA & NSA modes; SA Option2, NSA Option3 / 3a / 3x, NR TDD and FDD bands, DSS, NR DL 3CC, 300MHz bandwidth, 4x4 MIMO, 256QAM NR UL 2CC, R16 UL Enhancement, 2x2 MIMO, 256QAM VoNR / EPS fallback

Peak Download / Upload Speed

7Gbps / 2.5Gbps

GNSS

GPS L1CA+L5 / BeiDou B1I+ B2a + B1C / Glonass L10F / Galileo E1 + E5a / QZSS L1CA+ L5 / NavIC

Wi-Fi

Wi-Fi 6E (a/b/g/n/ac/ax)

Wi-Fi Antenna

2T2R

Bluetooth

5.3

(Source : <https://www.mediatek.com/products/smartphones-2/mediatek-dimension-9000>)

- a) Determine the number of transmit chains, N_{TX} , from the N_TX field of the TXVECTOR. Produce the PLCP preamble training fields for each of the N_{TX} transmit chains based on the FORMAT, NUM_EXTEN_SS, CH_BANDWIDTH, and MCS parameters of the TXVECTOR. The format and relative placement of the PLCP preamble training fields vary depending on the frame format being used, as indicated by these parameters. Apply cyclic shifts. Determine spatial mapping to be used for HT-STF and HT-LTFs in HT-mixed format frame and HT-GF-STF and HT-LTFs in HT-greenfield format frame from the EXPANSION_MAT parameter of the TXVECTOR. Refer to 20.3.9 for details.
- b) Construct the PLCP preamble SIGNAL fields from the appropriate fields of the TXVECTOR by adding tail bits, applying convolutional coding, formatting into one or more OFDM symbols, applying cyclic shifts, applying spatial processing, calculating an inverse Fourier transform for each OFDM symbol and transmit chain, and prepending a cyclic prefix or GI to each OFDM symbol in each transmit chain. The number and placement of the PLCP preamble SIGNAL fields depend on the frame format being used. Refer to 20.3.9.3.5, 20.3.9.4.3, and 20.3.9.5.3.
- c) Concatenate the PLCP preamble training and SIGNAL fields for each transmit chain one field after another, in the appropriate order, as described in 20.3.2 and 20.3.7.

(Source: <https://web.archive.org/web/20190220214328/http://luci.subsignal.org/~jow/802.11n-2009.pdf>)

20.3.21.7.4 Transmitter modulation accuracy (EVM) test

The transmit modulation accuracy test shall be performed by instrumentation capable of converting the transmitted signals into a streams of complex samples at 40 Msample/s or more, with sufficient accuracy in terms of I/Q arm amplitude and phase balance, dc offsets, phase noise, and analog-to-digital quantization noise. Each transmit chain is connected directly through a cable to the setup input port. A possible embodiment of such a setup is converting the signals to a low intermediate frequency with a microwave synthesizer, sampling the signal with a digital oscilloscope, and decomposing it digitally into quadrature components. The sampled signal shall be processed in a manner similar to an actual receiver, according to the following steps, or an equivalent procedure:

- a) Detect the start of frame.
- b) Detect the transition from short sequences to channel estimation sequences, and establish fine timing (with one sample resolution).
- c) Estimate the coarse and fine frequency offsets.
- d) Derotate the frame according to estimated frequency offset.
- e) Estimate the complex channel response coefficients for each of the subcarriers and each of the transmit chains.
- f) For each of the data OFDM symbols, transform the symbol into subcarrier received values, estimate the phase from the pilot subcarriers in all spatial streams, derotate the subcarrier values according to estimated phase, group the results from all the receiver chains in each subcarrier to a vector, multiply the vector by a zero-forcing equalization matrix generated from the channel estimated during the channel estimation phase.
- g) For each data-carrying subcarrier in each spatial stream, find the closest constellation point and compute the Euclidean distance from it.
- h) Compute the average of the RMS of all errors in a frame. It is given by Equation (20-89).

(Source: <https://web.archive.org/web/20190220214328/http://luci.subsignal.org/~jow/802.11n-2009.pdf>)

17.3.2.1 Overview of the PPDU encoding process

The encoding process is composed of many detailed steps, which are described fully in later subclauses, as noted below. The following overview intends to facilitate understanding the details of the convergence procedure:

- a) Produce the PLCP Preamble field, composed of 10 repetitions of a “short training sequence” (used for AGC convergence, diversity selection, timing acquisition, and coarse frequency acquisition in the receiver) and two repetitions of a “long training sequence” (used for channel estimation and fine frequency acquisition in the receiver), preceded by a guard interval (GI). Refer to 17.3.3 for details.

(Source: <https://www.iith.ac.in/~tbr/teaching/docs/802.11-2007.pdf>)

27. The methods practiced by MediaTek's use of the accused products include wherein the synchronizing in the time domain comprises coarse time synchronizing and fine time synchronizing. For example, the demodulation of PPDU frames also includes detecting training field bits and establishing a timing synchronization. This time synchronization would include both coarse and fine time synchronization. In general, coarse time synchronization is done using L-STF field and fine time synchronization is done using L-LTF field present in the preamble.

20.3.21.7.4 Transmitter modulation accuracy (EVM) test

The transmit modulation accuracy test shall be performed by instrumentation capable of converting the transmitted signals into a streams of complex samples at 40 Msample/s or more, with sufficient accuracy in terms of I/Q arm amplitude and phase balance, dc offsets, phase noise, and analog-to-digital quantization noise. Each transmit chain is connected directly through a cable to the setup input port. A possible embodiment of such a setup is converting the signals to a low intermediate frequency with a microwave synthesizer, sampling the signal with a digital oscilloscope, and decomposing it digitally into quadrature components. The sampled signal shall be processed in a manner similar to an actual receiver, according to the following steps, or an equivalent procedure:

- a) Detect the start of frame.
- b) Detect the transition from short sequences to channel estimation sequences, and establish fine timing (with one sample resolution).
- c) Estimate the coarse and fine frequency offsets.
- d) Derotate the frame according to estimated frequency offset.
- e) Estimate the complex channel response coefficients for each of the subcarriers and each of the transmit chains.
- f) For each of the data OFDM symbols, transform the symbol into subcarrier received values, estimate the phase from the pilot subcarriers in all spatial streams, derotate the subcarrier values according to estimated phase, group the results from all the receiver chains in each subcarrier to a vector, multiply the vector by a zero-forcing equalization matrix generated from the channel estimated during the channel estimation phase.
- g) For each data-carrying subcarrier in each spatial stream, find the closest constellation point and compute the Euclidean distance from it.
- h) Compute the average of the RMS of all errors in a frame. It is given by Equation (20-89).

(Source: <https://web.archive.org/web/20190220214328/http://luci.subsignal.org/~jow/802.11n-2009.pdf>)

The simplest packet is the one used when operating in the legacy mode, which has the same format as the packets used in 802.11a/g. The L-STF field, which stands for the *legacy-short training field*, consists of two augmented OFDM symbols of 4 μ s duration each, and these are used by the receiver to perform time and frequency synchronization and to adjust its AGC. After the two L-STF augmented OFDM symbols, there is a second field called L-LTF, which stands for *legacy-long training field*, which is used to perform fine timing adjustments after the initial coarse acquisition in the L-STF field. The third field, called L-SIG, which stands for *legacy signal field*, contains data that tell the receiver what modulation and coding will be used in the data portion of the packet. The L-SIG field consists of one augmented OFDM symbol.

(Source: Introduction to MIMO Communications, Hampton, Jerry R. (2014))

Receive procedure

Typically, the receiver waits for a signal to exceed a threshold before initiating the packet reception procedure. The minimum requirement in 802.11a is to detect the start of a valid transmission received at a power level of at least -82 dBm within 4 μ s with a probability greater than 90%. Due to competitive pressures, most products exceed this specification by 5–10 dB.

The short training symbols are processed to set the AGC, initial frequency correction, and initial timing acquisition. This is followed by processing the long training symbols for fine frequency correction and fine timing adjustment. The LTF is also used to generate the channel estimate.

(Source: Next Generation Wireless LANs: 802.11n and 802.11ac, Perahia, Eldad and Stacey, Robert)

28. MediaTek has directly infringed at least through its use of the accused products through its own testing of the accused products, and through joint infringement with its affiliates, with its subsidiaries, with carriers, with retailers and other sales entities, with its business partners, with certification organizations, with testing organizations, with other agents of MediaTek, and/or with its customers and end-users, at least using the claimed method. Such acts of infringement include directing or controlling other persons to engage in conduct satisfying one

or more elements of the asserted claims, deriving a financial or other benefit from doing so. MediaTek's direction or control of its affiliates and end-users includes regularly contracting with those affiliates and end-users. Also, as explained further below, MediaTek took active steps and advised or directed customers and end-users to use the accused products in an infringing manner.

29. MediaTek has had actual knowledge of the '782 Patent at least as of the date when it was notified of the filing of this action. By the time of trial, MediaTek will have known and intended (since receiving such notice) that its continued actions would infringe and actively induce and contribute to the infringement of one or more claims of the '782 Patent.

30. MediaTek has also indirectly and willfully infringed, and continues to indirectly and willfully infringe, the '782 Patent, as explained further below in the "Additional Allegations Regarding Infringement" section.

31. American Patents has been damaged as a result of the infringing conduct by MediaTek alleged above. Thus, MediaTek is liable to American Patents in an amount that adequately compensates it for such infringements, which, by law, cannot be less than a reasonable royalty, together with interest and costs as fixed by this Court under 35 U.S.C. § 284.

32. American Patents has neither made nor sold unmarked articles that practice the '782 Patent, and is entitled to collect pre-filing damages for the full period allowed by law for infringement of the '782 Patent.

COUNT II

INFRINGEMENT OF U.S. PATENT NO. 7,310,304

33. On December 18, 2007, United States Patent No. 7,310,304 (“the ‘304 Patent”) was duly and legally issued by the United States Patent and Trademark Office for an invention entitled “Estimating Channel Parameters in Multi-Input, Multi-Output (MIMO) Systems.”

34. American Patents is the owner of the ‘304 Patent, with all substantive rights in and to that patent, including the sole and exclusive right to prosecute this action and enforce the ‘304 Patent against infringers, and to collect damages for all relevant times.

35. MediaTek made, had made, used, imported, provided, supplied, distributed, sold, and/or offered for sale products and/or systems including, for example, its MediaTek MT7915 Wi-Fi Wave 1+ chipset (with 2x2 MIMO), MediaTek MT8167S Wireless Connected Multimedia Solution (with 2x2 MIMO), and MediaTek Dimensity 9000 chipset (with 2x2 MIMO) families of products that include 802.11n and above capabilities and/or LTE capabilities (“accused products”):



(Source : <https://www.mediatek.com/blog/mediatek-mt7915-wi-fi-6-wave-1-chipset-builds-in-a-range-of-industry-firsts>)



(Source : <https://www.mediatek.com/products/home-networking/mt8167s>)

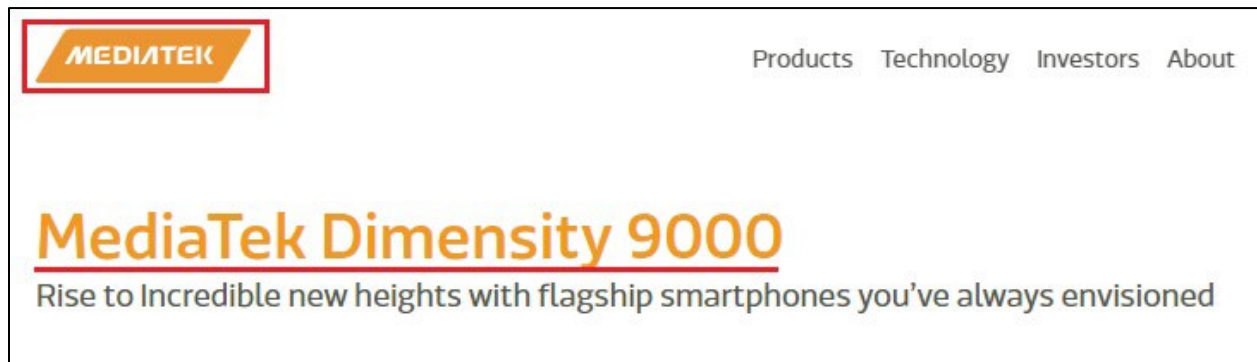

(Source : <https://www.mediatek.com/products/smartphones-2/mediatek-dimensity-9000>)



Wi-Fi CERTIFIED™ Certificate

This certificate lists the features that have successfully completed Wi-Fi Alliance interoperability testing. Learn more: www.wi-fi.org/certification/programs



Certification ID: WFA93165

Product Info	
Date of Certification	December 1, 2021
Company	MediaTek Inc.
Product Name	MT7915
Product Model Variant	QoS update
Model Number	MT7915
Category	Other
Sub-category	Embedded Module

(Source : <https://api.cert.wi-fi.org/api/certificate/download/public?variantId=109842>)

Connectivity	2.4 GHz Spectrum Capabilities
	5 GHz Spectrum Capabilities
	6 GHz Spectrum Capabilities
	Wi-Fi CERTIFIED 6™
	Wi-Fi CERTIFIED™ a
	Wi-Fi CERTIFIED™ ac
	Wi-Fi CERTIFIED™ b
	Wi-Fi CERTIFIED™ g
Wi-Fi CERTIFIED™ n	
Wi-Fi Enhanced Open™ 2021-01	

(Source : <https://api.cert.wi-fi.org/api/certificate/download/public?variantId=109842>)

Connectivity	2.4 GHz Spectrum Capabilities
	5 GHz Spectrum Capabilities
	6 GHz Spectrum Capabilities
	Wi-Fi CERTIFIED 6™
	Wi-Fi CERTIFIED™ a
	Wi-Fi CERTIFIED™ ac
	Wi-Fi CERTIFIED™ b
	Wi-Fi CERTIFIED™ g
Wi-Fi CERTIFIED™ n	
Wi-Fi Enhanced Open™ 2021-01	

(Source : <https://api.cert.wi-fi.org/api/certificate/download/public?variantId=109842>)

Connectivity
IEEE 802.11 Wi-Fi 5 (a/b/g/n/ac)
Wi-Fi Frequency 2.4GHz, 5GHz
Antenna 2T2R
Bluetooth 5.0

(Source : <https://www.mediatek.com/products/home-networking/mt8167s>)

Connectivity

Cellular Technologies
2G-5G Multi-Mode, 5G/4G CA, 5G/4G FDD / TDD, CDMA2000 1x/EVDO Rev. A (SRLTE), EDGE, GSM, TD-SCDMA, WCDMA

Specific Functions
5G/4G Dual SIM Dual Active, SA & NSA modes; SA Option2, NSA Option3 / 3a / 3x, NR TDD and FDD bands, DSS, NR DL 3CC, 300MHz bandwidth, 4x4 MIMO, 256QAM NR UL 2CC, R16 UL Enhancement, 2x2 MIMO, 256QAM VoNR / EPS fallback

Peak Download / Upload Speed
7Gbps / 2.5Gbps

GNSS
GPS L1CA+L5 / BeiDou B1I+ B2a + B1C / Glonass L10F / Galileo E1 + E5a / QZSS L1CA+ L5 / NavIC

Wi-Fi
Wi-Fi 6E (a/b/g/n/ac/ax)

Wi-Fi Antenna
2T2R

Bluetooth
5.3

(Source : <https://www.mediatek.com/products/smartphones-2/mediatek-dimension-9000>)

36. By doing so, MediaTek has directly infringed (literally and/or under the doctrine of equivalents) at least Claim 1 of the '304 Patent. MediaTek's infringement in this regard is ongoing.

37. MediaTek has infringed the '304 Patent by making, having made, using, importing, providing, supplying, distributing, selling or offering for sale products including an Orthogonal Frequency Division Multiplexing (OFDM) transmitter. For example, the accused

products support IEEE 802.11 n/ac standards and MIMO technology. The IEEE 802.11n standard “uses OFDM modulation to transmit all data.”

The 802.11n-2009 wireless LAN standard provides Higher Throughput (HT) rates. These higher rates are achieved by a combination of MAC and PHY layer enhancements. The enhancements include:

- Reducing the per-packet overhead in the MAC layer.
- Allowing multiple MAC packets to be combined into a single PHY-layer burst.
- Allowing (optionally) a more efficient LDPC encoder.
- Allowing (optionally) a shorter guard interval (cyclic prefix) on the data symbols.
- Increasing the number of subcarriers used in the default 20 MHz physical channel.
- Providing an (optional) 40 MHz mode.
- Using MIMO techniques to broadcast multiple data streams over a single frequency channel.

By combining these techniques, the goal is to increase the usable data transfer rate by a factor of 10.

Signal Characteristics

The 802.11n standard uses OFDM modulation to transmit all data. It defines three operating modes:

(Source: http://rfmw.em.keysight.com/wireless/helpfiles/89600b/webhelp/subsystems/wlan-mimo/Content/mimo_80211n_overview.htm)

38. The accused products include an encoder configured to process data to be transmitted within an OFDM system, the encoder further configured to separate the data onto one or more transmit diversity branches (TDBs). For example, the 802.11 ac standard is backwards compatible with 802.11n and 802.11a. Thus, if a device, such as an accused product, implements 802.11ac, then it also supports 802.11n and all previous versions of the WiFi standards (i.e., IEEE 802.11 a/b/g/n). According to the IEEE 802.11n standard, an encoder block is present in a transmitter section of general OFDM systems. The encoder(s) output(s) the data onto multiple transmit chains (transmit diversity branches) for further processing.

The introduction of 802.11ac expands the compatibility matrix in the 5 GHz band from two concurrently operating technologies to three, and the compatibility considerations in a broadcast network medium extend not only to intended receivers but to any receiver. **Table 3-4** describes the compatibility between transmitters of frames and their intended receivers. That is, if a transmitter of the type in the left column sends a frame directed to a receiver of the type in any of the other three columns, what will the result be? One of the major methods used to support coexistence is backward compatibility. When built, 802.11ac devices will also incorporate 802.11a and 802.11n data rates, and thus will be able to send to older peers at older data rates.

(Source: 802.11ac: A Survival Guide: Wi-Fi at Gigabit and Beyond, Gast, Matthew S.)

Table 3-5. Compatibility between transmitters and listening devices

Transmitter type	802.11a listener	802.11n listener	802.11ac listener
802.11a	Designed operation	802.11n devices listen to 802.11a frames and defer medium access to avoid collisions	802.11ac devices listen to 802.11a frames and defer medium access to avoid collisions
802.11n	802.11n greenfield frames require RTS/CTS or CTS-to-self protection; 802.11n mixed-mode frames require no special protection	Designed operation	802.11ac devices listen to 802.11n frames and defer medium access to avoid collisions
802.11ac	802.11ac uses a compatible physical preamble, allowing 802.11a devices to read the medium as busy and avoid collisions	802.11ac uses a compatible preamble, allowing 802.11n devices to read the medium as busy and avoid collisions	Designed operation

(Source: 802.11ac: A Survival Guide: Wi-Fi at Gigabit and Beyond, Gast, Matthew S.)

20.3.3 Transmitter block diagram

HT-mixed format and HT-greenfield format transmissions can be generated using a transmitter consisting of the following blocks:

- a) *Scrambler* scrambles the data to reduce the probability of long sequences of zeros or ones; see 20.3.11.2.
- b) *Encoder parser*, if BCC encoding is to be used, demultiplexes the scrambled bits among N_{ES} (number of BCC encoders for the Data field) BCC encoders, in a round robin manner.
- c) *FEC encoders* encode the data to enable error correction. An FEC encoder may include a binary convolutional encoder followed by a puncturing device, or it may include an LDPC encoder.
- d) *Stream parser* divides the outputs of the encoders into blocks that are sent to different interleaver and mapping devices. The sequence of the bits sent to an interleaver is called a *spatial stream*.
- e) *Interleaver* interleaves the bits of each spatial stream (changes order of bits) to prevent long sequences of adjacent noisy bits from entering the BCC decoder. Interleaving is applied only when BCC encoding is used.
- f) *Constellation mapper* maps the sequence of bits in each spatial stream to constellation points (complex numbers).
- g) *STBC* encoder spreads constellation points from N_{SS} spatial streams into N_{STS} space-time streams using a space-time block code. STBC is used only when $N_{SS} < N_{STS}$; see 20.3.11.8.1.
- h) *Spatial mapper* maps space-time streams to transmit chains. This may include one of the following:
 - 1) *Direct mapping*: Constellation points from each space-time stream are mapped directly onto the transmit chains (one-to-one mapping).

(Source: <https://web.archive.org/web/20190220214328/http://luci.subsignal.org/~jow/802.11n-2009.pdf>)

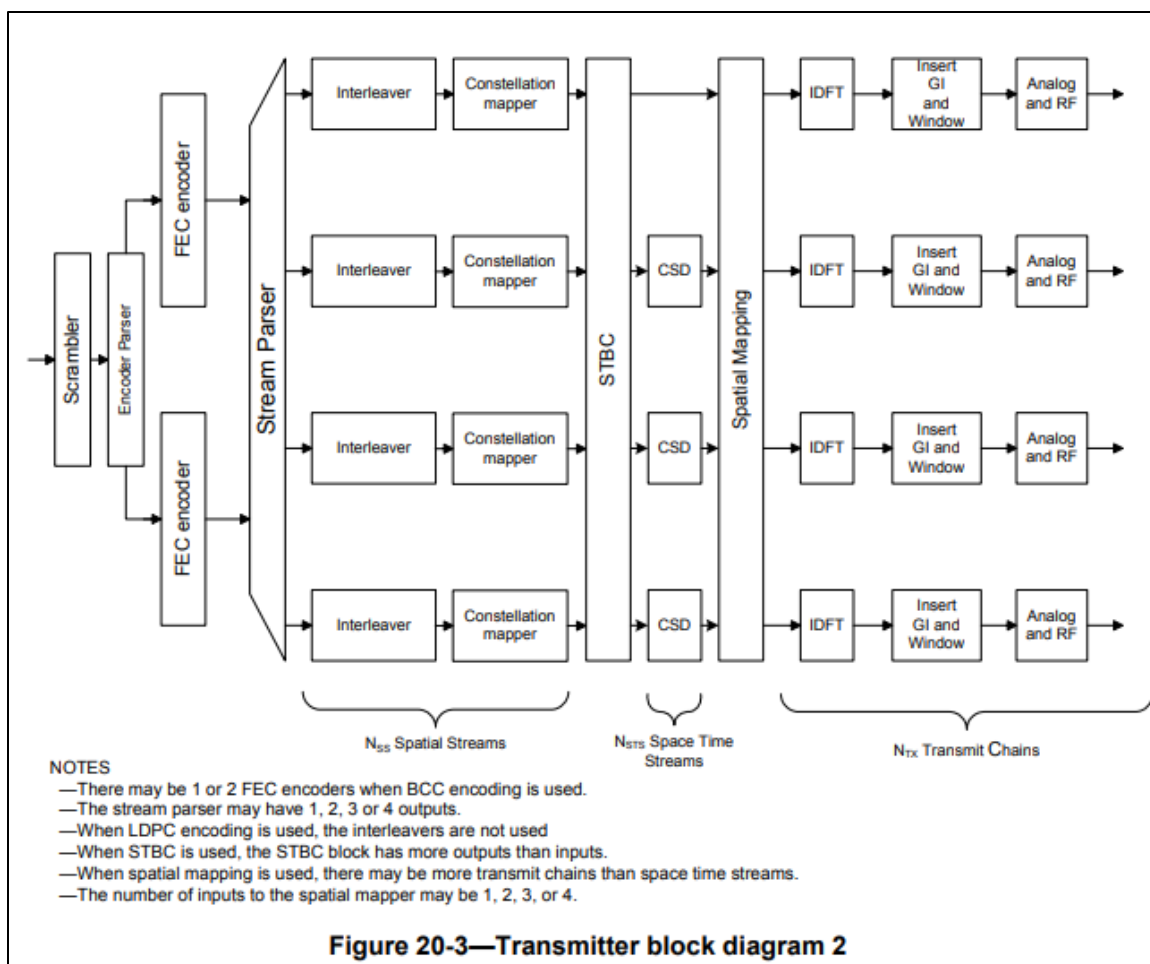

(Source: <https://web.archive.org/web/20190220214328/http://luci.subsignal.org/~jow/802.11n-2009.pdf>)

39. The accused products include one or more OFDM modulators, each OFDM modulator connected to a respective TDB, each OFDM modulator configured to produce a frame including a plurality of data symbols, a training structure, and cyclic prefixes inserted among the data symbols. For example, according to the IEEE 802.11n standard, a transmitter block would contain different functional blocks which include constellation mappers, IDFT stage, and Guard interval insertion. The constellation mapper maps the bits and the constellation points for different modulation schemes like QPSK, BPSK, 16-QAM, and 64-QAM. Hence, there would be modulator blocks for performing the modulation. After modulating the signal, it is converted

into the time domain and is transmitted as frames of data. These transmitted frames include a training structure, signal bits, cyclic prefixes and data bits.

20.3.3 Transmitter block diagram

HT-mixed format and HT-greenfield format transmissions can be generated using a transmitter consisting of the following blocks:

- a) *Scrambler* scrambles the data to reduce the probability of long sequences of zeros or ones; see 20.3.11.2.
- b) *Encoder parser*, if BCC encoding is to be used, demultiplexes the scrambled bits among N_{ES} (number of BCC encoders for the Data field) BCC encoders, in a round robin manner.
- c) *FEC encoders* encode the data to enable error correction. An FEC encoder may include a binary convolutional encoder followed by a puncturing device, or it may include an LDPC encoder.
- d) *Stream parser* divides the outputs of the encoders into blocks that are sent to different interleaver and mapping devices. The sequence of the bits sent to an interleaver is called a *spatial stream*.
- e) *Interleaver* interleaves the bits of each spatial stream (changes order of bits) to prevent long sequences of adjacent noisy bits from entering the BCC decoder. Interleaving is applied only when BCC encoding is used.
- f) *Constellation mapper* maps the sequence of bits in each spatial stream to constellation points (complex numbers).
- g) *STBC encoder* spreads constellation points from N_{SS} spatial streams into N_{STS} space-time streams using a space-time block code. STBC is used only when $N_{SS} < N_{STS}$; see 20.3.11.8.1.
- h) *Spatial mapper* maps space-time streams to transmit chains. This may include one of the following:
 - 1) *Direct mapping*: Constellation points from each space-time stream are mapped directly onto the transmit chains (one-to-one mapping).

(Source: <https://web.archive.org/web/20190220214328/http://luci.subsignal.org/~jow/802.11n-2009.pdf>)

The encoding process is composed of the steps described below. The following overview is intended to facilitate an understanding of the details of the convergence procedure:

- a) Determine the number of transmit chains, N_{TX} , from the N_TX field of the TXVECTOR. Produce the PLCP preamble training fields for each of the N_{TX} transmit chains based on the FORMAT, NUM_EXTEN_SS, CH_BANDWIDTH, and MCS parameters of the TXVECTOR. The format and relative placement of the PLCP preamble training fields vary depending on the frame format being used, as indicated by these parameters. Apply cyclic shifts. Determine spatial mapping to be used for HT-STF and HT-LTFs in HT-mixed format frame and HT-GF-STF and HT-LTFs in HT-greenfield format frame from the EXPANSION_MAT parameter of the TXVECTOR. Refer to 20.3.9 for details.
- b) Construct the PLCP preamble SIGNAL fields from the appropriate fields of the TXVECTOR by adding tail bits, applying convolutional coding, formatting into one or more OFDM symbols, applying cyclic shifts, applying spatial processing, calculating an inverse Fourier transform for each OFDM symbol and transmit chain, and prepending a cyclic prefix or GI to each OFDM symbol in each transmit chain. The number and placement of the PLCP preamble SIGNAL fields depend on the frame format being used. Refer to 20.3.9.3.5, 20.3.9.4.3, and 20.3.9.5.3.
- c) Concatenate the PLCP preamble training and SIGNAL fields for each transmit chain one field after another, in the appropriate order, as described in 20.3.2 and 20.3.7.

(Source: <https://web.archive.org/web/20190220214328/http://luci.subsignal.org/~jow/802.11n-2009.pdf>)

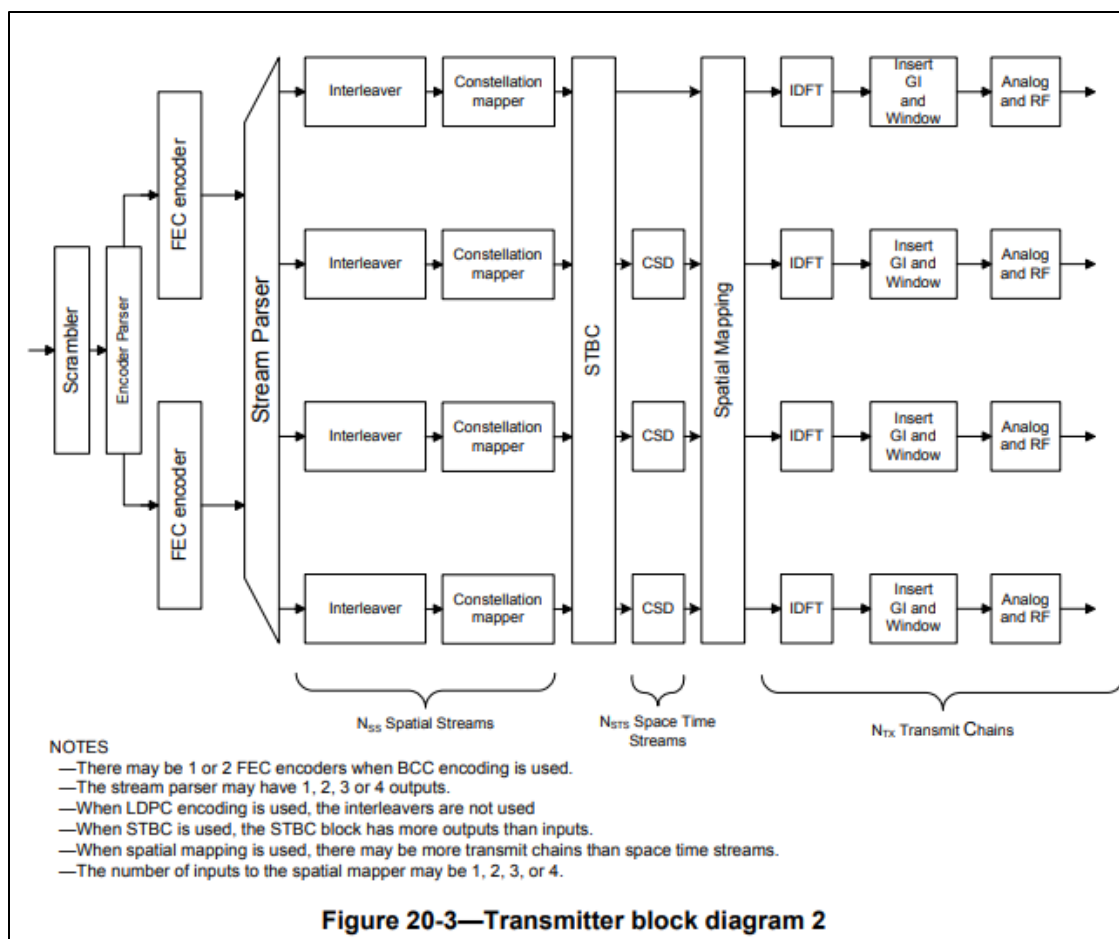

(Source: <https://web.archive.org/web/20190220214328/http://luci.subsignal.org/~jow/802.11n-2009.pdf>)

40. The accused products include one or more transmitting antennas in communication with the one or more OFDM modulators, respectively, each transmitting antenna configured to transmit the respective frame over a channel. The accused products support 802.11 a/b/g/n/ac WiFi standards and comprise one or more transmitting and one or more receiving antennas. These transmitting antennas transmit multiple OFDM frames with various signal fields over a channel. Thus, these transmitting antennas are connected to the OFDM modulators to obtain the OFDM frames for further transmission.

Connectivity	2.4 GHz Spectrum Capabilities
	5 GHz Spectrum Capabilities
	6 GHz Spectrum Capabilities
	Wi-Fi CERTIFIED 6™
	Wi-Fi CERTIFIED™ a
	Wi-Fi CERTIFIED™ ac
	Wi-Fi CERTIFIED™ b
	Wi-Fi CERTIFIED™ g
Wi-Fi CERTIFIED™ n	
Wi-Fi Enhanced Open™ 2021-01	

(Source : <https://api.cert.wi-fi.org/api/certificate/download/public?variantId=109842>)

Connectivity	2.4 GHz Spectrum Capabilities
	5 GHz Spectrum Capabilities
	6 GHz Spectrum Capabilities
	Wi-Fi CERTIFIED 6™
	Wi-Fi CERTIFIED™ a
	Wi-Fi CERTIFIED™ ac
	Wi-Fi CERTIFIED™ b
	Wi-Fi CERTIFIED™ g
Wi-Fi CERTIFIED™ n	
Wi-Fi Enhanced Open™ 2021-01	

(Source : <https://api.cert.wi-fi.org/api/certificate/download/public?variantId=109842>)

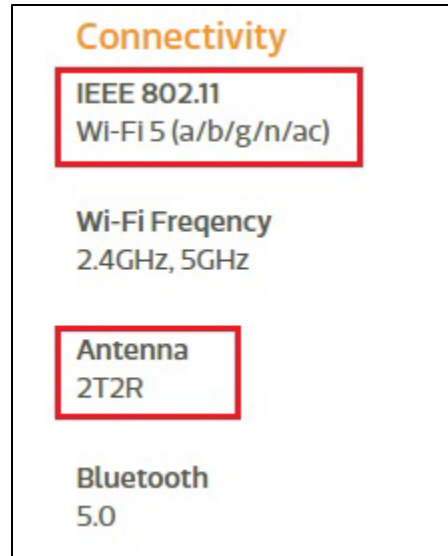

(Source : <https://www.mediatek.com/products/home-networking/mt8167s>)

Connectivity

Cellular Technologies
 2G-5G Multi-Mode, 5G/4G CA, 5G/4G FDD / TDD, CDMA2000 1x/EVDO Rev. A (SRLTE), EDGE, GSM, TD-SCDMA, WCDMA

Specific Functions
 5G/4G Dual SIM Dual Active, SA & NSA modes; SA Option2, NSA Option3 / 3a / 3x, NR TDD and FDD bands, DSS, NR DL 3CC, 300MHz bandwidth, 4x4 MIMO, 256QAM NR UL 2CC, R16 UL Enhancement, 2x2 MIMO, 256QAM VoNR / EPS fallback

Peak Download / Upload Speed
 7Gbps / 2.5Gbps

GNSS
 GPS L1CA+L5 / BeiDou B1I+ B2a + B1C / Glonass L10F / Galileo E1 + E5a / QZSS L1CA+ L5 / NavIC

Wi-Fi
 Wi-Fi 6E (a/b/g/n/ac/ax)

Wi-Fi Antenna
 2T2R

Bluetooth
 5.3

(Source : <https://www.mediatek.com/products/smartphones-2/mediatek-dimension-9000>)

The 802.11n-2009 wireless LAN standard provides Higher Throughput (HT) rates. These higher rates are achieved by a combination of MAC and PHY layer enhancements. The enhancements include:

- Reducing the per-packet overhead in the MAC layer.
- Allowing multiple MAC packets to be combined into a single PHY-layer burst.
- Allowing (optionally) a more efficient LDPC encoder.
- Allowing (optionally) a shorter guard interval (cyclic prefix) on the data symbols.
- Increasing the number of subcarriers used in the default 20 MHz physical channel.
- Providing an (optional) 40 MHz mode.
- Using MIMO techniques to broadcast multiple data streams over a single frequency channel.

By combining these techniques, the goal is to increase the usable data transfer rate by a factor of 10.

Signal Characteristics

The 802.11n standard uses OFDM modulation to transmit all data. It defines three operating modes:

(Source: http://rfmw.em.keysight.com/wireless/helpfiles/89600b/webhelp/subsystems/wlan-mimo/Content/mimo_80211n_overview.htm)

20.3.4 Overview of the PPDU encoding process

The encoding process is composed of the steps described below. The following overview is intended to facilitate an understanding of the details of the convergence procedure:

- a) Determine the number of transmit chains, N_{TX} , from the N_TX field of the TXVECTOR. Produce the PLCP preamble training fields for each of the N_{TX} transmit chains based on the FORMAT, NUM_EXTEN_SS, CH_BANDWIDTH, and MCS parameters of the TXVECTOR. The format and relative placement of the PLCP preamble training fields vary depending on the frame format being used, as indicated by these parameters. Apply cyclic shifts. Determine spatial mapping to be used for HT-STF and HT-LTFs in HT-mixed format frame and HT-GF-STF and HT-LTFs in HT-greenfield format frame from the EXPANSION_MAT parameter of the TXVECTOR. Refer to 20.3.9 for details.
- b) Construct the PLCP preamble SIGNAL fields from the appropriate fields of the TXVECTOR by adding tail bits, applying convolutional coding, formatting into one or more OFDM symbols, applying cyclic shifts, applying spatial processing, calculating an inverse Fourier transform for each OFDM symbol and transmit chain, and prepending a cyclic prefix or GI to each OFDM symbol in each transmit chain. The number and placement of the PLCP preamble SIGNAL fields depend on the frame format being used. Refer to 20.3.9.3.5, 20.3.9.4.3, and 20.3.9.5.3.
- c) Concatenate the PLCP preamble training and SIGNAL fields for each transmit chain one field after another, in the appropriate order, as described in 20.3.2 and 20.3.7.

(Source: <https://web.archive.org/web/20190220214328/http://luci.subsignal.org/~jow/802.11n-2009.pdf>)

41. The accused products include wherein the training structure of each frame includes a predetermined signal transmission matrix at a respective sub-channel, each training structure adjusted to have a substantially constant amplitude in a time domain, and the cyclic prefixes are further inserted within the training symbol, and wherein the cyclic prefixes within the training symbol are longer than the cyclic prefixes among the data symbols, thereby countering an extended channel impulse response and improving synchronization performance. For example, a space time matrix is part of the data symbols and the training symbols in the transmission data. This data is transmitted over different antennas. The WiFi standards use

guard intervals while transmitting frames to help the synchronization of frames at the receiver end. These guard intervals are of different lengths for the preamble and data symbols. The screenshots below show the Guard interval in the Long Training Field is 1.6 micro seconds, and the data field uses a Short guard interval of 0.4 micro seconds, so the cyclic prefix for the training symbols is longer than the cyclic prefix for data symbols. The training symbols (L-STF, HT-STF fields) in the 802.11n preamble have a constant amplitude in the time domain.

- p) Map each of the complex numbers in each of the N_{ST} subcarriers in each of the OFDM symbols in each of the N_{STS} space-time streams to the N_{TX} transmit chain inputs. For direct-mapped operation, $N_{TX} = N_{STS}$, and there is a one-to-one correspondence between space-time streams and transmit chains. In this case, the OFDM symbols associated with each space-time stream are also associated with the corresponding transmit chain. Otherwise, a spatial mapping matrix associated with each OFDM subcarrier, as indicated by the EXPANSION_MAT parameter of the TXVECTOR, is used to perform a linear transformation on the vector of N_{STS} complex numbers associated with each subcarrier in each OFDM symbol. This spatial mapping matrix maps the vector of N_{STS} complex numbers in each subcarrier into a vector of N_{TX} complex numbers in each subcarrier. The sequence of N_{ST} complex numbers associated with each transmit chain (where each of the N_{ST} complex numbers is taken from the same position in the N_{TX} vector of complex numbers across the N_{ST} subcarriers associated with an OFDM symbol) constitutes an OFDM symbol associated with the corresponding transmit chain. For details, see 20.3.11.10. Spatial mapping matrices may include cyclic shifts, as described in 20.3.11.10.1.

(Source: <https://web.archive.org/web/20190220214328/http://luci.subsignal.org/~jow/802.11n-2009.pdf>)

T_{DFT} : IDFT/DFT period	3.2 μ s	3.2 μ s	3.2 μ s
T_{GI} : Guard interval duration	0.8 μ s = $T_{DFT}/4$	0.8 μ s	0.8 μ s
T_{GI2} : Double guard interval	1.6 μ s	1.6 μ s	1.6 μ s
T_{GIS} : Short guard interval duration	N/A	0.4 μ s = $T_{DFT}/8$	0.4 μ s See NOTE 2
T_{L-STF} : Non-HT short training sequence duration	8 μ s = $10 \times T_{DFT}/4$	8 μ s	8 μ s
$T_{HT-GF-STF}$: HT-greenfield short training field duration	N/A	8 μ s = $10 \times T_{DFT}/4$	8 μ s See NOTE 2
T_{L-LTF} : Non-HT long training field duration	8 μ s = $2 \times T_{DFT} + T_{GI2}$	8 μ s	8 μ s
T_{SYM} : Symbol interval	4 μ s = $T_{DFT} + T_{GI}$	4 μ s	4 μ s
T_{SYMS} : Short GI symbol interval	N/A	3.6 μ s = $T_{DFT} + T_{GIS}$	3.6 μ s See NOTE 2

(Source: <https://web.archive.org/web/20190220214328/http://luci.subsignal.org/~jow/802.11n-2009.pdf>)

STBC	2	Set to a nonzero number, to indicate the difference between the number of space-time streams (N_{STS}) and the number of spatial streams (N_{SS}) indicated by the MCS. Set to 00 to indicate no STBC ($N_{STS} = N_{SS}$). See NOTE 1.
FEC coding	1	Set to 1 for LDPC. Set to 0 for BCC.
Short GI	1	Set to 1 to indicate that the short GI is used after the HT training. Set to 0 otherwise.

(Source: <https://web.archive.org/web/20190220214328/http://luci.subsignal.org/~jow/802.11n-2009.pdf>)

20.3.11.10.5 Transmission with a short GI

Short GI is used in the data field of the packet when the Short GI field in the HT-SIG is set to 1. When it is used, the same formula for the formation of the signal shall be used as in 20.3.11.10.2, 20.3.11.10.3, and 20.3.11.10.4, with T_{GI} replaced by T_{GIS} and T_{SYM} replaced by T_{SYMS} .

(Source: <https://web.archive.org/web/20190220214328/http://luci.subsignal.org/~jow/802.11n-2009.pdf>)

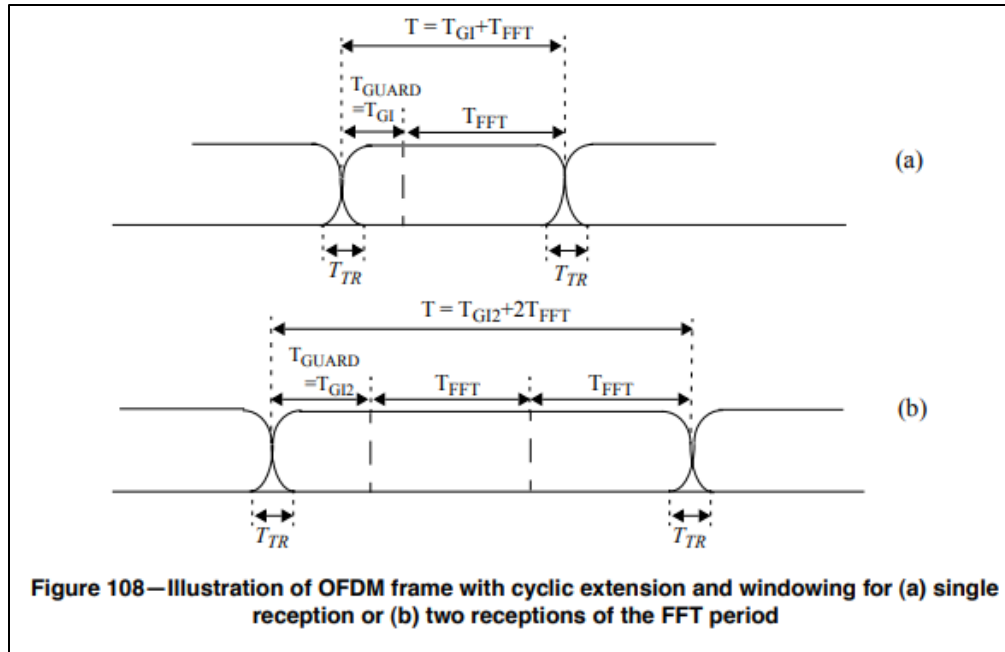

(Source:

<https://web.archive.org/web/20181225052447/http://www.ahltek.com/WhitePaperspdf/802.11-20%20specs/802.11a-1999.pdf>)

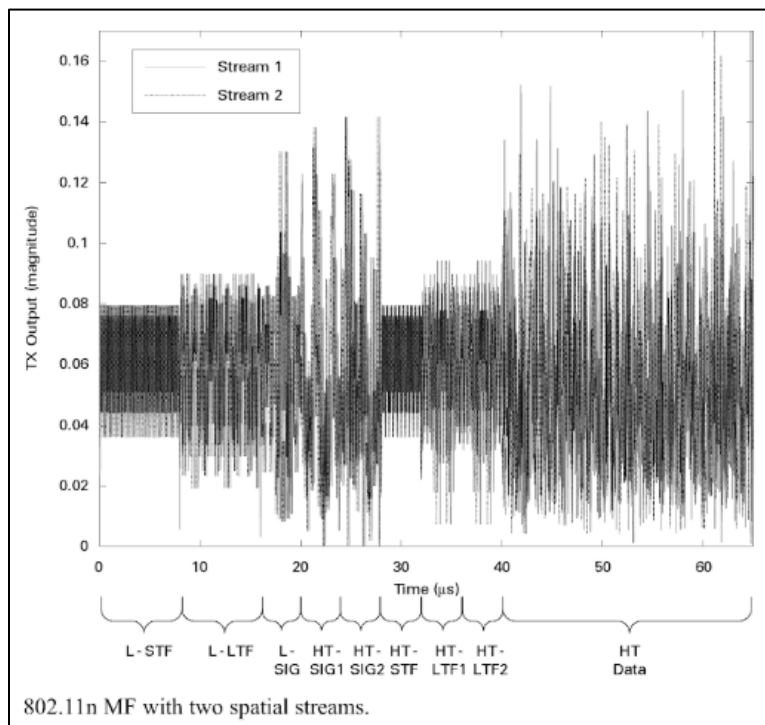

(Source: Next Generation Wireless LANs: 802.11n and 802.11ac, Perahia, Eldad and Stacey, Robert)

42. MediaTek has directly infringed at least through its making and use of the accused products through its own testing of the accused products, and through joint infringement with its affiliates, with its subsidiaries, with carriers, with retailers and other sales entities, with its business partners, with certification organizations, with testing organizations, with other agents of MediaTek, and/or with its customers and end-users, at least making and using the claimed apparatus. Such acts of infringement include directing or controlling other persons to engage in conduct satisfying one or more elements of the asserted claims, deriving a financial or other benefit from doing so. MediaTek's direction or control of its affiliates and end-users includes regularly contracting with those affiliates and end-users. Also, as explained further below, MediaTek took active steps and advised or directed customers and end-users to make and/or use the accused products in an infringing manner.

43. MediaTek has had knowledge of the '304 Patent at least as of December 21, 2007, when the published application of the '304 Patent, U.S. Patent Application Publication No. 2002/0181390, was cited by the examiner during the prosecution of U.S. Patent Application No. 10/301,046. That application issued as U.S. Patent No. 7,394,754, titled "System and Method for Transmitting Data in a Multiple-Branch Transmitter-Diversity Orthogonal Frequency-Division Multiplexing (OFDM) System" and assigned to MediaTek Inc. MediaTek employees Kuo Hui Li, Charles Huang, Mao-Ching Chiu, Hung-Kun Chen, and Chao-Ming Chang, who are listed as inventors on U.S. Patent No. 7,394,754, and others involved in the prosecution of the patent, including Daniel R. McClure and Hui Chin Barnhill, have had knowledge of the '304 Patent at least as of December 21, 2007.

44. MediaTek has had actual knowledge of the ‘304 Patent at least as of the date when it was notified of the filing of this action. By the time of trial, MediaTek will have known and intended (since receiving such notice) that its continued actions would infringe and actively induce and contribute to the infringement of one or more claims of the ‘304 Patent.

45. MediaTek has also indirectly and willfully infringed, and continues to indirectly and willfully infringe, the ‘304 Patent, as explained further below in the “Additional Allegations Regarding Infringement” section.

46. American Patents has been damaged as a result of the infringing conduct by MediaTek alleged above. Thus, MediaTek is liable to American Patents in an amount that adequately compensates it for such infringements, which, by law, cannot be less than a reasonable royalty, together with interest and costs as fixed by this Court under 35 U.S.C. § 284.

47. American Patents has neither made nor sold unmarked articles that practice the ‘304 Patent, and is entitled to collect pre-filing damages for the full period allowed by law for infringement of the ‘304 Patent.

COUNT III

INFRINGEMENT OF U.S. PATENT NO. 7,706,458

48. On April 27, 2010, United States Patent No. 7,706,458 (“the ‘458 Patent”) was duly and legally issued by the United States Patent and Trademark Office for an invention entitled “Time And Frequency Synchronization In Multi-Input, Multi-Output (MIMO) Systems.”

49. American Patents is the owner of the ‘458 Patent, with all substantive rights in and to that patent, including the sole and exclusive right to prosecute this action and enforce the ‘458 Patent against infringers, and to collect damages for all relevant times.

50. MediaTek made, had made, used, imported, provided, supplied, distributed, sold, and/or offered for sale products and/or systems including, for example, its MediaTek MT7915 Wi-Fi Wave 1+ chipset (with 2x2 MIMO), MediaTek MT8167S Wireless Connected Multimedia Solution (with 2x2 MIMO), and MediaTek Dimensity 9000 chipset (with 2x2 MIMO) families of products that include 802.11n and above capabilities and/or LTE capabilities (“accused products”):



(Source : <https://www.mediatek.com/blog/mediatek-mt7915-wi-fi-6-wave-1-chipset-builds-in-a-range-of-industry-firsts>)



(Source : <https://www.mediatek.com/products/home-networking/mt8167s>)



Products Technology Investors About

MediaTek Dimensity 9000

Rise to Incredible new heights with flagship smartphones you've always envisioned

(Source : <https://www.mediatek.com/products/smartphones-2/mediatek-dimensity-9000>)



Wi-Fi CERTIFIED™ Certificate



This certificate lists the features that have successfully completed Wi-Fi Alliance interoperability testing. Learn more: www.wi-fi.org/certification/programs

Certification ID: WFA93165

Product Info	
Date of Certification	December 1, 2021
Company	MediaTek Inc.
Product Name	MT7915
Product Model Variant	QoS update
Model Number	MT7915
Category	Other
Sub-category	Embedded Module

(Source : <https://api.cert.wi-fi.org/api/certificate/download/public?variantId=109842>)

Connectivity	2.4 GHz Spectrum Capabilities
	5 GHz Spectrum Capabilities
	6 GHz Spectrum Capabilities
	Wi-Fi CERTIFIED 6™
	Wi-Fi CERTIFIED™ a
	Wi-Fi CERTIFIED™ ac
	Wi-Fi CERTIFIED™ b
	Wi-Fi CERTIFIED™ g
Wi-Fi CERTIFIED™ n	
Wi-Fi Enhanced Open™ 2021-01	

(Source : <https://api.cert.wi-fi.org/api/certificate/download/public?variantId=109842>)

Connectivity	2.4 GHz Spectrum Capabilities
	5 GHz Spectrum Capabilities
	6 GHz Spectrum Capabilities
	Wi-Fi CERTIFIED 6™
	Wi-Fi CERTIFIED™ a
	Wi-Fi CERTIFIED™ ac
	Wi-Fi CERTIFIED™ b
	Wi-Fi CERTIFIED™ g
Wi-Fi CERTIFIED™ n	
Wi-Fi Enhanced Open™ 2021-01	

(Source : <https://api.cert.wi-fi.org/api/certificate/download/public?variantId=109842>)

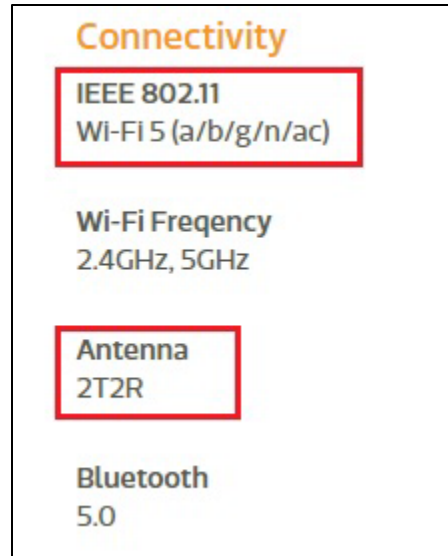

(Source : <https://www.mediatek.com/products/home-networking/mt8167s>)

Connectivity

Cellular Technologies
2G-5G Multi-Mode, 5G/4G CA, 5G/4G FDD / TDD, CDMA2000 1x/EVDO Rev. A (SRLTE), EDGE, GSM, TD-SCDMA, WCDMA

Specific Functions
5G/4G Dual SIM Dual Active, SA & NSA modes; SA Option2, NSA Option3 / 3a / 3x, NR TDD and FDD bands, DSS, NR DL 3CC, 300MHz bandwidth, 4x4 MIMO, 256QAM NR UL 2CC, R16 UL Enhancement, 2x2 MIMO, 256QAM VoNR / EPS fallback

Peak Download / Upload Speed
7Gbps / 2.5Gbps

GNSS
GPS L1CA+L5 / BeiDou B1I+ B2a + B1C / Glonass L10F / Galileo E1 + E5a / QZSS L1CA+ L5 / NavIC

Wi-Fi
Wi-Fi 6E (a/b/g/n/ac/ax)

Wi-Fi Antenna
2T2R

Bluetooth
5.3

(Source : <https://www.mediatek.com/products/smartphones-2/mediatek-dimension-9000>)

51. By doing so, MediaTek has directly infringed (literally and/or under the doctrine of equivalents) at least Claim 1 of the '458 Patent. MediaTek's infringement in this regard is ongoing.

52. MediaTek has infringed the '458 Patent by making, having made, using, importing, providing, supplying, distributing, selling or offering for sale products including an apparatus for synchronizing a communication system. For example, the accused products can act and have acted as a receiver in an apparatus for synchronizing a communication system. An

802.11 n/ac compliant WiFi access point that is communicating with an accused product can be part of the apparatus, acting as a transmitter. The accused products support IEEE 802.11 n/ac standards and MIMO technology. The IEEE 802.11ac standard is backwards compatible with the 802.11n standard. If a device such as an accused product complies with IEEE 802.11ac, it also complies with IEEE 802.11n and all prior versions of the WiFi standards (802.11 a/b/g/n). According to the 802.11a standard, the physical layer services include an OFDM system. According to the IEEE 802.11n standard, all Protocol Data Unit (PPDU) frame formats have training fields and signaling fields which would help in synchronizing the communication system.

The introduction of 802.11ac expands the compatibility matrix in the 5 GHz band from two concurrently operating technologies to three, and the compatibility considerations in a broadcast network medium extend not only to intended receivers but to any receiver. Table 3-4 describes the compatibility between transmitters of frames and their intended receivers. That is, if a transmitter of the type in the left column sends a frame directed to a receiver of the type in any of the other three columns, what will the result be? One of the major methods used to support coexistence is backward compatibility. When built, 802.11ac devices will also incorporate 802.11a and 802.11n data rates, and thus will be able to send to older peers at older data rates.

(Source: 802.11ac: A Survival Guide: Wi-Fi at Gigabit and Beyond, Gast, Matthew S.)

Table 3-5. Compatibility between transmitters and listening devices

Transmitter type	802.11a listener	802.11n listener	802.11ac listener
802.11a	Designed operation	802.11n devices listen to 802.11a frames and defer medium access to avoid collisions	802.11ac devices listen to 802.11a frames and defer medium access to avoid collisions
802.11n	802.11n greenfield frames require RTS/CTS or CTS-to-self protection; 802.11n mixed-mode frames require no special protection	Designed operation	802.11ac devices listen to 802.11n frames and defer medium access to avoid collisions
802.11ac	802.11ac uses a compatible physical preamble, allowing 802.11a devices to read the medium as busy and avoid collisions	802.11ac uses a compatible preamble, allowing 802.11n devices to read the medium as busy and avoid collisions	Designed operation

(Source: 802.11ac: A Survival Guide: Wi-Fi at Gigabit and Beyond, Gast, Matthew S.)

17.1.1 Scope

This subclause describes the PHY services provided to the IEEE 802.11 wireless LAN MAC by the 5 GHz (bands) OFDM system. The OFDM PHY layer consists of two protocol functions, as follows:

- a) A PHY convergence function, which adapts the capabilities of the physical medium dependent (PMD) system to the PHY service. This function is supported by the physical layer convergence procedure (PLCP), which defines a method of mapping the IEEE 802.11 PHY sublayer service data units (PSDU) into a framing format suitable for sending and receiving user data and management information between two or more stations using the associated PMD system.
- b) A PMD system whose function defines the characteristics and method of transmitting and receiving data through a wireless medium between two or more stations, each using the OFDM system.

(Source: https://standards.ieee.org/standard/802_11a-1999.html)

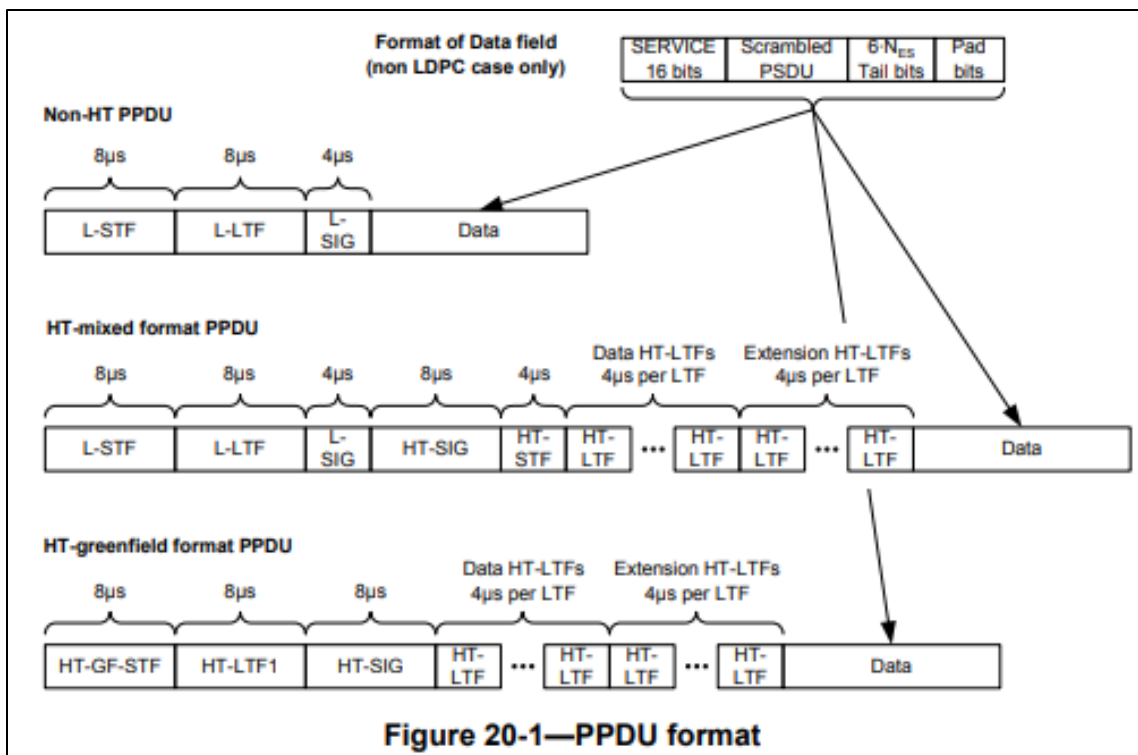

(Source: <https://web.archive.org/web/20190220214328/http://luci.subsignal.org/~jow/802.11n-2009.pdf>)

The fields of the VHT PPDU format are summarized in Table 22-4.

Table 22-4—Fields of the VHT PPDU

Field	Description
L-STF	Non-HT Short Training field
L-LTF	Non-HT Long Training field
L-SIG	Non-HT SIGNAL field
VHT-SIG-A	VHT Signal A field
VHT-STF	VHT Short Training field
VHT-LTF	VHT Long Training field
VHT-SIG-B	VHT Signal B field
Data	The Data field carries the PSDU(s)

(Source: <https://ieeexplore.ieee.org/document/7797535/>)

53. The accused products include a number (Q) of Orthogonal Frequency Division Multiplexing (OFDM) modulators, each OFDM modulator producing a frame having at least one inserted symbol, a plurality of data symbols, and cyclic prefixes. According to the IEEE 802.11n standard, a transmitter block contains different functional blocks which include, but are not limited to, constellation mappers, IDFT stage, and Guard interval insertion. Constellation mappers map the bits and the constellation points for different modulation schemes like QPSK, BPSK, 16-QAM, 64-QAM. After modulating the signal, it is converted into time domain and is transmitted as frames of data. These transmitted frames include training field bits, signal bits, cyclic prefixes and data bits. Alternatively, on request from an accused product, an 802.11 n/ac compliant WiFi access point can act as a transmitter that includes a number (Q) of OFDM modulators, each OFDM modulator producing a frame having at least one inserted symbol, a plurality of data symbols, and cyclic prefixes.

20.3.3 Transmitter block diagram

HT-mixed format and HT-greenfield format transmissions can be generated using a transmitter consisting of the following blocks:

- a) *Scrambler* scrambles the data to reduce the probability of long sequences of zeros or ones; see 20.3.11.2.
- b) *Encoder parser*, if BCC encoding is to be used, demultiplexes the scrambled bits among N_{ES} (number of BCC encoders for the Data field) BCC encoders, in a round robin manner.
- c) *FEC encoders* encode the data to enable error correction. An FEC encoder may include a binary convolutional encoder followed by a puncturing device, or it may include an LDPC encoder.
- d) *Stream parser* divides the outputs of the encoders into blocks that are sent to different interleaver and mapping devices. The sequence of the bits sent to an interleaver is called a *spatial stream*.
- e) *Interleaver* interleaves the bits of each spatial stream (changes order of bits) to prevent long sequences of adjacent noisy bits from entering the BCC decoder. Interleaving is applied only when BCC encoding is used.
- f) *Constellation mapper* maps the sequence of bits in each spatial stream to constellation points (complex numbers).
- g) *STBC encoder* spreads constellation points from N_{SS} spatial streams into N_{STS} space-time streams using a space-time block code. STBC is used only when $N_{SS} < N_{STS}$; see 20.3.11.8.1.
- h) *Spatial mapper* maps space-time streams to transmit chains. This may include one of the following:
 - 1) *Direct mapping*: Constellation points from each space-time stream are mapped directly onto the transmit chains (one-to-one mapping).

(Source: <https://web.archive.org/web/20190220214328/http://luci.subsignal.org/~jow/802.11n-2009.pdf>)

The encoding process is composed of the steps described below. The following overview is intended to facilitate an understanding of the details of the convergence procedure:

- a) Determine the number of transmit chains, N_{TX} , from the N_TX field of the TXVECTOR. Produce the PLCP preamble training fields for each of the N_{TX} transmit chains based on the FORMAT, NUM_EXTEN_SS, CH_BANDWIDTH, and MCS parameters of the TXVECTOR. The format and relative placement of the PLCP preamble training fields vary depending on the frame format being used, as indicated by these parameters. Apply cyclic shifts. Determine spatial mapping to be used for HT-STF and HT-LTFs in HT-mixed format frame and HT-GF-STF and HT-LTFs in HT-greenfield format frame from the EXPANSION_MAT parameter of the TXVECTOR. Refer to 20.3.9 for details.
- b) Construct the PLCP preamble SIGNAL fields from the appropriate fields of the TXVECTOR by adding tail bits, applying convolutional coding, formatting into one or more OFDM symbols, applying cyclic shifts, applying spatial processing, calculating an inverse Fourier transform for each OFDM symbol and transmit chain, and prepending a cyclic prefix or GI to each OFDM symbol in each transmit chain. The number and placement of the PLCP preamble SIGNAL fields depend on the frame format being used. Refer to 20.3.9.3.5, 20.3.9.4.3, and 20.3.9.5.3.
- c) Concatenate the PLCP preamble training and SIGNAL fields for each transmit chain one field after another, in the appropriate order, as described in 20.3.2 and 20.3.7.

(Source: <https://web.archive.org/web/20190220214328/http://luci.subsignal.org/~jow/802.11n-2009.pdf>)

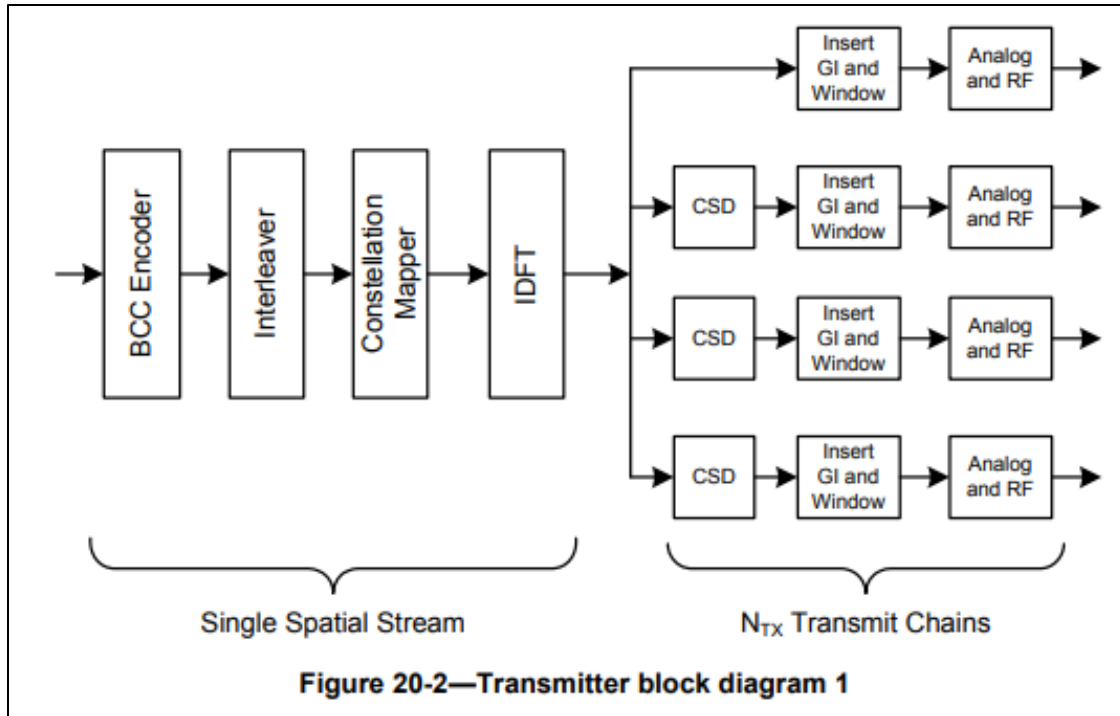

(Source: <https://web.archive.org/web/20190220214328/http://luci.subsignal.org/~jow/802.11n-2009.pdf>)

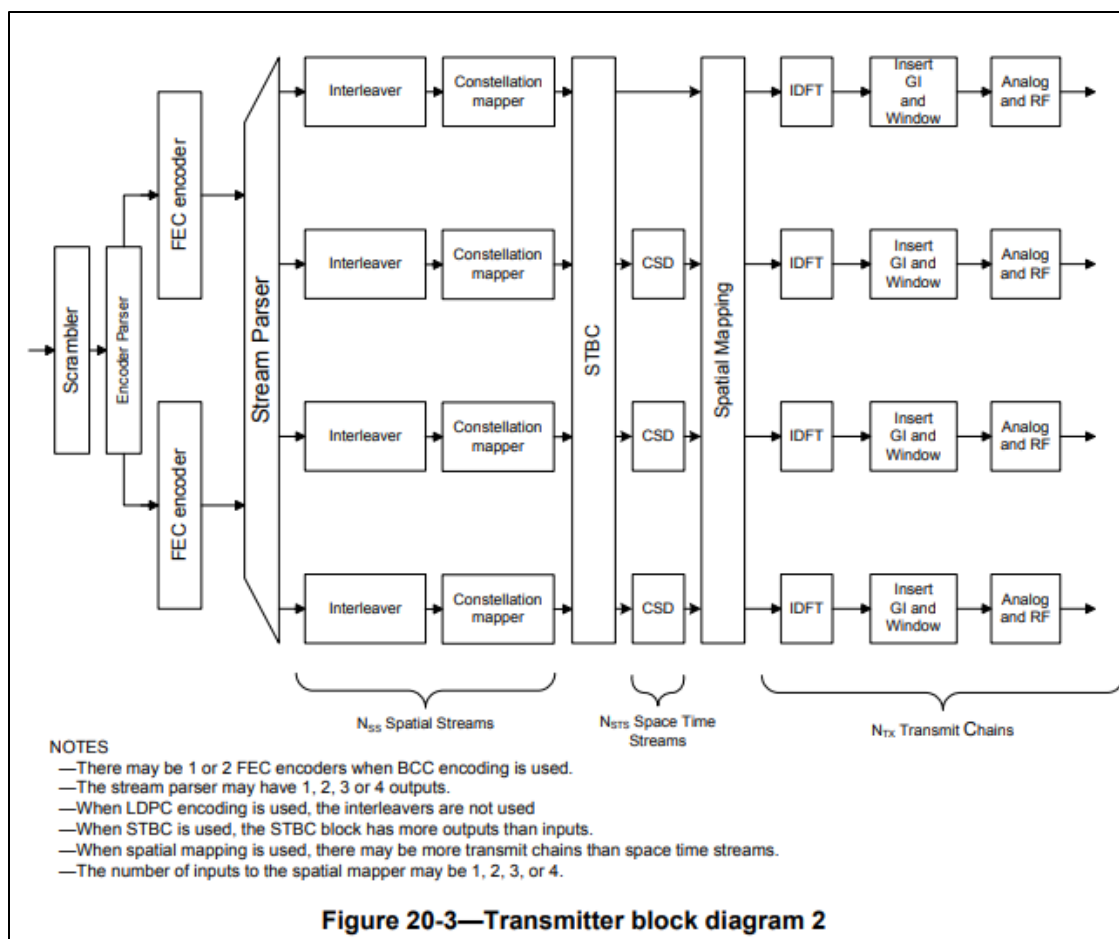

(Source: <https://web.archive.org/web/20190220214328/http://luci.subsignal.org/~jow/802.11n-2009.pdf>)

54. The accused products include Q transmitting antennas, each transmitting antenna connected to a respective OFDM modulator, the transmitting antennas configured to transmit a respective frame over a channel. The accused products support MIMO and comply with IEEE 802.11 a/b/g/n/ac standards. The transmitting antennas transmit multiple OFDM frames over a channel. The transmitting antennas are connected to OFDM modulators to transmit the OFDM frames over a channel. Alternatively, on request from an accused product, a WiFi access point acts as a device that includes Q transmitting antennas, each transmitting antenna connected to a

respective OFDM modulator, the transmitting antennas configured to transmit a respective frame over a channel.

Connectivity	2.4 GHz Spectrum Capabilities
	5 GHz Spectrum Capabilities
	6 GHz Spectrum Capabilities
	Wi-Fi CERTIFIED 6™
	Wi-Fi CERTIFIED™ a
	Wi-Fi CERTIFIED™ ac
	Wi-Fi CERTIFIED™ b
	Wi-Fi CERTIFIED™ g
	Wi-Fi CERTIFIED™ n
	Wi-Fi Enhanced Open™ 2021-01

(Source : <https://api.cert.wi-fi.org/api/certificate/download/public?variantId=109842>)

Connectivity	2.4 GHz Spectrum Capabilities
	5 GHz Spectrum Capabilities
	6 GHz Spectrum Capabilities
	Wi-Fi CERTIFIED 6™
	Wi-Fi CERTIFIED™ a
	Wi-Fi CERTIFIED™ ac
	Wi-Fi CERTIFIED™ b
	Wi-Fi CERTIFIED™ g
	Wi-Fi CERTIFIED™ n
	Wi-Fi Enhanced Open™ 2021-01

(Source : <https://api.cert.wi-fi.org/api/certificate/download/public?variantId=109842>)

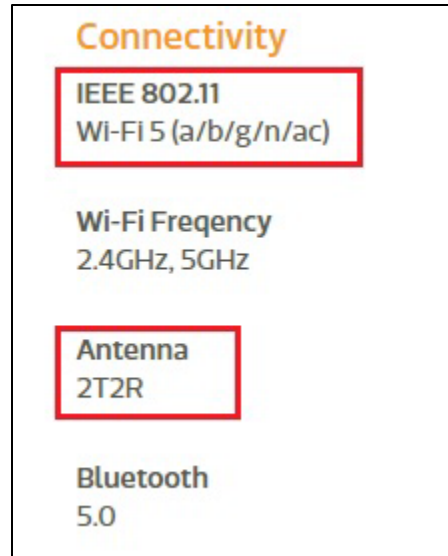

(Source : <https://www.mediatek.com/products/home-networking/mt8167s>)

Connectivity

Cellular Technologies

2G-5G Multi-Mode, 5G/4G CA, 5G/4G FDD / TDD, CDMA2000 1x/EVDO Rev. A (SRLTE), EDGE, GSM, TD-SCDMA, WCDMA

Specific Functions

5G/4G Dual SIM Dual Active, SA & NSA modes; SA Option2, NSA Option3 / 3a / 3x, NR TDD and FDD bands, DSS, NR DL 3CC, 300MHz bandwidth, 4x4 MIMO, 256QAM NR UL 2CC, R16 UL Enhancement, 2x2 MIMO, 256QAM VoNR / EPS fallback

Peak Download / Upload Speed

7Gbps / 2.5Gbps

GNSS

GPS L1CA+L5 / BeiDou B1I+ B2a + B1C / Glonass L10F / Galileo E1 + E5a / QZSS L1CA+ L5 / NavIC

Wi-Fi

Wi-Fi 6E (a/b/g/n/ac/ax)

Wi-Fi Antenna

2T2R

Bluetooth

5.3

(Source : <https://www.mediatek.com/products/smartphones-2/mediatek-dimension-9000>)

20.3.4 Overview of the PPDU encoding process

The encoding process is composed of the steps described below. The following overview is intended to facilitate an understanding of the details of the convergence procedure:

- a) Determine the number of transmit chains, N_{TX} , from the N_TX field of the TXVECTOR. Produce the PLCP preamble training fields for each of the N_{TX} transmit chains based on the FORMAT, NUM_EXTEN_SS, CH_BANDWIDTH, and MCS parameters of the TXVECTOR. The format and relative placement of the PLCP preamble training fields vary depending on the frame format being used, as indicated by these parameters. Apply cyclic shifts. Determine spatial mapping to be used for HT-STF and HT-LTFs in HT-mixed format frame and HT-GF-STF and HT-LTFs in HT-greenfield format frame from the EXPANSION_MAT parameter of the TXVECTOR. Refer to 20.3.9 for details.
- b) Construct the PLCP preamble SIGNAL fields from the appropriate fields of the TXVECTOR by adding tail bits, applying convolutional coding, formatting into one or more OFDM symbols, applying cyclic shifts, applying spatial processing, calculating an inverse Fourier transform for each OFDM symbol and transmit chain, and prepending a cyclic prefix or GI to each OFDM symbol in each transmit chain. The number and placement of the PLCP preamble SIGNAL fields depend on the frame format being used. Refer to 20.3.9.3.5, 20.3.9.4.3, and 20.3.9.5.3.
- c) Concatenate the PLCP preamble training and SIGNAL fields for each transmit chain one field after another, in the appropriate order, as described in 20.3.2 and 20.3.7.

(Source: <https://web.archive.org/web/20190220214328/http://luci.subsignal.org/~jow/802.11n-2009.pdf>)

55. The accused products include a number (L) of receiving antennas for receiving the transmitted frames. For example, the accused products support MIMO and comply with 802.11 a/b/g/n/ac WiFi standards. The receiving antennas receive the transmitted frames.

Connectivity	2.4 GHz Spectrum Capabilities
	5 GHz Spectrum Capabilities
	6 GHz Spectrum Capabilities
	Wi-Fi CERTIFIED 6™
	Wi-Fi CERTIFIED™ a
	Wi-Fi CERTIFIED™ ac
	Wi-Fi CERTIFIED™ b
	Wi-Fi CERTIFIED™ g
Wi-Fi CERTIFIED™ n	
	Wi-Fi Enhanced Open™ 2021-01

(Source : <https://api.cert.wi-fi.org/api/certificate/download/public?variantId=109842>)

Connectivity	2.4 GHz Spectrum Capabilities
	5 GHz Spectrum Capabilities
	6 GHz Spectrum Capabilities
	Wi-Fi CERTIFIED 6™
	Wi-Fi CERTIFIED™ a
	Wi-Fi CERTIFIED™ ac
	Wi-Fi CERTIFIED™ b
	Wi-Fi CERTIFIED™ g
	Wi-Fi CERTIFIED™ n
	Wi-Fi Enhanced Open™ 2021-01

(Source : <https://api.cert.wi-fi.org/api/certificate/download/public?variantId=109842>)

Connectivity
IEEE 802.11 Wi-Fi 5 (a/b/g/n/ac)
Wi-Fi Frequency 2.4GHz, 5GHz
Antenna 2T2R
Bluetooth 5.0

(Source : <https://www.mediatek.com/products/home-networking/mt8167s>)

Connectivity

Cellular Technologies
2G-5G Multi-Mode, 5G/4G CA, 5G/4G FDD / TDD, CDMA2000 1x/EVDO Rev. A (SRLTE), EDGE, GSM, TD-SCDMA, WCDMA

Specific Functions
5G/4G Dual SIM Dual Active, SA & NSA modes; SA Option2, NSA Option3 / 3a / 3x, NR TDD and FDD bands, DSS, NR DL 3CC, 300MHz bandwidth, 4x4 MIMO, 256QAM NR UL 2CC, R16 UL Enhancement, 2x2 MIMO, 256QAM VoNR / EPS fallback

Peak Download / Upload Speed
7Gbps / 2.5Gbps

GNSS
GPS L1CA+L5 / BeiDou B1I+ B2a + B1C / Glonass L10F / Galileo E1 + E5a / QZSS L1CA+ L5 / NavIC

Wi-Fi
Wi-Fi 6E (a/b/g/n/ac/ax)

Wi-Fi Antenna
2T2R

Bluetooth
5.3

(Source : <https://www.mediatek.com/products/smartphones-2/mediatek-dimension-9000>)

56. The accused products include L OFDM demodulators, each OFDM demodulator corresponding to a respective receiving antenna, the L OFDM demodulators including a synchronization circuit that processes the received frame in order to synchronize the received frame in both time domain and frequency domain. For example, there is a demodulator block for performing demodulation on the received frames. Further, synchronizing the received frame in time and frequency domains occurs. In an OFDM transmitter section, a modulated signal is converted into time domain and is transmitted as multiple frames of data. The functional blocks

present at the receiver end processes the received data, converts the data into frequency domain, and performs demodulation. Various signal bits present in the transmitted frames' preamble helps in demodulating the signal. A demodulator block is present at the receiver to perform demodulation. Different fields of data like training bits, cyclic prefixes and other signal bits present in the received frame helps in synchronizing the frame in both time and frequency domain. There is a synchronization circuit which processes the received frame and synchronizes them in both time and frequency domain.

20.3.1 Introduction

A convergence procedure, in which PSDUs are converted to and from PPDU, is provided for the HT PHY in 20.3. During transmission, the PSDU is processed (i.e., scrambled and coded) and appended to the PLCP preamble to create the PPDU. At the receiver, the PLCP preamble is processed to aid in demodulation and delivery of the PSDU.

Two preamble formats are defined. For HT-mixed format operation, the preamble has a non-HT portion and an HT portion. The non-HT portion of the HT-mixed format preamble enables detection of the PPDU and acquisition of carrier frequency and timing by both HT STAs and STAs that are compliant with Clause 17 and/or Clause 19. The non-HT portion of the HT-mixed format preamble also consists of the SIGNAL field defined in Clause 17 and is thus decodable by STAs compliant with Clause 17 and Clause 19 as well as HT STAs.

(Source: <https://web.archive.org/web/20190220214328/http://luci.subsignal.org/~jow/802.11n-2009.pdf>)

3.244 receive chain: The physical entity that implements any necessary signal processing to provide the received signal to the digital baseband. Such signal processing includes filtering, amplification, down-conversion, and sampling.

3.245 sounding: The use of preamble training fields to measure the channel for purposes other than demodulation of the Data portion of the physical layer convergence procedure (PLCP) protocol data unit (PPDU) containing the training fields.

NOTE—These uses include calculation of transmit steering, calculation of recommended MCS, and calculation of calibration parameters.

(Source: <https://web.archive.org/web/20190220214328/http://luci.subsignal.org/~jow/802.11n-2009.pdf>)

The encoding process is composed of the steps described below. The following overview is intended to facilitate an understanding of the details of the convergence procedure:

- a) Determine the number of transmit chains, N_{TX} , from the N_TX field of the TXVECTOR. Produce the PLCP preamble training fields for each of the N_{TX} transmit chains based on the FORMAT, NUM_EXTEN_SS, CH_BANDWIDTH, and MCS parameters of the TXVECTOR. The format and relative placement of the PLCP preamble training fields vary depending on the frame format being used, as indicated by these parameters. Apply cyclic shifts. Determine spatial mapping to be used for HT-STF and HT-LTFs in HT-mixed format frame and HT-GF-STF and HT-LTFs in HT-greenfield format frame from the EXPANSION_MAT parameter of the TXVECTOR. Refer to 20.3.9 for details.
- b) Construct the PLCP preamble SIGNAL fields from the appropriate fields of the TXVECTOR by adding tail bits, applying convolutional coding, formatting into one or more OFDM symbols, applying cyclic shifts, applying spatial processing, calculating an inverse Fourier transform for each OFDM symbol and transmit chain, and prepending a cyclic prefix or GI to each OFDM symbol in each transmit chain. The number and placement of the PLCP preamble SIGNAL fields depend on the frame format being used. Refer to 20.3.9.3.5, 20.3.9.4.3, and 20.3.9.5.3.
- c) Concatenate the PLCP preamble training and SIGNAL fields for each transmit chain one field after another, in the appropriate order, as described in 20.3.2 and 20.3.7.

(Source: <https://web.archive.org/web/20190220214328/http://luci.subsignal.org/~jow/802.11n-2009.pdf>)

20.3.21.7.4 Transmitter modulation accuracy (EVM) test

The transmit modulation accuracy test shall be performed by instrumentation capable of converting the transmitted signals into a streams of complex samples at 40 Msample/s or more, with sufficient accuracy in terms of I/Q arm amplitude and phase balance, dc offsets, phase noise, and analog-to-digital quantization noise. Each transmit chain is connected directly through a cable to the setup input port. A possible embodiment of such a setup is converting the signals to a low intermediate frequency with a microwave synthesizer, sampling the signal with a digital oscilloscope, and decomposing it digitally into quadrature components. The sampled signal shall be processed in a manner similar to an actual receiver, according to the following steps, or an equivalent procedure:

- a) Detect the start of frame.
- b) Detect the transition from short sequences to channel estimation sequences, and establish fine timing (with one sample resolution).
- c) Estimate the coarse and fine frequency offsets.
- d) Derotate the frame according to estimated frequency offset.
- e) Estimate the complex channel response coefficients for each of the subcarriers and each of the transmit chains.
- f) For each of the data OFDM symbols, transform the symbol into subcarrier received values, estimate the phase from the pilot subcarriers in all spatial streams, derotate the subcarrier values according to estimated phase, group the results from all the receiver chains in each subcarrier to a vector, multiply the vector by a zero-forcing equalization matrix generated from the channel estimated during the channel estimation phase.
- g) For each data-carrying subcarrier in each spatial stream, find the closest constellation point and compute the Euclidean distance from it.
- h) Compute the average of the RMS of all errors in a frame. It is given by Equation (20-89).

(Source: <https://web.archive.org/web/20190220214328/http://luci.subsignal.org/~jow/802.11n-2009.pdf>)

57. The accused products include wherein each of the L OFDM demodulators comprises a pre-amplifier, a local oscillator, a mixer having a first input and a second input, the first input connected to an output of the pre-amplifier, the second input connected to an output of the local oscillator, an analog-to-digital converter (ADC) connected to an output of the mixer. The demodulating section at the receiver end includes a pre-amplifier, a local oscillator, a mixer, and an ADC. The received frames undergo filtering, amplification (pre-amplifier), down-conversion and sampling (ADC). There are respective functional blocks for performing these

functions. After transmitting the data, the data is received by a receiving antenna for further processing. To prevent the demodulator from demodulating the noise associated with the received signal, an RF front end circuit is implemented to increase the SNR of the demodulated signal. The RF front end circuit generally consists of amplifiers, local oscillator, filters and mixers. The output from the mixer is generally fed to an analog-to-digital converter (ADC). This RF front end circuit generally lies at the start of the demodulation process.

3.244 receive chain: The physical entity that implements any necessary signal processing to provide the received signal to the digital baseband. Such signal processing includes filtering, amplification, down-conversion, and sampling.

3.245 sounding: The use of preamble training fields to measure the channel for purposes other than demodulation of the Data portion of the physical layer convergence procedure (PLCP) protocol data unit (PPDU) containing the training fields.

NOTE—These uses include calculation of transmit steering, calculation of recommended MCS, and calculation of calibration parameters.

(Source: <https://web.archive.org/web/20190220214328/http://luci.subsignal.org/~jow/802.11n-2009.pdf>)

The technique to combat a low $\text{SNR}_{\text{demod_in}}$ is by adding a front end block, which processes (conditions) the received signal/AWGN/interference before admitting it to the demodulator. This processing can be done in several ways:

(Source: VLSI for Wireless Communication)

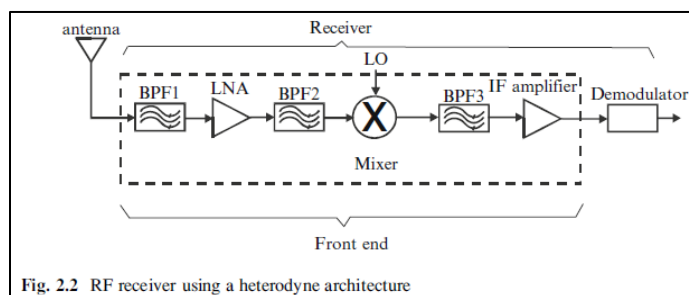

(Source: VLSI for Wireless Communication)

2.4 Rest of Receiver Front End: Nonidealities and Design Parameters

Now that we have talked about the design of filters in the receiver front, we turn our attention to the design of the rest of the components. Normally these components consist of circuits such as LNA, mixer, IF amplifier, and analog/digital (A/D) converter. Unlike filters, their relevant design parameters are different. Hence our first task is to discuss these design parameters.

(Source: VLSI for Wireless Communication)

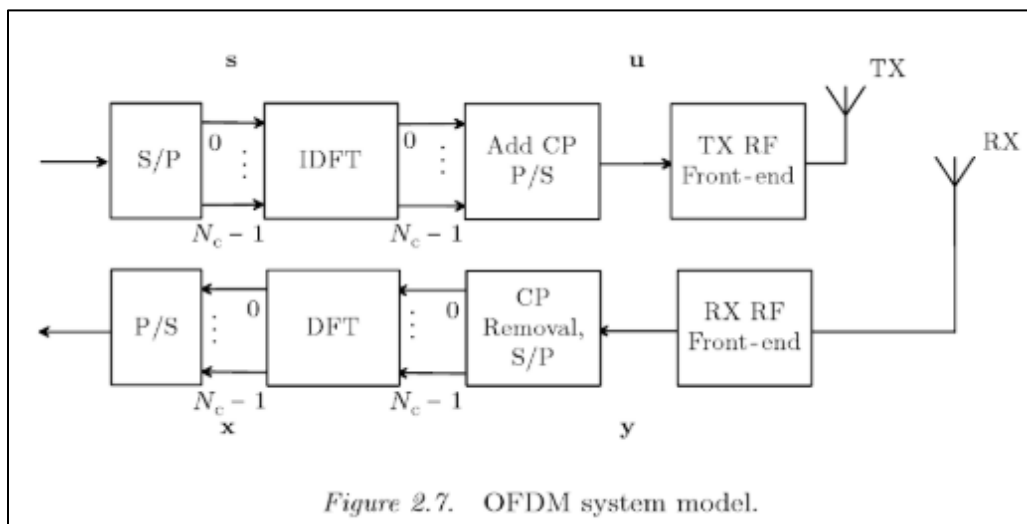

(Source: RF Imperfections in High-rate Wireless Systems: Impact and Digital Compression, Schenk, Tim)

The RF front end is generally defined as everything between the antenna and the digital baseband system. For a receiver, this "between" area includes all the filters, low-noise amplifiers (LNAs), and down-conversion mixer(s) needed to process the modulated signals received at the antenna into signals suitable for input into the baseband analog-to-digital converter (ADC). For this reason, the RF front end is often called the analog-to-digital or RF-to-baseband portion of a receiver.

(Source: https://www.eetimes.com/document.asp?doc_id=1276331)

58. The accused products include the synchronization circuit having one input connected to an output of the ADC. The PPDU frames that are transmitted are demodulated at the receiver end. The demodulation process includes estimating time and frequency offsets and synchronizing accordingly.

20.3.21.7.4 Transmitter modulation accuracy (EVM) test

The transmit modulation accuracy test shall be performed by instrumentation capable of converting the transmitted signals into a streams of complex samples at 40 Msample/s or more, with sufficient accuracy in terms of I/Q arm amplitude and phase balance, dc offsets, phase noise, and analog-to-digital quantization noise. Each transmit chain is connected directly through a cable to the setup input port. A possible embodiment of such a setup is converting the signals to a low intermediate frequency with a microwave synthesizer, sampling the signal with a digital oscilloscope, and decomposing it digitally into quadrature components. The sampled signal shall be processed in a manner similar to an actual receiver, according to the following steps, or an equivalent procedure:

- a) Detect the start of frame.
- b) Detect the transition from short sequences to channel estimation sequences, and establish fine timing (with one sample resolution).
- c) Estimate the coarse and fine frequency offsets.
- d) Derotate the frame according to estimated frequency offset.
- e) Estimate the complex channel response coefficients for each of the subcarriers and each of the transmit chains.
- f) For each of the data OFDM symbols, transform the symbol into subcarrier received values, estimate the phase from the pilot subcarriers in all spatial streams, derotate the subcarrier values according to estimated phase, group the results from all the receiver chains in each subcarrier to a vector, multiply the vector by a zero-forcing equalization matrix generated from the channel estimated during the channel estimation phase.
- g) For each data-carrying subcarrier in each spatial stream, find the closest constellation point and compute the Euclidean distance from it.
- h) Compute the average of the RMS of all errors in a frame. It is given by Equation (20-89).

(Source: <https://web.archive.org/web/20190220214328/http://luci.subsignal.org/~jow/802.11n-2009.pdf>)

The RF front end is generally defined as everything between the antenna and the digital baseband system. For a receiver, this "between" area includes all the filters, low-noise amplifiers (LNAs), and down-conversion mixer(s) needed to process the modulated signals received at the antenna into signals suitable for input into the baseband analog-to-digital converter (ADC). For this reason, the RF front end is often called the analog-to-digital or RF-to-baseband portion of a receiver.

(Source: https://www.eetimes.com/document.asp?doc_id=1276331)

59. The accused products include a cyclic-prefix remover connected to an output of the synchronization circuit, a serial-to-parallel converter connected to an output of the cyclic prefix remover, and a discrete Fournier transform (DFT) stage connected to an output of the serial-to-parallel converter, an output of the DFT stage connected to another input to the synchronization circuit. Cyclic prefixes are added in the preamble for each transmitted frame. In a general OFDM system, a cyclic prefix remover circuit would be present at the receiver end. The output from the cyclic prefix remover circuit would be fed to a serial-to-parallel converter for performing a DFT operation on its output. The evidence also shows that the output of the DFT stage is connected to the phase correction block that is part of the synchronization circuit.

The encoding process is composed of the steps described below. The following overview is intended to facilitate an understanding of the details of the convergence procedure:

- a) Determine the number of transmit chains, N_{TX} , from the N_TX field of the TXVECTOR. Produce the PLCP preamble training fields for each of the N_{TX} transmit chains based on the FORMAT, NUM_EXTEN_SS, CH_BANDWIDTH, and MCS parameters of the TXVECTOR. The format and relative placement of the PLCP preamble training fields vary depending on the frame format being used, as indicated by these parameters. Apply cyclic shifts. Determine spatial mapping to be used for HT-STF and HT-LTFs in HT-mixed format frame and HT-GF-STF and HT-LTFs in HT-greenfield format frame from the EXPANSION_MAT parameter of the TXVECTOR. Refer to 20.3.9 for details.
- b) Construct the PLCP preamble SIGNAL fields from the appropriate fields of the TXVECTOR by adding tail bits, applying convolutional coding, formatting into one or more OFDM symbols, applying cyclic shifts, applying spatial processing, calculating an inverse Fourier transform for each OFDM symbol and transmit chain, and prepending a cyclic prefix or GI to each OFDM symbol in each transmit chain. The number and placement of the PLCP preamble SIGNAL fields depend on the frame format being used. Refer to 20.3.9.3.5, 20.3.9.4.3, and 20.3.9.5.3.
- c) Concatenate the PLCP preamble training and SIGNAL fields for each transmit chain one field after another, in the appropriate order, as described in 20.3.2 and 20.3.7.

(Source: <https://web.archive.org/web/20190220214328/http://luci.subsignal.org/~jow/802.11n-2009.pdf>)

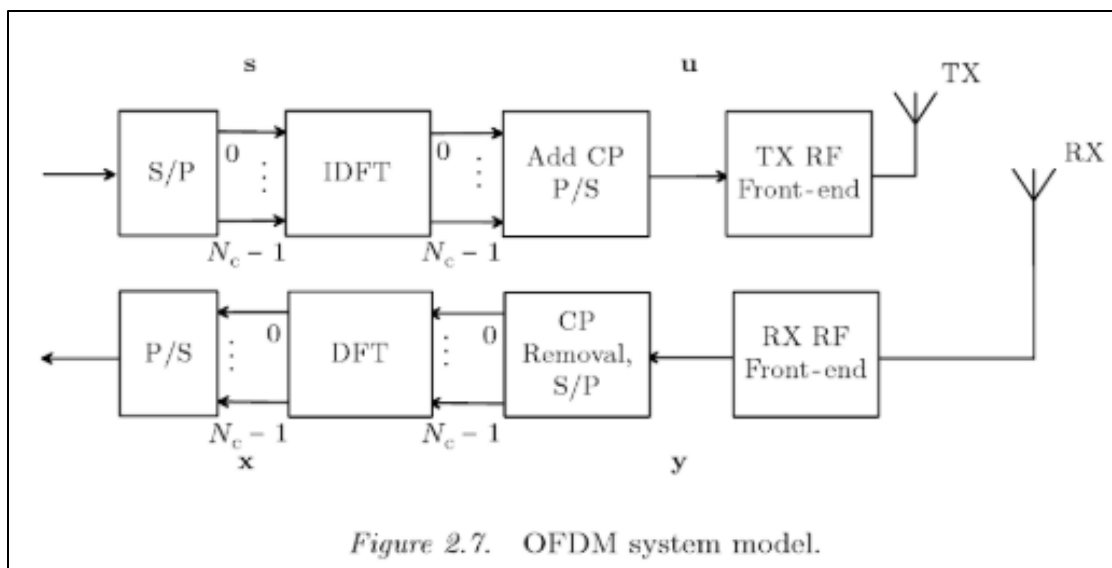

(Source: RF Imperfections in High-rate Wireless Systems: Impact and Digital Compression, Schenk, Tim)

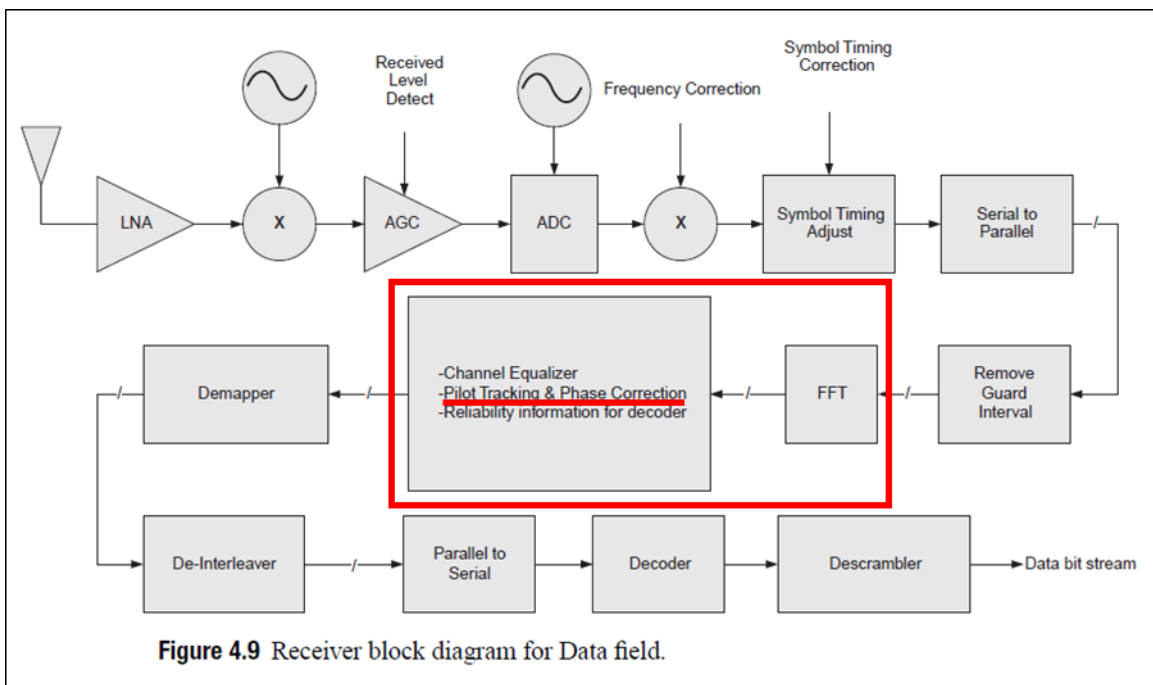

(Source: Next Generation Wireless LANs: 802.11n and 802.11ac, Perahia, Eldad and Stacey, Robert)

60. MediaTek has directly infringed at least through its making and use of the accused products through its own testing of the accused products, and through joint infringement with its affiliates, with its subsidiaries, with carriers, with retailers and other sales entities, with its business partners, with certification organizations, with testing organizations, with other agents of MediaTek, and/or with its customers and end-users, at least making and using the claimed apparatus. Such acts of infringement include directing or controlling other persons to engage in conduct satisfying one or more elements of the asserted claims, deriving a financial or other benefit from doing so. MediaTek's direction or control of its affiliates and end-users includes regularly contracting with those affiliates and end-users. Also, as explained further below, MediaTek took active steps and advised or directed customers and end-users to make and/or use the accused products in an infringing manner.

61. MediaTek has had actual knowledge of the '458 Patent at least as of the date when it was notified of the filing of this action. By the time of trial, MediaTek will have known and intended (since receiving such notice) that its continued actions would infringe and actively induce and contribute to the infringement of one or more claims of the '458 Patent.

62. MediaTek has also indirectly and willfully infringed, and continues to indirectly and willfully infringe, the '458 Patent, as explained further below in the "Additional Allegations Regarding Infringement" section.

63. American Patents has been damaged as a result of the infringing conduct by MediaTek alleged above. Thus, MediaTek is liable to American Patents in an amount that adequately compensates it for such infringements, which, by law, cannot be less than a reasonable royalty, together with interest and costs as fixed by this Court under 35 U.S.C. § 284.

64. American Patents has neither made nor sold unmarked articles that practice the '458 Patent, and is entitled to collect pre-filing damages for the full period allowed by law for infringement of the '458 Patent.

**ADDITIONAL ALLEGATIONS REGARDING INFRINGEMENT
AND PERSONAL JURISDICTION**

65. In addition to any specific products mentioned above, the accused products also include at least the following products: MediaTek Filogic 830, MediaTek Filogic 630 (MT7916), MediaTek Filogic 330 (MT7922), MediaTek Filogic 330P, MediaTek Filogic 130, MediaTek Filogic 130A, MediaTek MT7915, MediaTek MT7601U, MediaTek MT7603E, MediaTek MT7612U, MediaTek MT7615S, MediaTek MT7662U, MediaTek MT7921, MediaTek RT3070, MediaTek RT5370, MediaTek RT5592, MediaTek MT7601E, MediaTek MT7610U, MediaTek MT7612E, MediaTek MT7615B, MediaTek MT7668, MediaTek RT3562, MediaTek RT3573, MediaTek MT7603U, MediaTek MT7610E, MediaTek MT7615, MediaTek MT7662E,

MediaTek RT3062, MediaTek RT3593, MediaTek RT5572, MediaTek MT7622, MediaTek MT7688A, MediaTek RT3662, MediaTek MT5932, MediaTek MT7682, MediaTek MT7687F, MediaTek MT7628K/N/A, MediaTek MT7621A/N, MediaTek RT3883, MediaTek MT8167S, MediaTek MT7697, MediaTek MT7697H / HD, MediaTek MT7697D, MediaTek MT7623N/A, MediaTek MT7620N/A, MediaTek MT7688K, MediaTek MT7686, MediaTek MT7681, MediaTek T750, MediaTek Dimensity 700, MediaTek Dimensity 720, MediaTek Dimensity 800, MediaTek Dimensity 800U, MediaTek Dimensity 810, MediaTek Dimensity 820, MediaTek Dimensity 900, MediaTek Dimensity 920, MediaTek Dimensity 1000 Series (1000 and 1000+), MediaTek Dimensity 1000C, MediaTek Dimensity 1100, MediaTek Dimensity 1200, MediaTek Dimensity 1300, MediaTek Dimensity 8000, MediaTek Dimensity 8100, MediaTek Dimensity 9000, MediaTek Helio G96, MediaTek Helio G95, MediaTek Helio G90 Series (G90 and G90T), MediaTek Helio G88, MediaTek Helio G85, MediaTek Helio G80, MediaTek Helio G70, MediaTek Helio G35, MediaTek Helio G25, MediaTek Helio X30 (MT6799), MediaTek Helio X27 (MT6797X), MediaTek Helio X25 (MT6797T), MediaTek Helio X23 (MT6797D), MediaTek Helio X20 (MT6797), MediaTek Helio X10 (MT6795), MediaTek Helio P95, MediaTek Helio P90, MediaTek Helio P70, MediaTek Helio P65, MediaTek Helio P60, MediaTek Helio P60T, MediaTek Helio P35, MediaTek Helio P30, MediaTek Helio P25, MediaTek Helio P23, MediaTek Helio P22, MediaTek Helio P20, MediaTek Helio P18, MediaTek Helio P10, MediaTek Helio A25, MediaTek Helio A22, MediaTek Helio A20, MediaTek MT6753, MediaTek MT6752, MediaTek MT6750, MediaTek MT6739, MediaTek MT6738, MediaTek MT6737T, MediaTek MT6737, MediaTek MT6735, MediaTek MT6732, MediaTek MT6731, MediaTek MT6592, MediaTek MT8516 System on Module (SoM), MediaTek MT8516, MediaTek Pentonic 2000, MediaTek i500 (MT8385),

MediaTek i350 (MT8365), MediaTek i300A (MT8362A), MediaTek i300B (MT8362B), MediaTek MT2601, MediaTek MT5931, MediaTek Autus I20 (MT2712), MediaTek Kompanio 1380 (MT8195T), MediaTek Kompanio 820 (MT8192), MediaTek Kompanio 500 (MT8183), and MediaTek MT8173.

66. MediaTek has also indirectly infringed the '782 Patent, the '304 Patent, and the '458 Patent by inducing others to directly infringe the '782 Patent, the '304 Patent, and the '458 Patent. MediaTek has induced the end-users, MediaTek's customers, to directly infringe (literally and/or under the doctrine of equivalents) the '782 Patent, the '304 Patent, and the '458 Patent by using the accused products.

67. MediaTek took active steps, directly and/or through contractual relationships with others, with the specific intent to cause them to use the accused products in a manner that infringes one or more claims of the patents-in-suit, including, for example, Claim 30 of the '782 Patent, Claim 1 of the '304 Patent, and Claim 1 of the '458 Patent.

68. Such steps by MediaTek included, among other things, advising or directing customers and end-users to use the accused products in an infringing manner; advertising and promoting the use of the accused products in an infringing manner; and/or distributing instructions that guide users to use the accused products in an infringing manner.

69. MediaTek has performed these steps, which constitute induced infringement, with the knowledge of the '782 Patent, the '304 Patent, and the '458 Patent and with the knowledge that the induced acts constitute infringement.

70. MediaTek was and is aware that the normal and customary use of the accused products by MediaTek's customers would infringe the '782 Patent, the '304 Patent, and the '458 Patent. MediaTek's inducement is ongoing.

71. MediaTek has also induced its affiliates, or third-party manufacturers, shippers, distributors, retailers, or other persons acting on its or its affiliates' behalf, to directly infringe (literally and/or under the doctrine of equivalents) the '782 Patent, the '304 Patent, and the '458 Patent by importing, selling, offering to sell, and/or using the accused products.

72. MediaTek has at least a significant role in placing the accused products in the stream of commerce with the expectation and knowledge that they will be purchased by consumers in Texas and elsewhere in the United States.

73. MediaTek purposefully directs or controls the making of accused products and their shipment to the United States, using established distribution channels, for sale in Texas and elsewhere within the United States.

74. MediaTek purposefully directs or controls the sale of the accused products into established United States distribution channels, including sales to nationwide retailers, distributors, manufacturers, and design laboratories (including, but not limited to, Digi-Key, Amazon, Walmart, and Memory for Less).

75. MediaTek's established United States distribution channels include one or more United States based affiliates.

76. MediaTek purposefully directs or controls the sale of the accused products online and in nationwide retailers, including for sale in Texas and elsewhere in the United States, and expects and intends that the accused products will be so sold.

77. MediaTek purposefully places the accused products—whether by itself or through subsidiaries, affiliates, or third parties—into an international supply chain, knowing the accused products will be sold in the United States, including Texas. Therefore, MediaTek also facilitates the sale of the accused products in Texas.

78. MediaTek took active steps, directly and/or through contractual relationships with others, with the specific intent to cause such persons to import, sell, or offer to sell the accused products in a manner that infringes one or more claims of the patents-in-suit, including, for example, Claim 30 of the '782 Patent, Claim 1 of the '304 Patent, and Claim 1 of the '458 Patent.

79. Such steps by MediaTek included, among other things, making or selling the accused products outside of the United States for importation into or sale in the United States, or knowing that such importation or sale would occur; and directing, facilitating, or influencing its affiliates, or third-party manufacturers, shippers, distributors, retailers, or other persons acting on its or their behalf, to import, sell, or offer to sell the accused products in an infringing manner.

80. MediaTek performed these steps, which constitute induced infringement, with the knowledge of the '782 Patent, the '304 Patent, and the '458 Patent and with the knowledge that the induced acts would constitute infringement.

81. MediaTek performed such steps in order to profit from the eventual sale of the accused products in the United States.

82. MediaTek's inducement is ongoing.

83. MediaTek has also indirectly infringed by contributing to the infringement of the '782 Patent, the '304 Patent, and the '458 Patent. MediaTek has contributed to the direct infringement of the '782 Patent, the '304 Patent, and the '458 Patent by the end-user of the accused products.

84. The accused products have special features that are specially designed to be used in an infringing way and that have no substantial uses other than ones that infringe the '782

Patent, the '304 Patent, and the '458 Patent, including, for example, Claim 30 of the '782 Patent, Claim 1 of the '304 Patent, and Claim 1 of the '458 Patent.

85. As described above, the special features include improved wireless communication capabilities used in a manner that infringes the '782 Patent, the '304 Patent, and the '458 Patent.

86. The special features constitute a material part of the invention of one or more of the claims of the '782 Patent, the '304 Patent, and the '458 Patent and are not staple articles of commerce suitable for substantial non-infringing use.

87. MediaTek's contributory infringement is ongoing.

88. MediaTek has had actual knowledge of the '782 Patent, the '304 Patent, and the '458 Patent at least as of the date when it was notified of the filing of this action. Since at least that time, MediaTek has known the scope of the claims of the '782 Patent, the '304 Patent, and the '458 Patent, the products that practice the '782 Patent, the '304 Patent, and the '458 Patent, and that American Patents is the owner of the '782 Patent, the '304 Patent, and the '458 Patent.

89. By the time of trial, MediaTek will have known and intended (since receiving such notice) that its continued actions would infringe and actively induce and contribute to the infringement of one or more claims of the '782 Patent, the '304 Patent, and the '458 Patent.

90. Furthermore, MediaTek has a policy or practice of not reviewing the patents of others (including instructing its employees to not review the patents of others), and thus has been willfully blind of American Patents' patent rights. *See, e.g.*, M. Lemley, "Ignoring Patents," 2008 Mich. St. L. Rev. 19 (2008).

91. MediaTek has knowledge of the '782 Patent, the '304 Patent, and the '458 Patent.

92. MediaTek's customers have infringed the '782 Patent, the '304 Patent, and the '458 Patent.

93. MediaTek encouraged its customers' infringement.

94. MediaTek's direct and indirect infringement of the '782 Patent, the '304 Patent, and the '458 Patent is, has been, and/or continues to be willful, intentional, deliberate, and/or in conscious disregard of American Patents' rights under the patents.

95. American Patents has been damaged as a result of the infringing conduct by MediaTek alleged above. Thus, MediaTek is liable to American Patents in an amount that adequately compensates it for such infringements, which, by law, cannot be less than a reasonable royalty, together with interest and costs as fixed by this Court under 35 U.S.C. § 284.

JURY DEMAND

American Patents hereby requests a trial by jury on all issues so triable by right.

PRAYER FOR RELIEF

American Patents requests that the Court find in its favor and against MediaTek, and that the Court grant American Patents the following relief:

a. Judgment that one or more claims of the '782 Patent, the '304 Patent, and the '458 Patent have been infringed, either literally and/or under the doctrine of equivalents, by MediaTek and/or all others acting in concert therewith;

b. A permanent injunction enjoining MediaTek and its officers, directors, agents, servants, affiliates, employees, divisions, branches, subsidiaries, parents, and all others acting in concert therewith from infringement of the '782 Patent, the '304 Patent, and the '458 Patent; or, in the alternative, an award of a reasonable ongoing royalty for future infringement of the '782 Patent, the '304 Patent, and the '458 Patent by such entities;

c. Judgment that MediaTek account for and pay to American Patents all damages to and costs incurred by American Patents because of MediaTek's infringing activities and other conduct complained of herein, including an award of all increased damages to which American Patents is entitled under 35 U.S.C. § 284;

d. That American Patents be granted pre-judgment and post-judgment interest on the damages caused by MediaTek's infringing activities and other conduct complained of herein;

e. That this Court declare this an exceptional case and award American Patents its reasonable attorney's fees and costs in accordance with 35 U.S.C. § 285; and

f. That American Patents be granted such other and further relief as the Court may deem just and proper under the circumstances.

Dated: June 6, 2022

Respectfully submitted,

/s/ Zachariah S. Harrington

Matthew J. Antonelli

Texas Bar No. 24068432

matt@ahtlawfirm.com

Zachariah S. Harrington

Texas Bar No. 24057886

zac@ahtlawfirm.com

Larry D. Thompson, Jr.

Texas Bar No. 24051428

larry@ahtlawfirm.com

Christopher Ryan Pinckney

Texas Bar No. 24067819

ryan@ahtlawfirm.com

ANTONELLI, HARRINGTON

& THOMPSON LLP

4306 Yoakum Blvd., Ste. 450

Houston, TX 77006

(713) 581-3000

Stafford Davis

State Bar No. 24054605

sdavis@stafforddavisfirm.com

Catherine Bartles

Texas Bar No. 24104849
cbartles@stafforddavisfirm.com
THE STAFFORD DAVIS FIRM
815 South Broadway Avenue
Tyler, Texas 75701
(903) 593-7000
(903) 705-7369 fax

Attorneys for American Patents LLC