

FILED



4:31 pm, 7/18/23

Margaret Botkins
Clerk of Court

Alaina M. Stedillie (Wyoming Bar No. 6-4327)
astedillie@crowleyfleck.com
CROWLEY | FLECK
111 W 2nd St. #220
Casper, WY 82601
Telephone: (307) 265-2279
Facsimile: (307) 265-2307

Brian N. Platt (*pro hac vice forthcoming*)
bplatt@wnlaw.com
Collin Hansen (*pro hac vice forthcoming*)
chansen@wnlaw.com
WORKMAN NYDEGGER
60 East South Temple Suite 1000
Salt Lake City, UT 84111
Telephone: (801) 533-9800
Facsimile: (801) 328-1707

Counsel for Plaintiff BigNJ, Inc.

IN THE UNITED STATES DISTRICT COURT
FOR THE DISTRICT OF WYOMING

BIGNJ, INC.,)	
)	Case No. 23-CV-128-J
Plaintiff,)	
)	
vs.)	
)	
VACU VIN INNOVATIONS LTD.,)	
and AMZ WATCHDOG, LLC,)	
)	
Defendants.)	

**COMPLAINT FOR DECLARATORY JUDGMENT OF PATENT NON-
INFRINGMENT, DECLARATORY JUDGMENT OF PATENT
INVALIDITY, DECLARATORY JUDGMENT OF PATENT
UNENFORCEABILITY, TORTIOUS INTERFERENCE,
AND JURY DEMAND**

Plaintiff BigNJ, Inc. (“BigNJ”) hereby complains and alleges as follows against Defendants Vacu Vin Innovations Ltd. (“VV”) and AMZ Watchdog, LLC (“AMZW”):

INTRODUCTION

1. This case involves a design patent for a utensil rest. In response to the Defendants’ repeated and wrongful claims of patent infringement, Plaintiff BigNJ brings this civil action seeking a declaratory judgment of non-infringement, unenforceability, and invalidity of U.S. Design Patent D904,832 (“D832 Patent”) together with damages for tortious interference for the Defendants’ bad faith assertion of the invalid D832 Patent.

2. The design patent laws of the United States allow for a patent covering a “new, original, and ornamental design” 35 U.S.C. § 101. An inventor may be entitled to such a design patent *unless* “the claimed invention was patented, described in a printed publication, or in public use, on sale, or otherwise available to the public before the effective filing date of the claimed invention;” 35 U.S.C. § 102(a)(1).

3. It is a fundamental aspect of patent law that “no person is entitled to patent an ‘invention’ [or design] that has been ‘on sale’ more than one year before filing a patent application.” *Pfaff v. Wells Elecs., Inc.*, 525 U.S. 55, 57 (1998).

4. In this case, VV filed its design patent application for U.S. Patent D904,832 (“D832 Patent”) *more than one year* after VV’s affiliate began selling a product identical to the claimed design as depicted in VV’s patent application.

5. VV’s affiliate’s product and a figure from the D832 Patent are shown below:

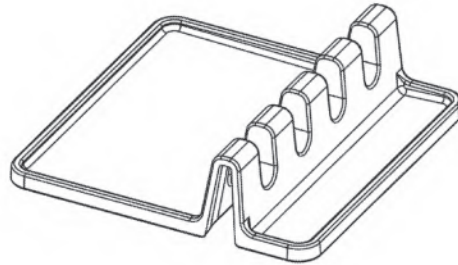

Tomorrow's Kitchen Facebook
(March 21, 2016)
([hyperlink](#) to Facebook photo)

U.S. Patent D904,832 (“D832 Patent”)
Application filed November 8, 2017
([hyperlink](#) to 'D832 Patent)

6. The 'D832 Patent is thus anticipated by VV's affiliate's identical prior art designs.

7. Even worse, VV knew of its affiliate's designs and—in a brazen violation of its duty of candor—failed to disclose those prior art designs to the USPTO Examiner.

8. Although both Defendants knew the 'D832 patent is invalid, VV and AMZW continued to repeatedly assert the 'D832 Patent against VV's competitors—including *Plaintiff BigNJ*—in an effort to gain a wrongful and unfair business advantage.

THE PARTIES

9. Plaintiff BigNJ, Inc., is a New York corporation with a principal place of business at 5 Yardley Drive, Dix Hills, New York 11746 (hereinafter “BigNJ” or “Plaintiff”).

10. Defendant Vacu Vin Innovations Ltd. is a Dutch corporation with a principal place of business at Groothandelsweg 1, Delfgauw 2645 EH, Netherlands (hereinafter

“VV” or “Defendant”). VV is part of the Dutch Creative Brands Group together with its affiliate “Tomorrow’s Kitchen.” VV does business within the State of Wyoming, is engaged in continuous and systematic business within the District of Wyoming, conducts and solicits business within this judicial district (including its patent enforcement business with AMZW), and VV derives substantial revenue from its activities in this judicial district.

11. Defendant AMZ Watchdog, LLC is a Wyoming limited liability corporation with a principal place of business at 1876 Horse Creek Rd., Cheyenne, WY 82009 (hereinafter “AMZW” or “Defendant”). AMZW is resident in the State of Wyoming, does business within the State of Wyoming, is engaged in continuous and systematic business within the District of Wyoming. In addition, AMZW conducts and solicits business within this judicial district, and derives substantial revenue from the sales of its products and/or services within this judicial district—including its sale of the services at issue in this litigation. On information and belief, AMZW sold services and has made offers for patent enforcement services in Wyoming and within this judicial district, including offers to VV.

JURISDICTION AND VENUE

12. This is an action for declaratory judgment of patent non-infringement, patent unenforceability, and patent invalidity arising under the patent laws of the United States, 35 U.S.C. §§ 1 *et seq.* The Court has subject matter jurisdiction under 28 U.S.C. § 1331 (federal question); 28 U.S.C. § 1338(a) (patents or trademarks); and 28 U.S.C. § 1367 (supplemental jurisdiction).

13. The Court has personal jurisdiction over AMZW because it resides in this judicial district and has had continuous and systematic contacts within the State of Wyoming. AMZW is headquartered in Wyoming, as stated on its website homepage:

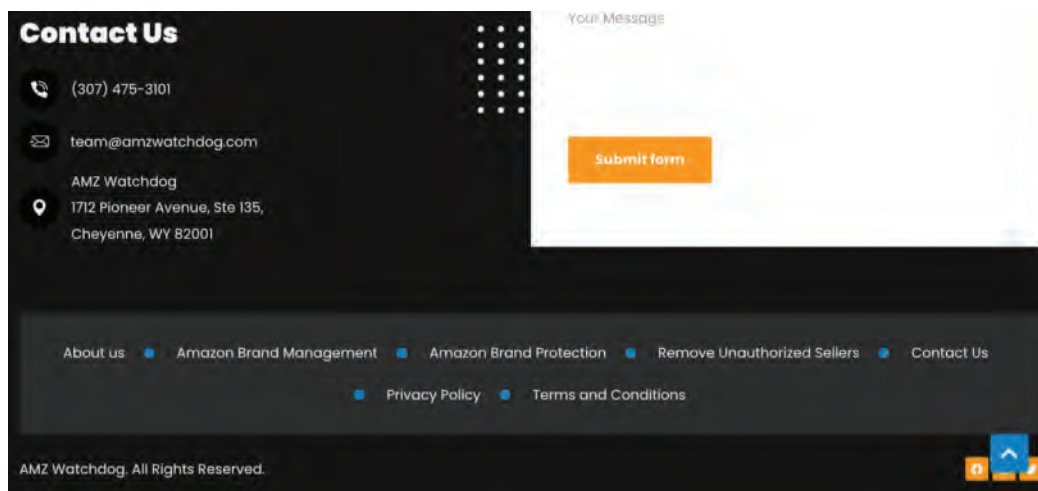

<https://www.amzwatchdog.com>

As shown above, AMZW is headquartered and maintains a principal place of business in Cheyenne, Wyoming. AMZW purposefully directs business contacts and activities at this judicial district and residents of this judicial district have used services and products offered or sold by AMZW. On information and belief, AMZW is registered with the State of Wyoming to do business in Wyoming as a limited liability company.

14. This Court has personal jurisdiction over VV because it is a foreign corporation that contracted with a resident of the State of Wyoming (i.e., AMZW) for the purposes of enforcing its intellectual property against competitors in the United States. On information and belief, VV engaged in continuous and systematic contacts with AMZW in the State of Wyoming, including its contacts related to the 'D832 Patent and with AMZW,

which is located within this judicial district. On information and belief, VV has purposefully directed its business contacts and activities at this judicial district for the purposes of effecting the patent enforcement of the 'D832 Patent.

15. This Court has federal question jurisdiction under 28 U.S.C. §§ 1331 and 1338(a) because this is a civil declaratory judgment action arising under the Patent Act. This Court has subject matter jurisdiction over the declaratory judgment claims pursuant to 28 U.S.C. §§ 2201 and 2202 because an immediate and substantial controversy exists between Plaintiff and Defendants with respect to whether the 'D832 Patent covers Plaintiff's products based on the Defendants claims to Amazon that the Plaintiff's products infringe the 'D832 Patent, which has resulted in the suspension of the Plaintiffs' product listings on Amazon.com.

16. This Court has supplemental jurisdiction over Plaintiff's claims of tortious interference with economic or business relationship under 28 U.S.C. § 1367 because those claims relate to the same operative nucleus of fact as Plaintiff's claims for declaratory judgment of non-infringement of the 'D832 Patent.

17. Venue is proper in this judicial district under 28 U.S.C. § 1391(b) because a substantial part of the events giving rise to this claim took place in this judicial district, because Defendant AMZW resides and transacts business within this judicial district and because Defendant VV contracted with Defendant AMZW to provide services within this judicial district, and because Plaintiff suffered harm in this judicial district.

FACTUAL ALLEGATIONS

18. Plaintiff sells a silicone utensil rest on Amazon.com, as shown below at Amazon ASINs¹ including B0874S275K (the “Accused Products”).

The screenshot shows the Amazon product page for a 'Grey Silicone Spoon holder for Stove Top with Drip Pad (Two Pack)'. The product is priced at \$7.99, a 11% discount from the list price of \$8.99. It is sold by 'Cooler Kitchen' and has a 4.7-star rating from 3,564 reviews. The listing includes an 'Amazon's Choice' badge and a promotional code 'COOLER20' for a 20% discount on 3 select items. The product specifications are: Material: Silicone, Color: Gray, Brand: Cooler Kitchen, Item Dimensions: 9.06 x 6.3 x 2.76 inches, and Pattern: Solid. The page also shows delivery options, a 'FREE Returns' badge, and a 'FREE Prime delivery Monday, July 24' offer.

19. Silicone utensil rest products are not new. In fact, such products have been available from sellers like the VV (and its affiliate Tomorrow’s Kitchen) since early 2016. For example, such products are shown below in a product catalog produced by VV’s affiliate Tomorrow’s Kitchen as early as **January 2016**:

¹ Amazon assigns each product listing on its marketplace a unique “Amazon Standard Identification Number” which is abbreviated as “ASIN.” Each ASIN is associated with a unique product listing on Amazon, which maintains millions of ASINs associated with numerous unique product listings.



Tomorrow's Kitchen
2016 Catalog (Cover)



Tomorrow's Kitchen
2016 Catalog (Page 28)

See Exhibit B
(Tomorrow's Kitchen 2016 Catalog)

20. Tomorrow's Kitchen is an affiliate of VV.
21. The Tomorrow's Kitchen product catalog depicted products identical to the subject of the 'D832 Patent and the Accused Products as early as January 2016.
22. In addition to the Tomorrow's Kitchen product catalog, VV's affiliate Tomorrow's Kitchen depicted such products on Facebook as early as March 21, 2016.
23. Tomorrow's Kitchen made the following Facebook post on **March 21, 2016**:



See Exhibit C

(Tomorrow's Kitchen Facebook Post – March 21, 2016)

24. In addition to its Facebook pages, Tomorrow's Kitchen operated an Amazon UK ASIN (B01CPB3CK6) that offered the same products for sale as early as **March 12, 2016**:

Tomorrows Kitchen (was Vacu Vin 46703606 Kitchen Utensil Tray, Grey)

Brand: Tomorrows Kitchen
4.9 ★★★★★ 27 ratings

£7⁶⁴

FREE Returns
Colour Name: Grey

Material: Silicone
Colour: Grey
Brand: Tomorrows Kitchen
Item dimensions L x W x H: 10 x 10 x 10 millimetres
Item weight: 90 Grams

About this item

- Keep counters clean and utensils organized with the Utensil Rest by Tomorrow's Kitchen
- Made of non-slip, heat-safe silicone
- Four notches hold up to 4 utensils at once
- Raised edges keep spills on the rest, and not on your surfaces
- A perfect gift for all the chefs in your life

Free delivery on your first order
Select the 'Free delivery on first order' option at checkout. See conditions.

Buy it with

This item: Tomorrows Kitchen (was Vacu Vin 46703606 Kitchen Utensil Tray, Grey) £7⁶⁴

Sambonet Rock 52562-B1 Stainless Steel Crockery Set for 6 People, 24 Pieces: 6 Forks, 6... £57⁷⁷ (£9.63/count)

Total price: £65.41
Add both to Basket

One of these items is dispatched sooner than the other. Show details

Product information

Technical Details

Brand	Tomorrows Kitchen
Model Number	46703606
Colour	Grey
Product Dimensions	1 x 1 x 1 cm; 90 Grams
Material	Silicone
Item Weight	90 g

Additional Information

ASIN	B01CPB3CK6
Customer Reviews	4.9 ★★★★★ 27 ratings 4.9 out of 5 stars
Best Sellers Rank	655,572 in Home & Kitchen (See Top 100 in Home & Kitchen) 566 in Utensil Holders & Organisers
Date First Available	12 Mar. 2016

See Exhibit D
(Tomorrow's Kitchen Amazon UK Listing – ASIN B01CPB3CK6)

25. In addition to its Amazon UK site, Tomorrow's Kitchen also operated an Amazon US ASIN (B01HNZYMSA) that offered these same products for sale as early as

June 28, 2016:

The screenshot shows the Amazon product page for the 'Tomorrow's Kitchen Silicone Utensil Rest, Grey' (ASIN 46703606). The page includes a search bar with the product name, navigation tabs, and a main product image of the grey silicone rest. To the right of the image, the product title and ASIN are displayed, along with a 4.7-star rating from 6,563 reviews. Below the title, a 'Material' section lists 'Silicone' and other specifications like 'Color: Gray', 'Brand: Vacu Vin', and 'Item Dimensions: 5.5 x 1.6 x 5.5 inches'. An 'About this item' section lists four bullet points: keeping counters clean, non-slip heat-safe silicone, holding up to 4 utensils, and spill-resistant edges. A 'Customer ratings by feature' section shows high ratings for durability (4.9), ease of use (4.8), and ease of cleaning (4.8). On the right side, there are buttons for 'Add to List' and 'Have one to sell? Sell on Amazon'.

Product information	
Product Dimensions	5.5 x 1.6 x 5.5 inches
Item Weight	3.52 ounces
Manufacturer	Vacu Vin
ASIN	B01HNZYMSA
Item model number	46703606
Customer Reviews	4.7 - 6,563 ratings 4.7 out of 5 stars
Best Sellers Rank	#49,448 in Kitchen & Dining (See Top 100 in Kitchen & Dining) #150 in Spoon Rests
Is Discontinued By Manufacturer	No
Date First Available	June 28, 2016

Feedback
 Would you like to [tell us about a lower price?](#)

See Exhibit E
 (Tomorrow’s Kitchen Amazon US Listing – ASIN B01HNZYMSA)

26. In addition to Amazon, Tomorrow’s Kitchen also operated its own website that offered its Utensil Rest products for sale as early as **July 5, 2016**, as demonstrated by

the Wayback Machine® archives of Tomorrow's Kitchen's website:

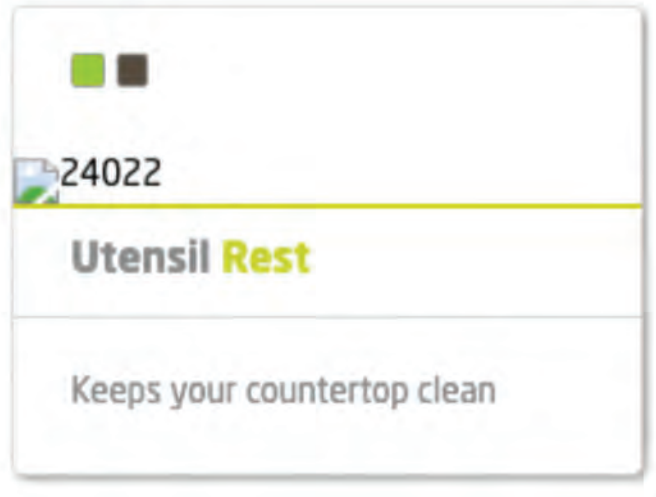

See Exhibit F

(<http://tomorrows.kitchen:80/22601/Products>)
 (data captured by Archive.org on July 5, 2016)

27. Notwithstanding the foregoing public disclosure, on **November 8, 2017**—*more than one year after Tomorrow's Kitchen disclosed the claimed design*—VV filed for patent protection for the Tomorrow's Kitchen utensil rest product. *See* Exhibit A.

28. During the patent prosecution of the 'D832 Patent, VV owed a duty of candor to the USPTO to disclose information material to patentability. *See* 37 C.F.R. § 1.56.

29. VV knew of prior public uses, sales, and disclosures of the claimed design by Tomorrow's Kitchen.

30. VV knew of the Tomorrow's Kitchen 2016 Catalog.

31. VV knew of the Tomorrow's Kitchen 2016 Amazon Listing B01CPB3CK6

32. VV knew of Tomorrow's Kitchen's own website, which advertised products for sale including a utensil holder identical to the 'D832 Patent.

33. VV knew of Tomorrow's Kitchen's Facebook postings.

34. Notwithstanding its duty of candor to the USPTO during the prosecution of the 'D832 Patent, VV failed to disclose to the USPTO any of its prior sales, prior disclosures, and prior public uses of the claimed design. *See* Exhibit G.

35. VV's prior sales, prior disclosures, and prior public uses were material to patentability.

36. If the Examiner of the 'D832 Patent had been aware of Tomorrow's Kitchen's prior sales, prior disclosures, and prior public uses of the claimed design, the Examiner would not have allowed the 'D832 Patent to issue.

37. But without the knowledge of the relevant prior art—*i.e.*, *Tomorrow's Kitchen's prior sales, prior disclosures, and prior public uses of the claimed design*—the USPTO allowed the 'D832 Patent to issue.

38. VV's actions in obtaining the 'D832 Patent were in bad faith because VV had actual knowledge of Tomorrow's Kitchen's prior sales, prior disclosures, and prior public uses of the claimed design and failed to disclose that information to the USPTO.

39. Upon the issuance of the 'D832 Patent, VV and AMZW began to aggressively assert the 'D832 Patent on Amazon.com against VV's competitors.

40. On May 13, 2023, Michiel Rodrigues Pereira with VV asserted the 'D832 Patent against three Amazon ASINs owned by Plaintiff BigNJ: B0874SHJFX, B0874S275K, and B0874S11MY. *See* Exhibit H.

41. BigNJ advised Amazon that the 'D832 Patent was invalid *at least* because it had been included in the Tomorrow's Kitchen January 2016 catalog. Upon learning this information, Amazon reinstated BigNJ's product listings.

42. On July 3, 2023, Chris Keef of AMZW again asserted the 'D832 Patent against one ASIN owned by Plaintiff BigNJ: B0874SHJFX. *See* Exhibits I.

43. BigNJ again advised Amazon that the 'D832 Patent was invalid *at least* because it had been included in the Tomorrow's Kitchen January 2016 catalog. Upon learning this information, Amazon once again reinstated BigNJ's product listing.

44. BigNJ contacted Chris Keef of AMZW on July 3, 2023, and advised that the 'D832 Patent was invalid and should not be asserted against BigNJ's product listings.

45. In response, Chris Keef of AMZW called BigNJ and left the following voicemail:

Hey, good afternoon Brandon. Chris Keef calling on behalf of your voicemail this morning in regards to the Vacu Vin design patent claim. 1-317-028-2501. I'll refer you to legal counsel, Rosenbaum and Segall. Speak to Rob Segall. His phone number is 212-256-8490. I'll respectfully request all correspondence go through Rob and his uh team who operate the legal matters on our behalf. That's Rob Segall 212-256-8490.

46. On July 4, 2023, AMZW again asserted the 'D832 Patent against three Amazon ASINs owned by Plaintiff BigNJ: B0874SHJFX, B0874S275K, and B0874S11MY. *See* Exhibit J.

47. The impact on BigNJ's Amazon account was immediate. BigNJ's product listings for the Accused Products were disabled and BigNJ experienced substantial business disruption and thousands of dollars in lost revenue. BigNJ was forced to disable its "Prime Day" specials on two of the biggest shopping days of the year. *See* Exhibit K.

48. AMZW was unwilling to engage in a constructive dialog with BigNJ regarding the invalid 'D832 Patent and was unwilling to withdraw its wrongful complaints, which caused further damages to BigNJ.

49. AMZW's actions were in bad faith because—when presented with evidence that the 'D832 Patent was invalid—AMZW refused to withdraw its wrongful complaints of patent infringement for the 'D832 Patent.

50. Because of VV's and AMZW's wrongful acts, BigNJ lost and continues to lose thousands of dollars per day in online sales.

FIRST CAUSE OF ACTION
Declaratory Judgment of Patent Invalidity of the 'D832 Patent
(Against VV)

51. BigNJ incorporates and realleges each and every allegation in the preceding Paragraphs as if fully set forth herein.

52. VV is the owner of the 'D832 Patent.

53. The 'D832 Patent is invalid at least under 35 U.S.C. §§ 102 and 103 in view of the prior art, including but not limited to, Tomorrow's Kitchen's own products, prior public use, prior sales, and prior offers for sale, which occurred more than one-year before the filing of the patent application that would become the 'D832 Patent. *See* Exhibits B, C, D, E, F.

54. The 'D832 Patent was not filed until November 8, 2017. *See* Exhibit A.

55. The 'D932 Patent is invalid in view of the prior art.

56. BigNJ is entitled to a declaratory judgment that the 'D832 Patent is invalid.

SECOND CAUSE OF ACTION

Declaratory Judgment of Unenforceability of the 'D832 Patent (Against VV)

57. BigNJ incorporates and realleges each and every allegation in the preceding Paragraphs as if fully set forth herein.

58. VV is the owner of the 'D832 Patent.

59. During the patent prosecution of the 'D832 Patent, VV was aware of Tomorrow's Kitchen's prior sales, prior disclosures, and prior public uses of the claimed design. *See* Exhibits B, C, D, E, F. Such prior sales, prior disclosures, and prior public uses of the claimed design—which were identical to the Defendant's design patents—were material to the patentability of the 'D832 Patent. Tomorrow's Kitchen was an affiliate of VV and VV would have been aware of such products.

60. In violation of its duty of candor to the USPTO, and with the intent to deceive the USPTO, VV did not disclose Tomorrow's Kitchen's products, prior sales, prior disclosures, and prior public uses during prosecution. "Inequitable conduct resides in failure to disclose material information, or submission of false information, with an intent to deceive . . ." *Kingsdown Medical Consultants Ltd. v. Hollister Inc.*, 863 F.2d 867, 872 (Fed. Cir. 1988) (en banc). VV committed inequitable conduct by intentionally failing to disclose Tomorrow's Kitchen's products, sales, disclosures, and public uses—which were prior art—to the USPTO.

61. BigNJ is entitled to a declaratory judgment that the 'D832 Patent is unenforceable.

THIRD CAUSE OF ACTION
Declaratory Judgment of Non-Infringement of the 'D832 Patent
(Against VV)

62. BigNJ incorporates and realleges each and every allegation in the preceding Paragraphs as if fully set forth herein.

63. VV is the owner of the 'D832 Patent.

64. The 'D832 Patent is invalid at least under 35 U.S.C. §§ 102 and 103 in view of the prior art, including but not limited to, Tomorrow's Kitchen's products which were sold, offered for sale, in public use, or disclosed to the public more than one-year before the filing date of the 'D832 Patent. *See* Exhibits B, C, D, E, F.

65. The 'D832 Patent was not filed until November 8, 2017. *See* Exhibit A. The 'D832 Patent is invalid in view of the prior art. “It is axiomatic that one cannot infringe an invalid patent.” *Commil USA, LLC v. Cisco Sys., Inc.*, 720 F.3d 1361, 1368 (Fed. Cir. 2013); *see also Richdel, Inc. v. Sunspool Corp.*, 714 F.2d 1573, 1580 (Fed.Cir.1983) (“The claim being invalid there is nothing to be infringed.”).

66. Because the 'D832 Patent is invalid and should never have issued, there is “nothing to be infringed” and BigNJ is entitled to declaratory judgment that it does not infringe the 'D832 Patent.

FOURTH CAUSE OF ACTION
Tortious Interference
(Against VV and AMZW)

67. BigNJ incorporates and realleges each and every allegation in the preceding Paragraphs as if fully set forth herein.

68. Through BigNJ's Amazon store and its product listings at ASIN B0874SHJFX, B0874S275K, and B0874S11MY, BigNJ had a valid contractual relationship and business expectancy for the sale of its utensil rest products and was selling thousands of dollars in such products on Amazon.

69. On or about May 13, 2023, July 3, 2023, and July 4, 2023, Defendants VV and AMZW asserted the 'D832 Patent in a series of wrongful complaints against BigNJ's Amazon ASINs. *See* Exhibits H, I, J.

70. In order to assert the 'D832 Patent in a complaint against BigNJ's Amazon ASINs, Defendants necessarily had knowledge of those multiple ASINs and of BigNJ's ongoing business relationship with Amazon.

71. In wrongfully asserting the 'D832 Patent in a complaint against BigNJ's Amazon listings, Defendants intended to induce or cause a breach or termination of that relationship by requesting that Amazon remove such listings.

72. The assertion of the 'D832 Patent—*which Defendant VV knew to be invalid*—was an interference for an improper purpose using improper means. In addition, the Defendant AMZW's *refusal* to remove complaints against BigNJ's product listings once it learned the facts that the 'D832 Patent was invalid—was also an interference for an improper purpose using improper means.

73. Defendants VV's and AMZW's wrongful assertion of the 'D832 Patent—and refusal to withdraw such complaints once they learned the 'D832 Patent was invalid—are actions undertaken in bad faith.

74. Because Defendants VV and AMZW knew or learned of the existence of the Tomorrow's Kitchen prior art products—and because the Defendants VV and AMZW thereafter refused to withdraw their Complaints against ASINs B0874SHJFX, B0874S275K, and B0874S11MY, the Defendant's actions were undertaken in bad faith.

75. Before the Defendant's interference with its Amazon listing, BigNJ was selling thousands of dollars of the Accused Products through its product listings at ASINs

B0874SHJFX, B0874S275K, and B0874S11MY. The Defendants' tortious interference with BigNJ's business caused substantial reputational and economic damages through (a) disabled product listing; (b) lost product sales; (c) reputational damage to BigNJ's Amazon account, and (d) other damages to BigNJ's product listing, inventory, and business.

PRAYER FOR RELIEF

Wherefore, BigNJ respectfully prays that the Court enter judgment in its favor and against the Defendants and award the following relief:

A. A judgment in favor of BigNJ and against VV declaring that the 'D832 Patent is invalid.

B. A judgment in favor of BigNJ and against VV declaring that VV engaged in inequitable conduct before the USPTO and that the 'D832 Patent is unenforceable.

C. A judgment in favor of BigNJ and against VV declaring that BigNJ has not and does not infringe the 'D832 Patent.

D. An order and judgment permanently enjoining Defendants VV and AMZW and its officers, directors, employees, agents, licensees, representatives, affiliates, related companies, servants, successors and assigns, and any and all persons acting in privity or in concert with any of them, from further acts of wrongful assertion of the 'D832 Patent.

E. A judgment that this is an exceptional case, pursuant to 35 U.S.C. § 285, together with an award to BigNJ of its costs and reasonable attorneys' fees.

E. A judgment that Defendants VV and AMZW tortiously interfered with BigNJ's contract or business expectancy in the sale of its utensil rest products.

F. A judgment awarding BigNJ all damages sustained by BigNJ and/or all gains, profits, and advantages derived by the Defendants VV and AMZW as a result of their wrongful acts and tortious interference.

G. A judgment awarding BigNJ punitive damages as a result of the Defendants VV's and AMZW's willful and intentional acts of tortious interference.

I. Any other relief the Court deems just and proper under all circumstances.

Demand for Trial by Jury

BigNJ demands a jury trial on all matters triable to a jury.

DEMAND FOR JURY TRIAL

Pursuant to Rule 38(b) of the Federal Rules of Civil Procedure, Plaintiffs demand a jury trial on all matters triable to a jury.

DATED this 18th day of July 2023.

Respectfully submitted,

CROWLEY | FLECK

By: /s/ Alaina M. Stedillie
Alaina M. Stedillie

WORKMAN NYDEGGER

Brian N. Platt (*pro hac vice*)

Collin Hansen (*pro hac vice*)

Counsel for Plaintiff BigNJ, Inc.



US00D904832S

(12) **United States Design Patent**
Medeiros Santos et al.

(10) **Patent No.:** **US D904,832 S**
 (45) **Date of Patent:** **** Dec. 15, 2020**

(54) **UTENSIL REST**
 (71) Applicant: **Vacu Vin Innovations Ltd.**, Delfgauw (NL)
 (72) Inventors: **Rui Medeiros Santos**, Rotterdam (NL); **Sandra van Oosterbaan-Rijnen**, Barendrecht (NL); **Delphine Buyse**, Voorburg (NL)

7,975,857 B2 * 7/2011 Restis A47L 19/02 206/553
 D689,744 S * 9/2013 Tarantino D19/86
 8,668,171 B2 * 3/2014 Tarantino A47G 21/14 220/500
 D723,875 S * 3/2015 Elattrache D7/637
 D740,619 S * 10/2015 Elliott D7/637
 2002/0158031 A1 * 10/2002 Powers A47J 47/16 211/41.11

* cited by examiner
Primary Examiner — Derrick E Holland
Assistant Examiner — Janice Patyk

(**) Term: **15 Years**
 (21) Appl. No.: **29/625,265**

(22) Filed: **Nov. 8, 2017**
 (51) **LOC (12) CI.** **07-07**
 (52) **U.S. CL.**
 USPC **D7/637**
 (58) **Field of Classification Search**
 USPC D3/273, 274; D7/631, 637-641, 550.1; D9/420-426, 432; D19/77, 81-86; 206/553, 557, 562, 564; 211/60.1, 70.1, 211/70.7; 220/23.83
 CPC A47G 21/06; A47G 21/14; A47G 29/08; B65D 43/169; B65D 45/00; B67B 7/16; B67B 7/44
 See application file for complete search history.

(57) **CLAIM**
 The ornamental design for a "utensil rest," as shown and described.

DESCRIPTION
 FIG. 1 is a top perspective view of a utensil rest, showing our new design;
 FIG. 2 is a front view thereof;
 FIG. 3 is a right side view thereof;
 FIG. 4 is a left side view thereof;
 FIG. 5 is a top view thereof;
 FIG. 6 is a bottom view thereof; and,
 FIG. 7 is a back view thereof.
 The broken lines in the figures illustrate the portions of the design that form no part of the claimed design.

(56) **References Cited**
 U.S. PATENT DOCUMENTS
 6,604,714 B1 * 8/2003 Hall A47F 7/0035 206/232
 D504,587 S * 5/2005 Root D6/534

1 Claim, 7 Drawing Sheets

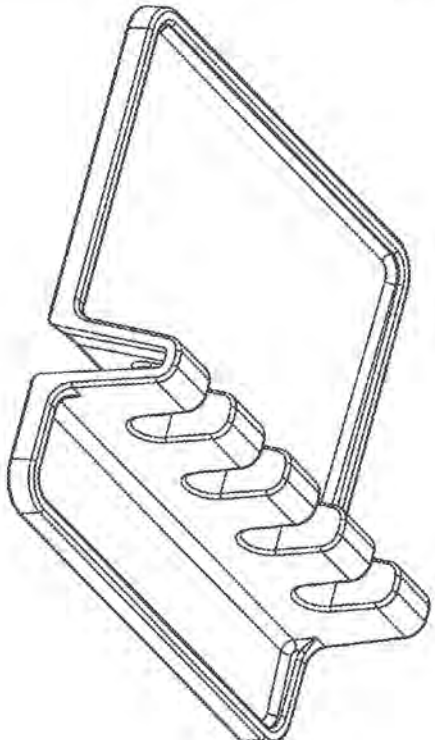

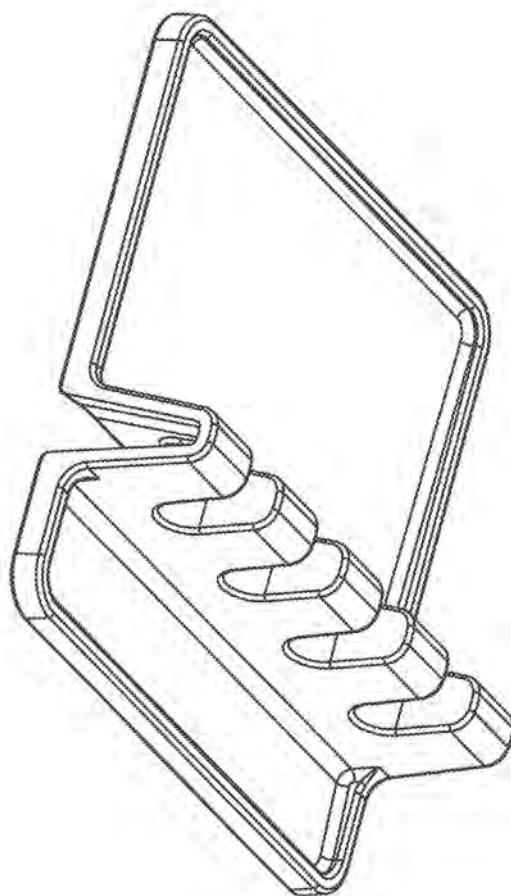

FIGURE 1

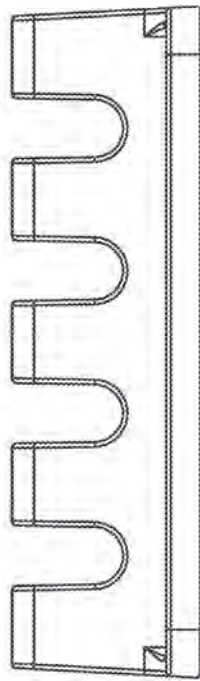

FIGURE 2

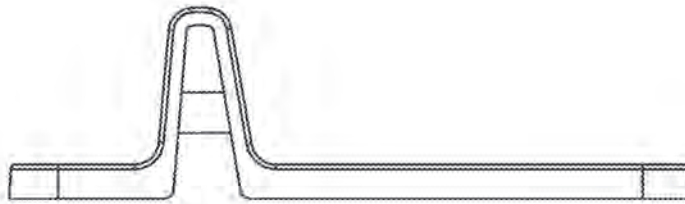

FIGURE 3



FIGURE 4

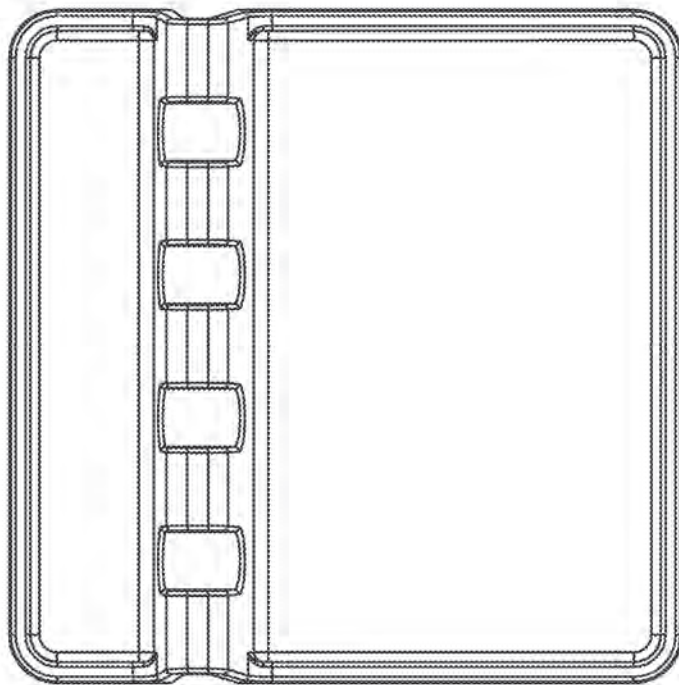

FIGURE 5

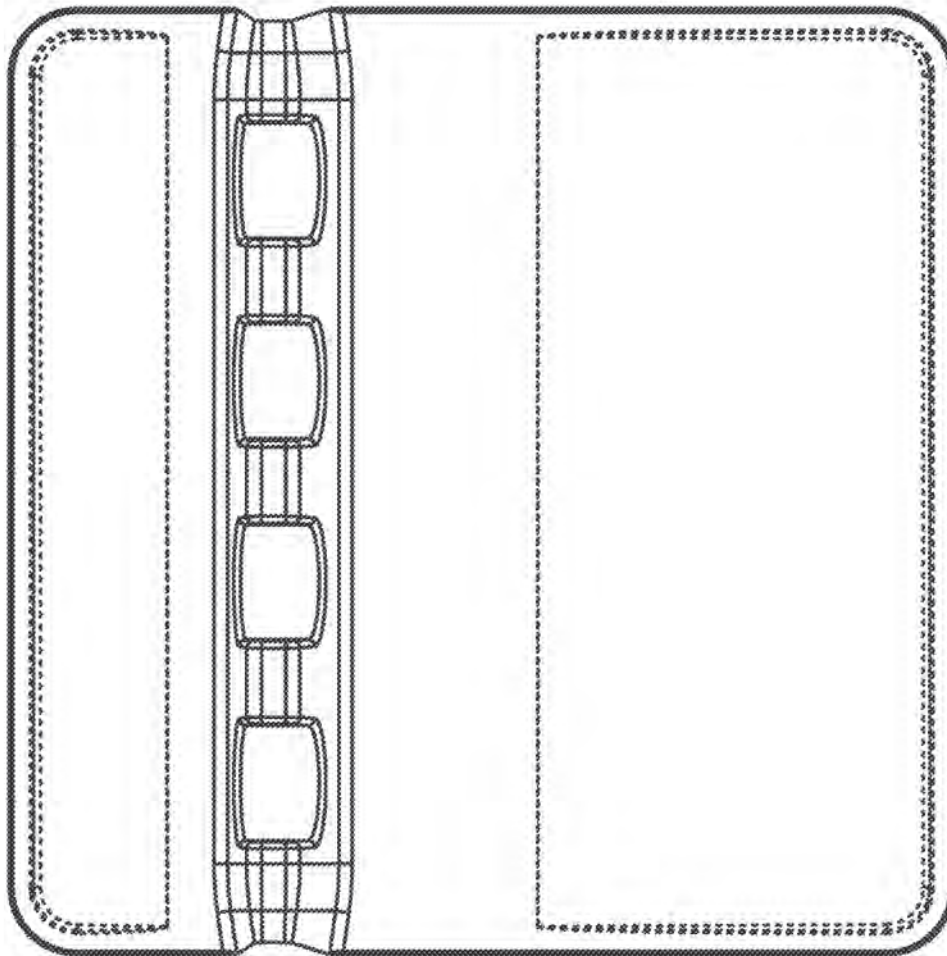

FIGURE 6

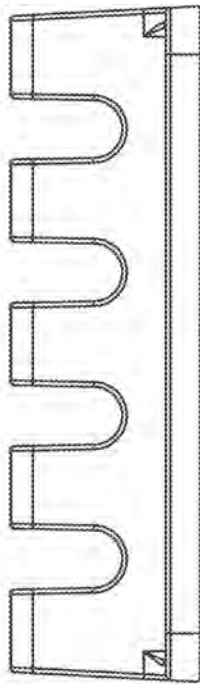

FIGURE 7

PREPARE TO BE INSPIRED 2016

**TOMORROW'S.
KITCHEN**

Shake out
treats!

Keep on-the-go
snacks fresh!

Airtight seal for
guaranteed freshness!

Open freshness
with a "POP"!

English | Dutch | German



INDEX

FRUIT PREPARATION

Pineapple Slicers	6
Citrus Peeler	8
Strawberry Huller	8
Melon Slicer	8
Fruit Set	9
Coconut Opener	9

FOOD PREPARATION

Garlic Press	10
Double Mortar & Pestle	10
Cheese Grater	11
Jar Opener	11
Cutting Board & Tray	12
Nut Cracker	13
Slice & Catch	13
Dry & Store	14
Single Serve Steamer	15

Cool Plate	16
Quick Skewer	16
Instant Marinater	17

VACUUM STORAGE CONTAINERS

Vacuum Storage Containers	18
Vacuum Pump	19
Vacuum Coffee Saver	19

POPSOME DISPENSERS

PopSome Candy & Nuts	20
PopSome Sugar & Rice	21
PopSome Flavor	21
PopSome Toddler	22
PopSome Cake Decorating Set	23
PopSome Herbs & Spices	23

Z-GO PRODUCTS

Banana Box	25
Tomato Box	25
Kiwi Box	25

Citrus Carafe Juicer & Squeezer	26
Active Cooling Carafe	26
Serve & Stack	27
Bread & Dip	27
Egg Pillow	28
Utensil rest	28
Foldable Trivet	29
Trivet Rings	29

+TOOLS

Pasta Spoon +Timer	30
Turner +Tongs	31
Cheese Slicer +Rind Peeler	31
Peeler +Holder	31
Kitchen +Nutmeg Grater	32
Citrus Grater +Zester	32
Vegetable Knife +Brush	32
Apple Corer +Knife	33
Whisk +Brush	33
Cake Server + Divider	33



EN During its 30 years of business, International Innovation Company has always been one of the most innovative companies in the housewares industry. This family-owned company has been a trendsetting company since the introduction of its first innovation in 1986: the Vacuum Wine Saver, invented by the founder of the company Bernd Schneider. Today, the second generation of the family is taking the company to the next level by introducing several new initiatives. First of all, a new sales concept will be launched called 'Dutch Creative Brands' including new packaging designs for all existing products and secondly the addition of a new brand called 'Tomorrow's Kitchen', the first step in creating an exciting brand portfolio. International Innovation Company's philosophy is to produce as much as possible within the borders of Europe and at the same time creating jobs for those who need some help in society. Today, over 150 mentally or physically disadvantaged people are involved in the production and assembly of almost every product distributed to over 85 countries in the world either through numerous distributors or our own offices.

NL Gedurende de 30 jaar waarin International Innovation Company actief is, wordt het bedrijf beschouwd als een van de meest innovatieve bedrijven binnen de branche waarin het actief is. Dit familiebedrijf is een ware trendsetter sinds de introductie van de eerste innovatie in 1986: de Vacuum Wine Saver, uitgevonden door oprichter van het bedrijf Bernd Schneider. Vandaag de dag staat de tweede generatie klaar om met het bedrijf de volgende stap te zetten door middel van het introduceren van verschillende initiatieven. Waaronder de lancering van een nieuw verkoopconcept genaamd 'Dutch Creative Brands' in combinatie met een compleet nieuwe verpakkinglijn voor het bestaande assortiment en daarnaast de lancering van het nieuwe merk genaamd 'Tomorrow's Kitchen' dat aan het begin staat van een nieuw merkenportfolio. De filosofie van International Innovation Company is om de productie grotendeels

binnen de grenzen van Europa te faciliteren en daarnaast ook banen te creëren voor diegene binnen de samenleving die dat extra beetje hulp goed kunnen gebruiken. Zo zijn er vandaag de dag meer dan 150 mensen met een geestelijke of lichamelijke beperking betrokken bij de productie en assemblage van bijna elk artikel dat wordt gedistribueerd naar meer dan 85 landen met behulp van eigen kantoren of het wereldwijde kanaal van distributeurs.

DE Seit ihrer mittlerweile 30-jährigen Firmengeschichte ist die International Innovation Company eine der innovativsten Unternehmen ihrer Branche. Das Familienunternehmen ist seit der ersten Neuheit 1986 ein Trendsetter: Die Vakuum Weinpumpe, erfunden vom Firmengründer Bernd Schneider. In der mittlerweile zweiten Generation der Familie wird das Unternehmen zukunftsträchtig ausgerichtet. Unter anderem ergibt sich daraus ein neues Verkaufskonzept genannt 'Dutch Creative Brands' mit neuen Verpackungen der bestehenden Produktpalette, aber auch eine weitere neue Marke entsteht: 'Tomorrow's Kitchen'. Die International Innovation Company ist sehr darauf bedacht, soviel als möglich in Europa zu produzieren und damit hilfsbedürftige Menschen hier zu unterstützen. Aktuell arbeiten über 150 Menschen mit einer Behinderung in unserer Produktion und wir versenden unsere Produkte in über 85 Länder, teils durch eigene Niederlassungen, teils durch Distributoren.



IIC international branches

- 1 IIC Netherlands
- 2 IIC Germany
- 3 IIC UK
- 4 IIC Belgium
- 5 IIC France
- 6 IIC Spain
- 7 IIC USA / Canada



EN International Innovation Company has its own prime time national television show generating thousands of ideas directly based upon consumer experiences. Not all ideas fit the Dutch Creative Brands positioning and distribution channels. Therefore, International Innovation Company is also fully capable of developing products for third parties by offering a complete package from the designing of the products, at no cost, to supplying products anywhere in the world. International Innovation Company can be best described as an idea factory that generates products instead of ideas. It is a one stop shopping experience for companies that want to be innovative in their business, without having to face the difficulties of setting up their own design department or outsourcing without the knowledge of how to set up production.

NL International Innovation Company genereert met zijn eigen nationale televisieshow duizenden ideeën die gebaseerd zijn op de ervaringen van de consument. Niet alle ideeën passen binnen de strategie van Dutch Creative Brands en zijn distributiekanalen. Daarom ontwikkelt International Innovation Company ook producten voor derden door het aanbieden van een compleet pakket van productontwerp, zonder dat daar kosten aan zijn verbonden, tot het leveren van producten overal ter wereld. International Innovation Company kan het best worden beschreven als een ideeënfabriek dat producten genereert in plaats van ideeën.

DE Die International Innovation Company verfügt zu besten Sendezeiten über ihre eigene nationale TV-Show. In Dieser werden tausende Ideen, basierend auf Verbrauchererfahrungen, vorgestellt. Nicht alle dieser Ideen passen zu den Vertriebskanälen von Dutch Creative Brands. Hierfür entwickelt die International Innovation Company für weitere Unternehmen indem ein vollständiges Gesamtpaket von Designerstellung bis hin zum fertigen Produkt. Die International Innovation Company kann als Ideenwerkstatt welche Produkte entwickelt und produziert und nicht nur als Ideengeber gesehen werden. Es ist wie „alles aus einer Hand“ für innovative Firmen, die sich nicht um Entwicklung und Produktion sowie viele

weitere zeitraubende Details wie das Bilden eines eigenen Designteams, kümmern möchten.

EN The core family values on social responsibility have been put to life in IIC's production partner 'Voor Elkaar', which is also part of International Innovation Company. 'Voor Elkaar' is the Dutch translation of 'For Each Other' and also means 'Accomplished'. As the name suggests, the focus of this company is to 'accomplish' the production and assembly of high-level quality products, and at the same time helping people that need help getting back into the working society. This way they can recover their self-esteem and be of great value, something we believe our society should do 'For Each Other'. Production is not limited to affiliated companies but is also suitable for interested third parties from different lines of business.

The importance of social responsibility is not only bound to the Dutch society, as IIC is also the founder of the 'Sharing Success Foundation'. This foundation guarantees that 100% of the donations received, from entrepreneurs willing to share their success, are being spent wisely in cooperation with the Liliane Foundation. Today, the foundation has helped over 50.000 disabled children and has realized many useful facilities in developing countries.

NL De familiale kernwaarden op het gebied van sociale verantwoordelijkheid komen tot leven in de productiepartner 'Voor Elkaar', wat eveneens onderdeel is van International Innovation Company. 'Voor Elkaar' slaat zowel op het klaarstaan voor een ander als op iets succesvol volbrengen. Zoals de naam weergeeft, is het belangrijk dat productie en assemblage van kwaliteitsproducten, tezamen met het bieden van hulp bij de terugkeer binnen de werkmaatschappij, succesvol wordt volbracht. Dit initiatief is bedoeld om werknemers hun zelfvertrouwen te laten herwinnen en het gevoel van toegevoegde waarde te geven, iets dat onze maatschappij moet doen 'Voor Elkaar'. De productie is niet gelimiteerd tot gelieerde ondernemingen, maar eveneens beschikbaar voor geïnteresseerde bedrijven actief in andere branches.

Het belang van maatschappelijk verantwoord ondernemen is niet alleen gebonden aan de Nederlandse samenleving, daar IIC ook eveneens oprichter is van stichting 'Sharing Success'. Deze stichting garandeert dat 100% van haar gegeneerde inkomsten, afkomstig van ondernemers die hun succes willen delen, in samenwerking met het Lilianegoed op de juiste plek terechtkomt. Vandaag de dag heeft de stichting meer dan 50.000 kinderen met een beperking geholpen tezamen met de realisatie van noodzakelijke voorzieningen in ontwikkelingslanden.

DE Die Kernwerte der Familie im Bereich sozialer Verantwortung werden durch IIC's Produktionspartner ebenfalls gelebt. Dies wird in Holland 'Voor Elkaar' genannt und trifft ebenfalls auf die Familie zu. 'Voor Elkaar' bedeutet 'Für einander' und zwar 'vollständig'. Wie der Name sagt, ist der Fokus des Unternehmens vollständig auf die Produktion und Entwicklung hochwertiger Produkte ausgerichtet. Zeitgleich wird körperlich beeinträchtigt Menschen die Möglichkeit gegeben, am Leben durch Arbeit und sozialer Zugehörigkeit teilzunehmen und sie zu integrieren; Wir glauben, etwas, was Alle in unserer Gesellschaft tun sollten. Dieses Unternehmen arbeitet für Firmen aus jeder Branche und nicht nur für mit der Branche verbundenen Firmen. Die Wichtigkeit und Bedeutung der sozialen Verantwortung ist nicht nur in den Niederlanden ein Thema. IIC ist der Gründer der 'Sharing Success Foundation'. Diese gemeinnützige Stiftung garantiert, dass 100 % der Spenden aus Wirtschaft und Privat Spendern in Kooperation mit der Liliane Foundation sinnvoll eingesetzt werden. Bis heute hat die Stiftung über 50.000 behinderten Kindern zu einem besseren Leben verholfen sowie in einigen Entwicklungsländern gemeinnützige Einrichtungen realisiert.



EN The new sales approach 'Dutch Creative Brands' has a clear focus on several core values of the company. International Innovation Company is a Dutch company with creativity being one of the key success factors in its 30 years of existence. The new approach is part of a repositioning of the existing Vacu Vin brand as the leading supplier of wine and bar accessories. The well-established Vacu Vin brand name will be used for a complete range of essential items that enable consumers and professionals to enjoy wine and cocktails. As a result of this new approach the total product assortment has grown over 30%! This allows the company to offer a complete range that suits the needs of every customer the company supplies. From high-level department stores to mass-market supermarkets and everything in between, the Vacu Vin brand is able to offer appropriate items that fit its customer's retail strategies.

DE Firma und unsere Kreativität ist einer der Erfolgsfaktoren unserer 30-jährigen Firmengeschichte. Das neue Verkaufsargument ist Teil einer Veränderung der existierenden Marke Vacu Vin als Marktführer in Wein- und Baraccessoires. Der populäre Markenname Vacu Vin wird künftig für eine vollständige Produktlinie, bestehend aus Wein- und Baraccessoires für den Haus- und professionellen Gebrauch, genutzt. Im Ergebnis wächst das Sortiment in diesem Bereich um über 30 % und bietet alle benötigten Produkte an. Vom Fach Einzelhandel bis hin zum Supermarkt und Allen dazwischen bietet Vacu Vin passende Produkte für jeden Verbraucher und eine optimale Strategielösung für den Händler an. Innovative Produkte zu produzieren wird stets der Fokus von Vacu Vin sein.



NL Het nieuwe verkoopconcept 'Dutch Creative Brands' heeft een heldere visie op verschillende kernwaarden van het bedrijf. International Innovation Company is een Nederlands bedrijf met creativiteit als een van de succesfactoren in het 30-jarig bestaan. Deze nieuwe aanpak is onderdeel van de herpositionering van het merk Vacu Vin als toonaangevende leverancier van wijn- en baraccessoires. De sterk gevestigde merknaam Vacu Vin zal gebruikt worden voor een complete reeks met essentiële items die het een ieder mogelijk maakt om te kunnen genieten van wijn en cocktails. Als gevolg van deze nieuwe aanpak is het assortiment gegroeid met meer dan 30%! Deze groei maakt het mogelijk om met een complete lijn baraccessoires te voorzien in de behoefte van elke klant waaraan het bedrijf levert. Van exclusieve warenhuizen tot supermarkten toegankelijk voor het grote publiek en alles daartussenin. Het merk Vacu Vin is in staat om een assortiment te bieden dat aansluit bij de retailstrategie van zijn klanten.



Unser neues Verkaufsargument 'Dutch Creative Brands' fokussiert einige unserer Grundwerte. International Innovation Company ist eine holländische





EN Besides the existing Vacu Vin brand, International Innovation Company has also launched a new brand called 'Tomorrows Kitchen'. This new brand will focus exclusively on innovative kitchen items that can be used during the preparation of foods, but also allow consumers to enjoy themselves at the dining table. The word 'Tomorrow' has a double meaning. It is expressing the innovative character of the products as well as the company's social values in which high value is being given to our future responsibility to society.

Both brands belonging to the 'Dutch Creative Brands' concept have a constant stream of new innovations coming up. An in-house design team is constantly working on tomorrow's gadgets with a focus on functionality and at the same time bringing a smile to the user's face. Offering these unique innovations will always be the core focus of Dutch Creative Brands.

NL Naast het huidige merk Vacu Vin, lanceert International Innovation Company een nieuw merk genaamd 'Tomorrow's Kitchen'. Dit nieuwe merk zal zich richten op innovatieve keukensitems die toegepast kunnen worden zowel tijdens het prepareren van eten, als tijdens het serveren op de eettafel. De naam 'Tomorrow' heeft een dubbele betekenis. Het benadrukt zowel het innovatieve karakter van het merk als de sociale waarden waar het bedrijf veel waarde hecht aan de toekomstige verantwoordelijkheid naar de samenleving toe.

Beide merken die toebehoren aan het 'Dutch Creative Brands' concept, hebben een constante stroom van nieuwe productinnovaties. Een intern gefaciliteerd team van designers is voortdurend aan het werk om de gadgets van morgen te ontwikkelen met de focus op zowel functionaliteit als het bezorgen van een glimlach op het gezicht van de eindgebruiker. Het aanbieden van deze unieke innovaties loopt als een rode draad door de visie van 'Dutch Creative Brands'.

DE Neben der existierenden Marke Vacu Vin führen wir künftig die neue Marke 'Tomorrow's Kitchen'. Diese neue Marke fokussiert sich exklusiv auf innovative Küchenhelfer und Produkte rund um den gedeckten Tisch. Das Wort 'Tomorrow' in dem Markennamen hat eine Doppelbedeutung. Als Erstes unterstreicht es den innovativen und zukunftssträchtigen Charakter; als Zweites drückt es unsere auch zukünftig weiter wachsende soziale Verantwortung aus.

Beide Marken gehören zum 'Dutch Creative Brands' Konzept und profitieren von der konstanten Innovationskraft sowie zukünftiger Produkte. Das hauseigene Designteam sorgt mit seiner stetigen Arbeit an neuen Produkten und Fokus auf Funktionalität für diese Innovationskraft.



“Offering these unique innovations and store concepts will always be the core focus of DCB”

5

PINEAPPLE SLICER & WEDGER

FRESH PINEAPPLE SLICES OR BITE-SIZE CHUNKS IN SECONDS



Pineapple Slicer & Wedger J-Hook

Article number: 4862260
 EAN Code: 8714793 486225
 UPC Code: 084256 486221

Units/ Carton: 6
 Gross weight: 1,12 kg
 (outercase): 2,47 lbs
 Dimensions: 43,2 x 26,8 x 17 cm
 (outercase): 17,01 x 10,55 x 6,69 inch

EN The ingenious Pineapple Slicer will peel, core and slice a fresh pineapple in just 30 seconds. It works like a corkscrew, removing the flesh in perfectly formed rings leaving the core in the shell. One turn, one slice, or the whole pineapple in one go.

- Shell remains intact
- Removes the core from the rings
- Quickly and easily
- With separate wedger

NL De ananassnijder verwijdert de kern, schilt en snijdt in één beweging een verse ananas in minder dan 30 seconden. De ananassnijder werkt als een kurkentrekker en snijdt het vruchtvlees in prachtig gevormde schijven. In één keer de hele ananas of slechts één draai voor een enkele schijf.

- Houdt de schil intact
- Verwijdert de kern
- Snel en gemakkelijk
- Met losse partjessnijder

DE Der raffinierte Ananasschneider schält, schneidet und holt eine Ananas in nur 30 Sekunden aus. Er arbeitet wie ein Kurkenzieher und löst die in perfekt geschnittenen Ringe wobei er den Strunk in der Fruchtschale belässt. Ein Dreh, ein Schnitt und die Ananas ist fertig.

- Schale wird nicht beschädigt
- Entfernt den Kern
- Schnell und einfach
- Mit separaten Portionierer



PINEAPPLE SLICER & WEDGER

EASILY CREATE SLICES OR BITE-SIZE CHUNKS IN SECONDS



Pineapple Slicer & Wedger Gift Pack

Article number: 48722006
 EAN Code: 8714793 487222
 UPC Code: 084256 487228

Units/ Carton: 6
 Gross weight: 1,04 kg
 (outercase): 2,28 lbs
 Dimensions: 37,3 x 31,6 x 12 cm
 (outercase): 14,69 x 12,44 x 4,72 inch



PINEAPPLE SLICER

THE ORIGINAL SINCE 1992

- EN • Shell remains intact
 - Removes the core from the rings
 - Quickly and easily
- NL • Houdt de schil intact
 - Verwijdert de kern
 - Snel en gemakkelijk
- DE • Schale wird nicht beschädigt
 - Entfernt den Kern
 - Schnell und einfach



Pineapple Slicer J-Hook

Article number: 48522606
 EAN Code: 8714793 485228
 UPC Code: 084256 485224

Units/ Carton: 6
 Gross weight: 0.73 kg
 (outer case) 1.61 lbs
 Dimensions: 27.8 x 14.1 x 27.4 cm
 (outer case) 10.94 x 5.55 x 10.79 inch

PINEAPPLE SLICER

IN 30 SECONDS A FRESHLY SLICED PINEAPPLE



Pineapple Slicer Pink/Blue/Purple J-Hook

Article number: 48500606
 EAN Code: 8714793 485005
 UPC Code: 084256 485002

Units/ Carton: 6
 Gross weight: 0.73 kg
 (outer case) 1.61 lbs
 Dimensions: 27.8 x 14.1 x 27.4 cm
 (outer case) 10.94 x 5.55 x 10.79 inch

PINEAPPLE SLICER & WEDGER

THREE KNIVES FOR DIFFERENT SIZE PINEAPPLES



Pineapple Slicer & Wedger Set of 3 (Small, Medium, Large)

Article number: 48702606
 EAN Code: 8714793 487024
 UPC Code: 084256 487020

Units/ Carton: 6
 Gross weight: 1.84 kg
 (outer case) 4.05 lbs
 Dimensions: 41.9 x 14.6 x 30.7 cm
 (outer case) 16.5 x 5.75 x 12.09 inch



PINEAPPLE SLICER & WEDGER

HIGH PERFORMANCE STAINLESS STEEL DESIGN



Pineapple Slicer & Wedger Stainless Steel Gift Pack

Article number: 4872360
 EAN Code: 8714793 487239
 UPC Code: 084256 487235

Units/ Carton: 6
 Gross weight: 1.70 kg
 (outer case) 3.75 lbs
 Dimensions: 37.3 x 31.6 x 12 cm
 (outer case) 14.69 x 12.44 x 4.72 inch





CITRUS PEELER

EASY PEASY PEELING!



Citrus Peeler

Article number: 47575606
 EAN Code: 8714793 475755
 UPC Code: 084256 475751

Units/Case: 6
 Gross weight: 0.20 kg
 (outer case) 0.44 lbs
 Dimensions: 17.1 x 11.4 x 12.2 cm
 (outer case) 6.73 x 4.49 x 4.8 inch



STRAWBERRY HULLER

LESS WASTE, MORE BERRY!



Strawberry Huller

Article number: 47581505
 EAN Code: 8714793 475816
 UPC Code: 084256 475812

Units/Case: 6
 Gross weight: 0.33 kg
 (outer case) 0.29 lbs
 Dimensions: 16.8 x 15.3 x 12 cm
 (outer case) 6.61 x 6.02 x 4.72 inch



MELON SLICER

SLICE, SCOOP AND SERVE!



Melon Slicer

Article number: 47566606
 EAN Code: 8714793 475663
 UPC Code: 084256 475669

Units/Case: 6
 Gross weight: 0.53 kg
 (outer case) 1.17 lbs
 Dimensions: 27.8 x 14.1 x 27.4 cm
 (outer case) 10.94 x 5.55 x 10.79 inch



FRUIT SET

QUICKLY PREPARE ALL OF YOUR FAVORITE FRUITS



Fruit Set

Article number: 48892606
 EAN Code: 8714793 488922
 UPC Code: 084256 488928

Units/Case: 6
 Gross weight: 1,71 kg
 (outer case) 3,77 lbs
 Dimensions: 41,9 x 14,6 x 30,7 cm
 (outer case) 16,5 x 5,75 x 12,09 inch



**SLICES
 YOUR
 PINEAPPLE,
 HULLS
 YOUR
 STRAWBERRY
 PEELS
 YOUR
 CITRUS
 AND SLICES
 YOUR
 MELON**

TOMORROW'S
 KITCHEN

COCONUT OPENER

DIVIDE COCONUT INTO EQUAL HALVES



Coconut Opener

Article number: 4653560
 EAN Code: 8714793 465334
 UPC Code: 084256 465330

Units/Case: 6
 Gross weight: 1,30 kg
 (outer case) 2,87 lbs
 Dimensions: 32,6 x 9,8 x 9,2 cm
 (outer case) 12,83 x 3,86 x 3,62 inch

EN With the Coconut Opener you can easily prepare a coconut. First puncture the soft 'eye' and pour out the coconut liquid into a glass. Then simply hit the coconut several times while turning it. The Coconut Opener will easily divide the coconut into equal halves which then allows easy access to the coconut flesh. Bring an exotic holiday experience into your home with this smart product.

NL Met de Coconut Opener kun je nu gemakkelijk een kokosnoot klaarmaken. Perforeer het "zachte" oog van de kokosnoot en schenk de vloeistof in een glas. Sla vervolgens meerdere malen op de kokosnoot terwijl u de kokosnoot draait. De Coconut Opener verdeelt een kokosnoot gemakkelijk in twee gelijke helften en zorgt ervoor dat u gemakkelijk bij het vruchtvlies kan. Breng het gevoel van een tropische bestemming in huis met de slim vormgegeven Coconut Opener.

DE Mit dem Kokosnussöffner wird das Öffnen der Kokosnuss zum Kinderspiel. Um an die leckere Kokosmilch zu gelangen, stechen Sie zuerst mit dem kleinen Dorn in das weiche „Auge“ der Kokosnuss und lassen die Milch in ein Glas fließen. Dann bearbeiten Sie die Längsseite der Kokosnuss in dem Sie mit der Metallseite des Öffners kräftig auf die Schale schlagen und die Kokosnuss dabei in der Hand drehen. Die Kokosnuss wird dadurch in 2 gleiche Teile geteilt und dem Genuss des gesunden „Fleisches“ steht nichts mehr im Weg.

**NO MORE
GARLIC
WILL GO
TO WASTE
DUE TO
THE UNIQUE
SCRAPING
MECHANISM**

**TOMORROW'S.
KITCHEN**



GARLIC PRESS

SCRAPE THE MAXIMUM OUT YOUR GARLIC!



Unique
scrape lever!



Garlic Press

Article number: 6883660
EAN Code: 8714793 688360
LPC Code: 084256 688366

Units/Cartron: 6
Gross weight: 2,35 kg
(outer case) 5,18 lbs
Dimensions: 35,8 x 16,0 x 8,5 cm
(outer case) 14,09 x 6,30 x 3,35 inch.



DOUBLE MORTAR & PESTLE

TWO-SIDED MORTAR FUNCTION



Double Mortar & Pestle

Article number: 4630160
EAN Code: 8714793 463011
LPC Code: 084256 463017

Units/Cartron: 4
Gross weight: 2,81 kg
(outer case) 6,19 lbs
Dimensions: 25,4 x 13,6 x 20,8 cm
(outer case) 10 x 5,35 x 8,19 inch.

EN A mortar is a useful kitchen tool for grinding and mixing various rough herbs and spices. With this tool you can easily make your own spice mixes and use them as a starting point for a delicious sauce, soup or marinade. The robust white ceramic mortar offers a sturdy base for the wooden pestle. The ceramic mortar base can be used on both sides to always provide the appropriate size! The mortar can easily be stored free of dust by turning the broadest side down and put the pestle upright into the small mortar base.

- Diameter mortar 100 and 54 mm
- Dust free storage

NL Een vijzel is een handig hulpmiddel bij het malen en mengen van diverse grove kruiden en specerijen. Hierdoor maak je gemakkelijk je eigen kruidenmengsels als basis voor een lekkere saus, soep of marinade. De vijzel van robuust wit keramiek biedt een stevige basis voor de houten stamper. De vijzelbasis is aan beide zijden te gebruiken, zodat je altijd het geschikte formaat vijzel beschikbaar hebt. De vijzel kan gemakkelijk stofvrij opgeborgen worden door de brede kant naar beneden te draaien en de stamper rechtop te zetten in de kleine vijzelkom.

- Diameter vijzel 100 en 54 mm
- Stofvrij opbergen

DE Ein Mörser ist ein nützliches Küchengerät zum mahlen und mixen verschiedener Kräuter und Gewürze. Mit diesem Hilfsmittel können Sie ganz einfach Ihre eigenen Gewürze mischen und diese zur Vorbereitung einer köstlichen Sauce, Suppe oder Marinade nutzen. Der robuste, weiße Keramikmörser bietet eine solide Basis für den hölzernen Stößel. Der Keramikmörser kann beidseitig, je nach gewünschter Größe, genutzt werden. Der Mörser kann ganz einfach mit der breiten Seite nach unten und dem Stößel in der kleinen Mörserbasis gelagert werden, so dass beides nicht einstaubt.

- Durchmesser Mörser 100 und 54 mm
- Staubfreie Lagerung

CHEESE GRATER

GREAT- GREAT- GRATER



Cheese Grater

Article number: 4655460
 EAN Code: 8714793 465541
 UPC Code: 084256 465547

Units/ Carton: 6
 Gross weight: 0,86 kg
 (outer case): 1,89 lbs
 Dimensions: 27,3 x 18,6 x 22,6 cm
 (outer case): 10,75 x 7,32 x 8,9 inch

EN The Cheese Grater is an easy to use grater with a detachable reservoir. The grated cheese is collected in the detachable reservoir to allow easy pouring on the desired meal, or be served as a separate dish. Because of its sturdy grater, the Cheese Grater can be used with half soft to hard cheeses.

NL De Kaasrasp is een gemakkelijke handrasp met een uitneembaar opvangreservoir. De geraspte kaas wordt binnenin opgevangen zodat deze gemakkelijk over de gewenste maaltijd kan worden gestrooid of apart kan worden opgediend. Door zijn stevige rasp kan de kaasrasp voor halfzachte tot harde kazen gebruikt worden.

DE Die Käse Reibe ist einfach im Gebrauch und besitzt einen abnehmbaren Behälter. Der geriebene Käse wird im abnehmbaren Behälter gesammelt und erlaubt das einfache portionieren auf zubereitetem Essen oder zum separaten Reservieren. Aufgrund der robusten Reibe ist die Käse Reibe für halbfesten- und Hartkäse geeignet.

- Convenient detachable cheese reservoir
- Grater can be used with half soft to hard cheeses

- Handig uitneembaar opvangreservoir
- Rasp geschikt voor halfzachte tot harde kazen

- Leicht abnehmbarer Käsebehälter
- Einsetzbar für halbfesten- und Hartkäse



JAR OPENER

NO MORE STUCK LIDS



Jar Opener

Article number: 6084260
 EAN Code: 8714793 688421
 UPC Code: 084256 688427

Units/ Carton: 6
 Gross weight: 0,90 kg
 (outer case): 1,98 lbs
 Dimensions: 35,8 x 16,0 x 8,5 cm
 (outer case): 14,09 x 6,30 x 3,35 inch



CUTTING BOARD & TRAY

ALWAYS AN ORGANIZED WORKTOP



Cutting Board & Tray

Article number: 4685260
 EAN Code: 6714793 468528
 UPC Code: 084256 468524

Units/ Carton: 4
 Gross weight: 5.63 kg
 (outer case): 12.40 lbs
 Dimensions: 38.6 x 31.4 x 22.5 cm
 (outer case): 15.2 x 12.36 x 8.86 inch

EN The Cutting Board features a built-in tray to allow you to quickly and easily separate food from waste. Simply slide open the tray to reveal an ideal place to put peellings and waste, leaving enough space to chop food!

NL De Cutting Board is een handige snijplank, uitgerust met een lade om gesneden etenswaren van het snijafval te scheiden. Snijresten kunnen met één beweging in de lade worden geschoven zodat er voldoende ruimte overblijft om te snijden.

DE Das Schneidebrett ist mit einem Auffangbehälter ausgestattet, um es Ihnen zu ermöglichen, schnell und einfach Lebensmittel vom Schnittabfall zu trennen. Durch einfaches schieben den Behälter bis zur gewünschten Stelle für Schale und Reste öffnen. Jetzt bleibt genug Platz um Lebensmittel zu schneiden.

- Includes sliding tray to separate food and waste
- No mess on the worktop
- Non-slip rubber feet
- Cutting board made of bamboo, a renewable resource
- Bamboo board absorbs little moisture
- Bamboo has natural antibacterial properties

- Lade om snijafval van voedsel te scheiden
- Aanrecht blijft schoon
- Antislip voetjes om wegschuiven te voorkomen
- Snijplank gemaakt van bamboe, een herwinbare grondstof
- Bamboe snijplank absorbeert weinig vocht
- Bamboe heeft natuurlijke antibacteriële eigenschappen

- Aufbewahrungsbehälter für Kleingeschnittenes oder Reste
- Kein Durcheinander auf der Arbeitsplatte
- Rutschsichere GummifüÙe
- Schneidebrett aus Bambus, ein nachwachsender Rohstoff
- Bambus Brett absorbiert Feuchtigkeit
- Bambus hat natürliche antibakterielle Eigenschaften

**TAKES UP LITTLE SPACE
 AND SAVES TIME
 SEPARATING FOOD
 FROM WASTE**

**TOMORROW'S
 KITCHEN**



NUT CRACKER

FOR SERVING AND CRACKING



Nut Cracker

Article number:	6782260
EAN Code:	8714793 678026
UPC Code:	084256 678022
Units/ Carton:	6
Gross weight (outer case):	2,37 kg
Dimensions (outer case):	34,8 x 18,1 x 20,2 cm
	13,7 x 7,13 x 7,95 inch

EN The Nut Cracker is unique in its use and design. Thanks to the ergonomically formed handles and a clever hinge, the Nut Cracker requires little strength to operate. The Nut Cracker is also designed to function as a decorative nut tray.

- Easy to use
- Functions as a nut tray
- Requires little strength

NL De Nut Cracker is een unieke notenkraker in zowel gebruik als design. De ergonomisch gevormde handvatten en het slimme scharniersysteem zorgen ervoor dat u met minimale moeite uw noten kunt kraken. Bovendien is de Nut Cracker zo vormgegeven dat hij tevens dienst doet als een fraaie serveerschaa.

- Gemakkelijk in gebruik
- Houder fungeert als serveerschaa
- Weinig kracht nodig

DE Der Nussknacker ist einmalig im Gebrauch und Design. Dank der ergonomischen Form und des cleveren Druckpunktes benötigt der Nussknacker nur minimalen Kraftaufwand. Der Nussknacker wurde ebenfalls als dekorativer Aufbewahrungsbehälter entwickelt.

- Einfache Bedienung
- Funktion auch als Nussbehälter
- Geringer Kraftaufwand.

SLICE & CATCH

CATCH THE SLICES IN THE CUP



Slice & Catch

Article number:	4651460
EAN Code:	8714793 465169
UPC Code:	084256 465165
Units/ Carton:	6
Gross weight (outer case):	1,00 kg
Dimensions (outer case):	28 x 27,1 x 10,4 cm
	11,02 x 10,67 x 4,09 inch

EN The Slice & Catch can slice several vegetables and fruits and catches the parts in the ergonomically formed cup. You can slice both vegetables and fruits by simply pressing the cup on the desired vegetable or fruit to make the stainless steel blades in the bottom of the cup do their work. The Slice & Catch works easy, safe and can be used by anyone.

NL Met de Slice & Catch snijdt u groente en fruit in een handomdraai. Onderin de ergonomisch gevormde beker bevindt zich een serie roestvrijstalen mesjes waarmee u moeiteloos verschillende soorten groente of fruit kan snijden. U drukt simpelweg de beker op de te snijden groente of fruit en deze vangt de gesneden plakjes binnenin op. De Slice & Catch werkt snel en veilig en is door iedereen te gebruiken.

DE Der Slice & Catch schneidet verschiedene Obst- und Gemüsesorten und fängt das Schnittgut im ergonomisch geformten Behälter auf. Mit leichtem Druck auf den Behälter schneiden die Edelstahlmesser im Boden das ausgewählte Obst oder Gemüse klein. Der Slice & Catch arbeitet einfach, sicher und kann von jedem benutzt werden.

DRY & STORE

FOLDABLE SALAD SPINNER

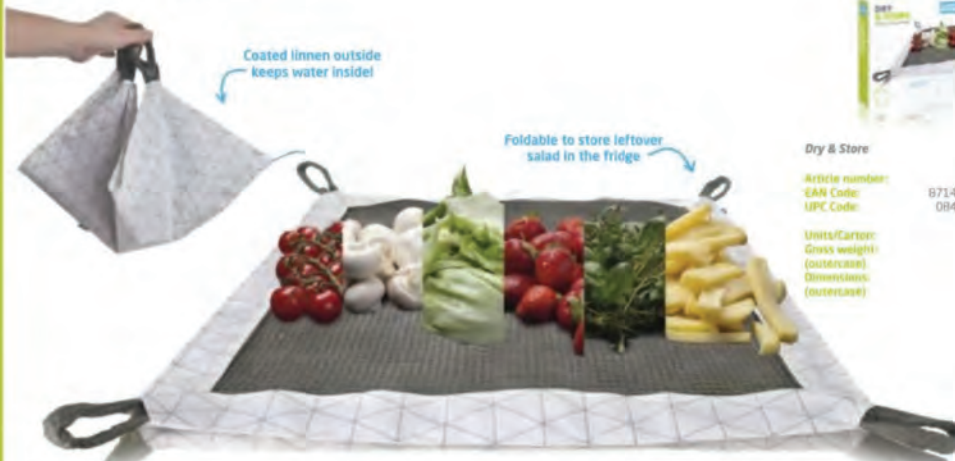

Dry & Store

Article number: 47533606
 EAN Code: 8714793 475335
 UPC Code: 084256 475331

Units/Carbox: 6
 Gross weight: n.a.
 Dimensions: (outer case) n.a.

- EN • Dries your salad greens with a shake or spin
 • Keeps salad fresh in the refrigerator
 • Coated linen keeps water inside
 • Takes up little space
 • Drying cloth is washing machine safe

- NL • Droogt sla door te schudden of te draaien
 • Houdt salade vers in de koelkast
 • Gecoate linnen buitenkant houdt water binnen
 • Neemt weinig ruimte in beslag
 • Theedoek is wasmachinebestendig

- DE • Trocknet Salat und Obst / Gemüse durch schütteln oder schwingen
 • Hält Obst und Gemüse im Kühlschrank frisch
 • Beschichtetes Leinen hält das Wasser innen
 • Nimmt wenig Platz in Anspruch
 • Tuch Waschmaschinenfest

DUE TO THE COATED LINEN OUTSIDE YOU CREATE A MICRO ENVIRONMENT IN WHICH YOUR SALAD GREENS CAN BE STORED

TOMORROW'S KITCHEN

**NO MORE LOST NUTRITION
OR FLAVOR WITH THE
SINGLE SERVE STEAMER**

**TOMORROW'S
KITCHEN**



SINGLE SERVE STEAMER
HEALTHY VEGETABLE STEAMER



Single Serve Steamer

Article number: 29606606
EAN Code: 8714793 296060
UPC Code: 084256 296066

Units/ Carton: 5
Gross weight: n.a.
(outer case)
Dimensions: n.a.
(outer case)

EN No more lost nutrition or flavor with the Single Serve Steamer from Tomorrow's Kitchen. The solid tempered glass bowl is designed to steam a one person dinner or to steam individual portions of vegetables or even meat, fish and poultry. Its shape allows combining four steaming bowls together in standard size microwaves. The smart lid allows you to take the bowl from the microwave despite the glass being hot. Simply drain the remaining water by lifting the lid into draining position. A timesaver that steams your ingredients in no-time!

NL Vitamines en smaak gaan niet langer verloren met de Single Serve Steamer van Tomorrow's Kitchen. De stevig gehard glazen schaal is ontworpen om een enkele maaltijd te stomen of om individuele porties groentes, vlees, vis en gevogelte te stomen. De vorm maakt het mogelijk om vier stoomschaltjes te combineren in de meest gebruikte magnetrons. De slimme deksel zorgt ervoor dat, ondanks de warmte van het glas, de schaal veilig uit de magnetron kan worden genomen. Giet het overgebleven water gemakkelijk af door de deksel in vergietstand te zetten. Bespaart tijd en stoomt je ingrediënten in no-time, ideaal voor een drukke en gezonde levensstijl!

DE Keine verlorenen Nährstoffe oder Geschmack mehr mit dem Single-Dampfgarer von Tomorrow's Kitchen. Die solide temperaturbeständige Glasschüssel ist für das portionsweise Garen oder Fleisch, Fisch, Geflügel und Gemüse entwickelt worden. Durch die Schüsselform finden bis zu 4 Dampfgarer in einer Standardmikrowelle platz. Der speziell entwickelte Deckel sorgt für müheloses und verletzungs-freies Entnehmen der heißen Schüssel aus der Mikrowelle. Das entstandene Kondensat wird einfach durch Anheben des Deckels entfernt. Zeitsparendes Garen und Erhitzen vieler Gemüsesorten.

COOL PLATE

KEEPS YOUR FOOD FRESH



Cool Plate

Article number:	3548360
EAN Code:	8714793 354838
UPC Code:	084256 354834
Units/ Carton:	3
Gross weight:	8,40 kg
(outercase)	18,53 lbs
Dimensions:	40,1 x 32,6 x 35,9 cm
(outercase)	15,79 x 12,83 x 14,13 inch

EN The Cool Plate consists of a base, transparent cover and stainless steel plate. A cooling element is incorporated, providing the ideal solution to keep meat, fish or poultry chilled. Simply keep the cooling element in the freezer and place under the stainless steel plate before use! The transparent cover makes it perfect for picnics and barbecues. Also ideal for salads, cheese, hors d'oeuvres, cake and sushi.

NL De Cool Plate bestaat uit een schaal, een transparante deksel en een RVS plaat. Het bijgeleverde koelelement is de perfecte oplossing om vlees, vis en gevogelte koel te houden. De werking is eenvoudig. Bewaar het koelelement in de vriezer en leg het voor gebruik onder de RVS plaat. De transparante kap maakt het geheel uitermate geschikt voor picknicks en barbecues. Ook ideaal voor salades, kaas, hapjes, taart en sushi.

DE Der Cool Plate besteht aus einem Unterteil, einem durchsichtigen Deckel und einer Platte aus rostfreiem Edelstahl. Ein Kühlelement ist integriert und bietet die ideale Lösung, um Fleisch, Fisch oder Geflügel kühl zu halten. Bewahren Sie das Kühlelement im Gefrierfach auf und legen Sie es vor Gebrauch unter die Edelstahlplatte. Der durchsichtige Deckel macht es zur perfekten Ergänzung für Picknicks und Grillpartys. Auch ideal für Salate, Käse, Vorspeisen, Kuchen und Sushi.



QUICK SKEWER XL

SAFE AND FUN SKEWERING



EN • Quick and easy skewer threading
 • Ideal for meat, fish, fruit, vegetables and marshmallows
 • Easily remove food from skewer

NL • Makkelijk en snel splezen rijgen
 • Ideaal voor vlees, vis, groente, fruit en zacht snoepgoed
 • Gemakkelijk voedsel van spies verwijderen

DE • Schnelles und einfaches Aufspießen
 • Ideal für Fleisch, Fisch, Früchte, Gemüse und Marshmallows
 • Einfaches Entfernen des Inhaltes

Quick Skewer XL

Article number:	5571160
EAN Code:	8714793 557116
UPC Code:	084256 557112
Units/ Carton:	6
Gross weight:	0,89 kg
(outercase)	1,93 lbs
Dimensions:	31 x 18,8 x 19,7 cm
(outercase)	12,2 x 7,4 x 7,76 inch





INSTANT MARINATER
MARINATES AND TENDERIZES IN MINUTES



Instant Marinater Medium
2.3 L/44 fl. oz (incl. pump)

Article number:	2976460
EAN Code:	8714793 297647
UPC Code:	084256 297643
Units/ Carton:	6
Gross weight:	3.99 kg
(outer case)	8.79 lbs
Dimensions:	45.7 x 39.5 x 19.4 cm
(outer case)	17.99 x 15.55 x 7.64 inch



INSTANT MARINATER
MARINATES AND TENDERIZES IN MINUTES



Instant Marinater Large
2.5 L/85 fl. oz (incl. pump)

Article number:	2977460
EAN Code:	8714793 297746
UPC Code:	084256 297742
Units/ Carton:	6
Gross weight:	7.00 kg
(outer case)	15.42 lbs
Dimensions:	55.1 x 37.1 x 28.5 cm
(outer case)	21.69 x 14.61 x 11.22 inch



EN The Instant Marinater is a unique dish that marinates and tenderizes meat, fish, chicken and vegetables in just minutes. It works by creating a vacuum which opens up the pores and fibers of the meat allowing for a deep and instant marinade! This process also tenderizes the food. Marinating foods adds delicious flavors.

NL De Instant Marinater is een uniek concept dat uw vlees, kip, of groente sneller marineert en malser maakt. De werking is gebaseerd op het creëren van vacuüm, waardoor de poriën van het vlees worden geopend en de marinade sneller opgenomen wordt. Als gevolg van het marinieren worden heerlijke smaken aan uw voedsel toegevoegd.

DE Der Instant Marinater ist ein einmaliges Konzept, das Ihr Fleisch, Huhn oder Gemüse schneller mariniert und zarter macht. Der Effekt beruht auf der Schaffung von Vakuum, wodurch die Poren des Fleisches geöffnet werden und die Marinade rascher aufgenommen wird. Als Folge der Marinierung bekommen Ihre Lebensmittel einen herrlichen Geschmack.

VACUUM STORAGE CONTAINERS



EN When foods, coffee or tea are exposed to the air they quickly deteriorate, affecting taste, flavour and crispness. The large capacity vacuum pump extracts the air from the Vacuum Storage Container, creating a vacuum, which optimises storage conditions.

NL Wanneer voedsel, koffie of thee wordt blootgesteld aan lucht, zal de kwaliteit snel achteruit gaan. Smaak, aroma en versheid van de producten kunnen worden aangetast. De grotere vacuümpomp verwijdert de lucht uit de vacuüm bewaarbus, zodat het gecreëerde vacuüm een optimale bewaarconditie vormt.

DE Wenn Lebensmittel, Kaffee oder Tee der Luft ausgesetzt sind, verschlechtern sie sich schnell und beeinflussen Geschmack, Aroma und Frische. Die Vakuumpumpe mit größerer Kapazität, befördert die Luft aus dem Vakuumbehälter und schafft dadurch ein Vakuum, welches die Lagerbedingungen optimiert.

VACUUM CONTAINER

KEEPS FOOD FRESH LONGER

Vacuum guaranteed design!



Vacuum Container Small
0,65 l/23 fl. oz

Article number: 28713606
EAN Code: 8714793 287136
UPC Code: 094256 287132

Units/Cartron: 6
Gross weight: 1,85 kg
(outercase): 4,08 lbs
Dimensions: 40,8 x 27,8 x 11,5 cm
(outercase): 16,06 x 10,94 x 4,53 inch



VACUUM CONTAINER

VACUUM GUARANTEED DESIGN

Suitable for 'air sensitive' foods!



Vacuum Container Medium
1,3 l/44 fl. oz

Article number: 28733606
EAN Code: 8714793 287334
UPC Code: 094256 287330

Units/Cartron: 6
Gross weight: 2,40 kg
(outercase): 5,29 lbs
Dimensions: 40,8 x 27,8 x 19,3 cm
(outercase): 16,06 x 10,94 x 7,2 inch



VACUUM PUMP

USE IN COMBINATION WITH VACUUM CONTAINERS



Vacuum Pump

Article number: 28893606
 EAN Code: 8714793 288935
 UPC Code: 084256 288931

Units/ Carton: 6
 Gross weight: 0.93 kg
 (outer case) 2.06 lbs
 Dimensions: 37 x 10.6 x 16.1 cm
 (outer case) 14.57 x 4.17 x 6.34 inch



IDEAL FOR 'AIR SENSITIVE' FOODS, SUCH AS BISCUITS, CRISPS, NUTS, CEREALS AND TEA OR COFFEE

TOMORROW'S KITCHEN

VACUUM CONTAINER

SUITABLE FOR 'AIR SENSITIVE' FOODS



Vacuum Container Large
 2.3 L/78 fl. oz

Article number: 28743606
 EAN Code: 8714793 287433
 UPC Code: 084256 287433

Units/ Carton: 6
 Gross weight: 3.10 kg
 (outer case) 6.83 lbs
 Dimensions: 40.8 x 27.8 x 28 cm
 (outer case) 16.06 x 10.94 x 11.02 inch



VACUUM COFFEE SAVER

KEEPS YOUR COFFEE FLAVOR AND AROMAS



Large pump to get the air out quickly!

Vacuum Coffee Saver
 500 gr. / 1.3 L/44 fl. oz (incl. Pump)

Article number: 2883460
 EAN Code: 8714793 288348
 UPC Code: 084256 288344

Units/ Carton: 6
 Gross weight: 3.99 kg
 (outer case) 8.79 lbs
 Dimensions: 45.7 x 39.5 x 19.4 cm
 (outer case) 17.99 x 15.55 x 7.64 inch



POPSOME DISPENSERS



EN The PopSome products are practical dispensers for items such as nuts, candy, rice, sugar, herbs and other food. The brightly colored lid and the patented Oxiloc system are specifically designed to ensure that the bowl remains airtight. If you pull up the flexible lid with a "pop", a useful opening appears which makes it possible to simply dose the contents. The dispenser is also designed to retain items within the bowl should it be knocked over.

NL De PopSome producten zijn handige dispensers voor bijvoorbeeld nootjes, snoepjes, rijst, suiker, kruiden of andere levensmiddelen. De vrolijk gekleurde deksel en het gepatenteerde Oxiloc systeem zijn speciaal ontworpen om het bakje luchtdicht af te kunnen sluiten. Als u de flexibele deksel met een "pop" opentrekt ontstaat er een handige opening waardoor u de inhoud gemakkelijk kunt doseren. Als de dispenser per ongeluk omvalt zal de inhoud er niet snel uitrollen.

DE Der Snack-Spender "PopSome" ist ein praktischer Spender für Snacks wie Nüsse, Reis, Zucker, Kräuter oder andere Lebensmittel. Der farbenfrohe Deckel und das patentierte Oxiloc Schließsystem wurde eigens zur Abdichtung der Schale und Frischhaltung entwickelt. Wenn Sie den flexiblen Deckel mit einem Ruck hochziehen, kann der Inhalt leicht dosiert durch die Öffnung fließen. Die Spender ist auch zum sicheren Aufbewahren gegen Um- oder Herunterfallen entwickelt worden.

POPSOME CANDY & NUTS

AIRTIGHT HYGIENIC DISPENSER

Open freshness with a "POP!"



EN • Available in different colors
 • Hygienic
 • Patented Oxiloc creates airtight seal
 • Practical dispenser

NL • Verkrijgbaar in diverse kleuren
 • Hygiënisch
 • Gepatenteerde Oxiloc creëert luchtdichte afsluiting
 • Handige dispenser

DE • Erhältlich in verschiedenen Farben
 • Hygienisch
 • Patentiertes Oxiloc erzeugt luftdichte Abdeckung
 • Praktischer Spender

PopSome Candy & Nuts
 0,45 l/1,5 fl. oz. Pink

Article number: 2030160
 EAN Code: 8714793 282018
 UPC Code: 084256 282014

Units/Case: 6
 Gross weight: 1,25 kg
 (outer case): 2,75 lbs
 Dimensions: 43,1 x 14,8 x 19,4 cm
 (outer case): 16,97 x 5,83 x 7,64 Inch



POPSOME SUGAR & RICE

AIRTIGHT STORING AND QUICK DISPENSING



PopSome Sugar & Rice
0,60 L/20 fl. oz.

Article number: 2831950
 EAN Code: 8714793 282094
 UPC Code: 084256 282090

Units/Case: 6
 Gross weight: 1,44 kg
 (outer case): 3,17 lbs
 Dimensions: 33,4 x 22,6 x 18,2 cm
 (outer case): 13,15 x 8,90 x 7,17 inch



POPSOME FLAVOR

MAKE, SHAKE & POUR



PopSome Flavor Dressing & Marinade
Shaker 0,60 L/20 fl.oz.

Article number: 2833560
 EAN Code: 8714793 283367
 UPC Code: 084256 283363

Units/Case: 6
 Gross weight: 1,44 kg
 (outer case): 3,17 lbs
 Dimensions: 33,4 x 22,6 x 18,2 cm
 (outer case): 13,15 x 8,90 x 7,17 inch



POPSOME CANDY & NUTS

FUN BRIGHTLY COLORED LIDS



PopSome Candy & Nuts
0,45 L/15 fl. oz. Blue

Article number: 2830760
 EAN Code: 8714793 282001
 UPC Code: 084256 282007

Units/Case: 6
 Gross weight: 1,25 kg
 (outer case): 2,75 lbs
 Dimensions: 43,1 x 14,8 x 19,4 cm
 (outer case): 16,97 x 5,83 x 7,64 inch



POPSOME CANDY & NUTS

OPEN FRESHNESS WITH A "POP"



PopSome Candy & Nuts
0,45 L/15 fl. oz. Purple

Article number: 2830060
 EAN Code: 8714793 282087
 UPC Code: 084256 282083

Units/Case: 6
 Gross weight: 1,25 kg
 (outer case): 2,75 lbs
 Dimensions: 43,1 x 14,8 x 19,4 cm
 (outer case): 16,97 x 5,83 x 7,64 inch



POPSOME TODDLER DISPLAY TREE



Toddler Tree (display only, no contents)

Article number: 2945160
 EAN Code:
 UPC Code:

Units/Case: 1
 Gross weight: 0,33 kg
 (outercase): 0,72 lbs
 Dimensions: 29,6 x 19,6 x 11,4 cm
 (outercase): 11,65 x 7,72 x 4,49 inch

POPSOME TODDLER COUNTER DISPLAY



Toddler Display

Article number: 2945060
 EAN Code: (see Toddler Blue & Pink)
 UPC Code:

Units/Case: 24
 Gross weight: 2,29 kg
 (outercase): 5,04 lbs
 Dimensions: 40,8 x 27,8 x 18,3 cm
 (outercase): 16,06 x 10,94 x 7,2 inch

POPSOME TODDLER BLUE COMPACT, FILL, PACK AND GO!



Toddler Blue

Article number: 28457612
 EAN Code: 8714793 284579
 UPC Code: 084256 284575

Units/Case: 12
 Gross weight: 1,03 kg
 (outercase): 2,26 lbs
 Dimensions: 25 x 17,6 x 17,2 cm
 (outercase): 9,84 x 6,93 x 6,77 inch

POPSOME TODDLER PINK POP, SHAKE AND SNACK



Toddler Pink

Article number: 28451612
 EAN Code: 8714793 284517
 UPC Code: 084256 284513

Units/Case: 12
 Gross weight: 1,03 kg
 (outercase): 2,26 lbs
 Dimensions: 25 x 17,6 x 17,2 cm
 (outercase): 9,84 x 6,93 x 6,77 inch

POPSOME CAKE DECORATING SET

AIRTIGHT STORING AND QUICK DISPENSING



PopSome Cake Decorating Set

Article number: 2844060
 EAN Code: 8714793 284401
 UPC Code: 084256 284407

Units/Carton: 3
 Gross weight: 1.99 kg
 (outercase) 4.38 lbs
 Dimensions: 35,2 x 28,2 x 23,7 cm
 (outercase) 13.86 x 11.1 x 9.33 inch

EN The PopSome Cake Decorating Set is a practical way to store and dispense all kinds of cake decorations. The colored lids and the patented Oxiloc system are specifically designed to ensure that the bowls remain airtight. Your favorite cake decorations can be conveniently stored ready for use, when the lid is popped open you can dispense the contents into your hand or directly over the cake. The set comes with a convenient, specially designed stand, making it possible to stack up to 9 dispensers.

NL De PopSome Cake Decorating Set is een praktische manier om taartdecoraties te bewaren en te doseren. De gekleurde deksels en het gepatenteerde Oxiloc systeem zijn speciaal ontworpen om de bakjes luchtdicht af te kunnen sluiten. Uw favoriete taartdecoraties en specerijen kunnen gemakkelijk worden bewaard, klaar voor gebruik. Wanneer u de flexibele deksel met een pop open trekt kunt u de inhoud gemakkelijk doseren in uw hand of direct over het eten. De set wordt geleverd met een handige standaard die speciaal is ontworpen om tot maximaal 9 dispensers te stapelen.

DE Das PopSome Kuchen-Deko-Set ist die ideale Lösung zum Aufbewahren und Portionieren aller Kuchendekorationen. Die farbigen Deckel und vor Allem das patentierte Oxiloc-System sorgen für luftdichtes Verschließen der Behälter. Die favorisierten Dekozutaten werden einfach darin aufbewahrt. Wenn der Deckel hochgezogen wird, kann der Inhalt einfach in die Hand oder direkt auf den Kuchen gestreut werden. Das Set mit dem speziell geformten Halter ist bis zu 9 Stück stapelbar.

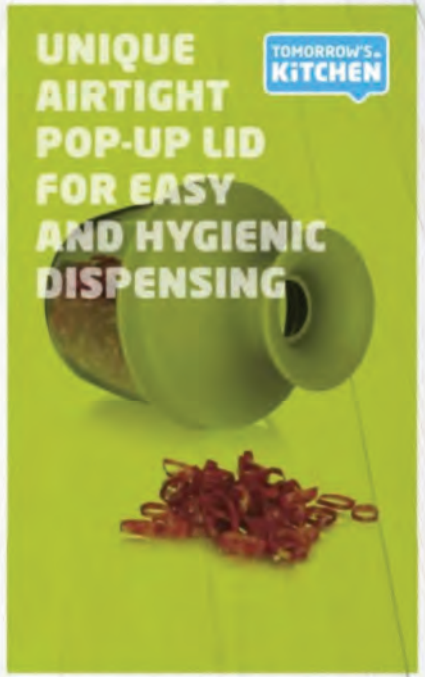

UNIQUE
 AIRTIGHT
 POP-UP LID
 FOR EASY
 AND HYGIENIC
 DISPENSING

TOMORROW'S
 KITCHEN

POPSOME HERBS & SPICES

AIRTIGHT SEAL FOR GUARANTEED FRESHNESS



Stackable!

Open freshness with a "POP!"



PopSome Herbs & Spices Set of 6

Article number: 2043560
 EAN Code: 8714793 284364
 UPC Code: 084256 284360

Units/Carton: 3
 Gross weight: 1.99 kg
 (outercase) 4.38 lbs
 Dimensions: 35,2 x 28,2 x 23,7 cm
 (outercase) 13.86 x 11.1 x 9.33 inch

2-GO PRODUCTS



EN Protect your lunch or fruit when bringing it to work or school with the 2-Go products.

NL Bescherm je lunch of fruit wanneer je deze meeneemt naar school of het werk met de 2-Go producten.

DE Transportschutz für Schule und Beruf mit der 2-Go Serie.

**THE SMART FRUIT
BOXES FROM THE
2-GO PRODUCT RANGE
STIMULATE A HEALTHY
EVERYDAY LIFESTYLE**

**TOMORROW'S
KITCHEN**



BANANA BOX

SUITABLE FOR ALL SIZES

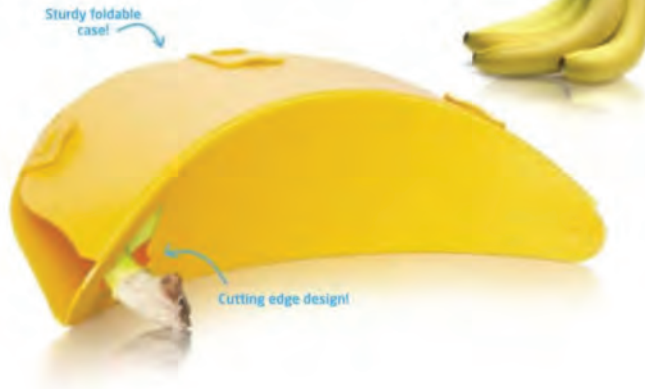

Banana Box

Article number: 28619606
 EAN Code: 8714793 286191
 UPC Code:

Units/ Carton: 6
 Gross weight: 0,55 kg
 (outer case) 1,21 lbs
 Dimensions: 31,3 x 26,3 x 3,8 cm
 (outer case) 12,32 x 10,35 x 1,5 inch

EN A banana is a fragile fruit which can be perfectly preserved in the Banana Box. This practical carry case for bananas of various sizes and curvatures can easily be folded around the banana. The Banana Box has an integrated cutter that allows you to make a shallow cut in the skin to easily open and peel the banana. After use, the Banana Box can be stored completely flat.

NL Een banaan is een kwetsbare vrucht die perfect bewaard blijft in de Banana Box. De handige meeneembox voor bananen in allerlei maten en krommingen kan gemakkelijk om de banaan gevouwen worden. De Banana Box heeft een geïntegreerde snijder waarmee u een kerf in de schil maakt zodat de banaan gemakkelijk gepeld kan worden. Na gebruik kan de Banana Box volledig plat worden opgeborgen.

DE Eine Banane ist eine empfindliche Frucht welche perfekt in dem Bananen-Wächter geschützt ist. Die praktische Transportbox für verschieden große und gebogene Bananen wird einfach um die Banane gefaltet. Der Bananen-Wächter verfügt über ein integriertes Messer und ermöglicht das einfache Einschneiden und Schälen der Banane. Nach Gebrauch kann der Bananen-Wächter vollständig flach aufbewahrt werden.

TOMATO BOX

BRING A HEALTHY BITE



Tomato Box

Article number: 28621606
 EAN Code: 8714793 286214
 UPC Code: 084256 286210

Units/ Carton: 6
 Gross weight: 0,25 kg
 (outer case) 0,54 lbs
 Dimensions: 19,8 x 14,9 x 10,9 cm
 (outer case) 7,8 x 5,87 x 4,29 inch



KIWI BOX

TO PROTECT & SERVE



Kiwi Box

Article number: 2060460
 EAN Code: 8714793 286047
 UPC Code: 084256 286043

Units/ Carton: 6
 Gross weight: 0,51 kg
 (outer case) 1,13 lbs
 Dimensions: 26,6 x 21,10 x 8,90 cm
 (outer case) 10,47 x 8,31 x 3,50 inch





CITRUS CARAFE JUICER & SQUEEZER

PRESS, SQUEEZE AND SERVE - ALL IN ONE



Citrus Carafe Juicer & Squeezer

Article number: 4760260
 EAN Code: 8714793 476028
 UPC Code: 084256 476024

Units/Cartron: 6
 Gross weight: 2,56 kg
 (outer case) 5,64 lbs
 Dimensions: 33,8 x 22,9 x 32,2 cm
 (outer case) 13,31 x 9,02 x 12,68 inch



ACTIVE COOLING CARAFE

CHILLS DRINKS WITHOUT ICE!



Active Cooling Carafe

Article number: 3645260
 EAN Code: 8714793 364523
 UPC Code: 084256 364529

Units/Cartron: 6
 Gross weight: 8,56 kg
 (outer case) 18,87 lbs
 Dimensions: 47 x 31,5 x 31,8 cm
 (outer case) 18,5 x 12,4 x 12,52 inch

- EN • Chills without ice
- Keep cooling elements in freezer
 - Suitable for a variety of drinks
 - Chills drinks in 5 minutes
 - 1 liter capacity

- NL • Koelt, zonder ijs
- Bewaar koelelement in de vriezer
 - Geschikt voor diverse drankjes
 - Drank binnen 5 minuten koel
 - 1 liter inhoud

- DE • Kühlt ohne Eis
- Kühlelemente im Gefrierfach aufbewahren
 - Für eine Vielzahl von Getränken geeignet
 - Kühlt nach 5 Minuten Getränke
 - 1 Liter Kapazität

EASILY STACKABLE TRAYS USING LIMITED SPACE IN YOUR KITCHEN CABINETS

TOMORROW'S KITCHEN



SERVE & STACK
PARTY NESTING BOWLS

6 trays of different sizes!



Serve & Stack Set of 6

Article number: 2850360
 EAN Code: 8714793 285033
 UPC Code: 084256 285039

Units/Carton: 4
 Gross weight: 2,24 kg
 (outercase) 4,93 lbs
 Dimensions: 37,3 x 31,6 x 1,2 cm
 (outercase) 14,69 x 12,44 x 4,72 inch



BREAD & DIP
SERVING SOLUTION!

One bowl holds bread, oils, cutting board and cover!



Bamboo board doubles as a cover!



Bread & Dip

Article number: 2710260
 EAN Code: 8714793 271029
 UPC Code: 084256 271025

Units/Carton: 3
 Gross weight: 3,95 kg
 (outercase) 8,71 lbs
 Dimensions: 34,2 x 26 x 26,2 cm
 (outercase) 13,46 x 10,24 x 10,31 inch

- EN • Suitable for all kinds of bread and dips
- Serving bread in style
 - Bamboo cutting board
 - Bread and dips usefully together
 - Cutting board can be used as a cover

- NL • Geschikt voor alle soorten brood en dips
- Brood serveren in stijl
 - Bamboe snijplank
 - Brood en dips handig bij elkaar
 - Snijplank te gebruiken als deksel

- DE • Passend für alle Arten von Brot und Dips
- Brot servieren mit Stil
 - Bambus Schneidebrett
 - Brot und Dip sind nützlich zusammen
 - Schneidebrett kann als Abdeckung genutzt werden



EGG PILLOW
BRINGS COLOR TO YOUR BREAKFAST TABLE



Comfortable hangout for any egg!

Egg Pillow Set of 4

Article number: 18310606
 EAN Code: 8714793 183100
 UPC Code: 084256 183106
 Units/ Carton: 6
 Gross weight: 1.40 kg
 (outer case) 3.09 lbs
 Dimensions: 26.6 x 21.1 x 8.9 cm
 (outer case) 10.47 x 8.31 x 3.5 inch



UTENSIL REST
KEEPS YOUR COUNTERTOP CLEAN



Utensil rest

Article number: 46706606
 EAN Code: 8714793 476066
 UPC Code: 084256 476062
 Units/ Carton: 6
 Gross weight: n.a.
 (outer case)
 Dimensions: n.a.
 (outer case)

EN Keep your countertop clean during cooking with the Utensil Rest. This smart kitchen help is made from non-slip silicone and is designed to let your utensils rest during cooking without having to clean your countertop. The large notches offer place for up to four cooking utensils and are also suitable to keep your spring tongs in place. The raised edges prevent cooking fluid from leaking onto your countertop.

NL Houd je aanrecht schoon tijdens het koken met behulp van de Utensil Rest. Deze slimme keukenhulp is gemaakt van een antislip siliconen en is ontworpen om je kookgerei gedurende het koken te ondersteunen zonder dat het aanrecht schoon gemaakt hoeft te worden. De grote inkepingen bieden ruimte aan vier verschillende kookgerei en houden tevens een geveerde keukentang op zijn plaats. De opgezette randen zorgen ervoor dat kookvloeistoffen niet op het aanrecht lekken.

DE Halten Sie Ihre Arbeitsplatte mit der Utensil-Ablage sauber. Dieser kleine Küchenhelfer ist aus rutschfestem Silikon hergestellt und so entwickelt, dass er die perfekte Ablage für Küchenhelfer darstellt ohne die Arbeitsplatte zu verschmutzen. Die großen Kerben schaffen Platz für bis zu vier Küchenhelfern und halten ebenfalls Küchenzangen zusammen. Durch den erhöhten Rand bleiben Flüssigkeiten auf der Ablage und laufen nicht auf die Arbeitsfläche.



FOLDABLE TRIVET

TAKES UP LITTLE SPACE



Foldable Trivet

Article number: 1851460
 EAN Code: 8714793 185142
 UPC Code: 084256 185148

Units/ Carton: 6
 Gross weight: 0.59 kg
 (outer case) 1.30 lbs
 Dimensions: 22,6 x 15,7 x 7,6 cm
 (outer case) 8,9 x 6,18 x 2,99 inch



TRIVET RINGS

CLICK TOGETHER



Trivet Rings Set of 6

Article number: 1952060
 EAN Code: 8714793 195202
 UPC Code: 084256 195208

Units/ Carton: 6
 Gross weight: 0.65 kg
 (outer case) 1.43 lbs
 Dimensions: 19,1 x 11,4 x 11,2 cm
 (outer case) 7,52 x 4,49 x 4,41 inch

EN With the Trivet Rings you can support every pan or dish, no matter what size. Place the rings in any pattern to support your pan or dish. After use, the rings can simply be clicked into each other taking up little space.

- Heat resistant up to 230° Celsius/450° Fahrenheit
- Takes up little space
- Suitable for different size pan or dish
- Clicks together for easy storage

NL Met de Trivet Rings kan iedere pan of schotel worden ondersteund, ongeacht de afmeting. Plaats de ringen in iedere willekeurig patroon om je pan of schotel te ondersteunen. Na gebruik kunnen de ringen gemakkelijk in elkaar worden geklikt, waardoor ze weinig ruimte in beslag nemen.

- Hittebestendig tot 230 graden Celsius
- Neemt weinig ruimte in beslag
- Geschikt voor verschillende maten pan of schotel
- Klikt in elkaar voor gemakkelijk opbergen

DE Die Untersetzer-Ringe werden für jede Pfanne oder Topf, egal welche Größe, verwendet. Die Untersetzer können in jeder beliebigen Weise unter der Pfanne oder dem Topf platziert werden. Nach Gebrauch einfach zusammenstecken und dadurch platzsparend aufbewahren.

- Hitzebeständig bis zu 230 Grad Celsius
- Benötigt wenig Platz
- Passend für verschiedene Pfannen- und Topfdurchmesser
- Einfache Aufbewahrung durch Einrasten

+TOOLS



EN The +Tools are the innovative solution in the world of kitchen tools. These well designed kitchen tools are a real asset to every kitchen. The +Tools range contains ten products which are a combination of food preparation tools that are bound up with cooking. Every product has an additional (+) tool in the handle. The extra tool in the handle creates an added value to the main tool and is a perfect assist during cooking. Its color combination gives it a fresh appearance. The +Tools range is the smart solution to avoid full drawers and spending time searching for the right kitchen tool.

NL De +Tools zijn de innovatieve oplossing in de wereld van keukengerei. Deze mooi ontworpen keukengereedschappen zijn een waardevolle aanwinst voor elke keuken. De +Tools serie bevat tien producten die een combinatie zijn van producten voor het bereiden van maaltijden welke onlosmakelijk zijn verbonden met koken. Ieder product heeft een extra +Tool in het handvat. Het extra product in het handvat biedt een extra waarde aan het hoofdproduct en is een perfecte toevoeging tijdens het koken. De +Tools serie is een slimme oplossing om volle lades tegen te gaan en lang zoeken naar het juiste product te voorkomen.

DE Die +Tools sind die innovative Lösung von Küchenhilfen. Diese nett designten Küchenhelfer sind eine wirkliche Bereicherung in jeder Küche. Die +Tools Serie beinhaltet zehn Produkte die für die Zubereitung von Gerichten benötigt werden. Jedes der Artikel verfügt über einen zusätzlichen Küchenhelfer im Griff. Dies sorgt für zusätzlichen Nutzen während des Kochens. Die +Tools Serie ist eine nette Lösung, überfüllte Schubladen zu vermeiden und lange nach dem richtigen Küchenhelfer suchen zu müssen.

PASTA SPOON

+TIMER

MEASURE, TIME AND SCOOP



Pasta Spoon +Timer

Article number:	4668660
EAN Code:	8714793 466869
UPC Code:	084256 466865
Unitz/Carroz:	6
Gross weight:	0,67 kg
(outer case)	1,48 lbs
Dimensions:	38,1 x 10,3 x 14,2 cm
(outer case)	15 x 4,06 x 5,59 inch

EN The Pasta Spoon +Timer is a +Tool designed to measure one portion of spaghetti, time it while it is boiling in the pan and scoop it from the pan when ready. With the help of the digital timer, which is stored in the handle, you can set the correct cooking time necessary for your spaghetti. Measure, time and scoop your spaghetti with this product from the +Tools range.

NL De Pasta Spoon +Timer is een +Tool die speciaal is ontworpen om een portie spaghetti af te meten, het te timen wanneer het kookt en het uiteindelijk uit de pan te halen wanneer het klaar is. Met behulp van de digitale timer, die is opgeborgen in het handvat, kan de juiste tijd worden ingesteld die nodig is voor alle soorten pasta. Afmeten, timen en het uit de pan scheppen van pasta is gemakkelijk met dit product van de +Tools lijn.

DE Der Pastalöffel & Zeitmesser ist ein Produkt aus der 2-in-1-Serie, um eine Spaghettiportion abzumessen und beim Kochen die richtige Garzeit nicht zu verpassen. Mithilfe der im Griff des Pastalöffels integrierten digitalen Uhr wird die richtige Garzeit eingestellt. Kochen und portionieren Sie Ihre Spaghetti mithilfe der richtigen Kochzeitangabe mit diesem 2-in-1-Produkt.

TURNER +TONGS

FLIP AND GRAB



Turner +Tongs

Article number:	4667660
EAN Code:	8714793 466760
UPC Code:	084256 466766
Units/ Carton:	6
Gross weight:	0,64 kg
(outer case)	1,41 lbs
Dimensions:	38,1 x 10,3 x 14,2 cm
(outer case)	15 x 4,06 x 5,59 inch

EN • 2-in-1 design

- Sturdy nylon is perfect for non-stick cookware
- Tongs for grabbing and turning smaller ingredients
- Turner and tongs heat resistant up to 230° Celsius/450° Fahrenheit.

NL • 2-In-1 design

- Stevig nylon is ideaal voor anti-aanbaklaag
- Tang voor oppakken en draaien van kleinere ingrediënten
- Spatelen en tang hittebestendig tot 230 graden

DE • 2-in-1 Design

- Robustes Nylon eignet sich perfekt für Antihftpfannen und Töpfe
- Zange zum Fassen und Umdrehen kleinerer Zutaten
- Pfannenwender und Zange hitzebeständig bis 230 Grad

CHEESE SLICER +RIND PEELER

SLICE AND PEEL



Cheese Slicer +Rind Peeler

Article number:	4654660
EAN Code:	8714793 465466
UPC Code:	084256 465462

Units/ Carton:	6
Gross weight:	0,57 kg
(outer case)	1,27 lbs
Dimensions:	31 x 10,3 x 15 cm
(outer case)	12,2 x 4,06 x 5,91 inch



PEELER +HOLDER

SAFE AND EASY PEEL



Peeler +Holder

Article number:	4660560
EAN Code:	8714793 466067
UPC Code:	084256 466063

Units/ Carton:	6
Gross weight:	0,40 kg
(outer case)	0,88 lbs
Dimensions:	25 x 17,6 x 9,2 cm
(outer case)	9,84 x 6,93 x 3,62 inch



KITCHEN +NUTMEG GRATER

GRATE AND PEEL



Kitchen +Nutmeg Grater

Article number: 4669660
 EAN Code: 8714793 466968
 UPC Code: 084256 466964

Units/Case: 6
 Gross weight: 0.78 kg
 (outer case) 1.72 lbs
 Dimensions: 38.1 x 10.3 x 14.2 cm
 (outer case) 15 x 4.06 x 5.59 inch

EN The Kitchen +Nutmeg Grater is a +Tool designed to grate both hard and soft ingredients, such as chocolate and cheese as well as fine grating ingredients like ginger and nutmeg. The back of the Nutmeg Grater, which is stored in the handle, has a hard rubber pattern which allows you to peel and grind garlic and ginger. Grate all types of ingredients with this product from the +Tools range.

NL De Kitchen +Nutmeg Grater is een +Tool die speciaal ontworpen is om zowel harde als zachte ingrediënten te raspen, als chocolade en kaas, maar ook fijne ingrediënten als gember en nootmuskaat. De achterkant van de nootmuskaatrasp, die is opgeborgen in het handvat, heeft een hard rubber patroon dat ervoor zorgt dat je tevens gemakkelijk de schil van knoflook of gember kunt halen. Rasp alle soorten ingrediënten met dit product van de +Tools lijn.

DE Die Kuchen- +Muskatnuss Reibe ist ein Produkt aus der 2-in-1-Serie, welches harte und weiche Zutaten wie Schokolade und Käse aber auch Muskatnuss und Ingwer reibt. Die Rückseite der Muskatnuss Reibe, welche in dem Griff der Kuchenreibe integriert ist, hat eine geriffelte Oberfläche mit der Ingwer und Knoblauch geschält werden kann. Reiben Sie viele Zutaten mit diesem 2-in-1-Produkt.

CITRUS GRATER +ZESTER

CITRUS TOOL



Citrus Grater +Zester

Article number: 4664660
 EAN Code: 8714793 466463
 UPC Code: 084256 466469

Units/Case: 6
 Gross weight: 0.50 kg
 (outer case) 1.10 lbs
 Dimensions: 31 x 10.3 x 15 cm
 (outer case) 12.2 x 4.06 x 5.91 inch



VEGETABLE KNIFE +BRUSH

VEGGIE PREP



Vegetable Knife +Brush

Article number: 4662660
 EAN Code: 8714793 466265
 UPC Code: 084256 466261

Units/Case: 6
 Gross weight: 0.54 kg
 (outer case) 1.18 lbs
 Dimensions: 31 x 10.3 x 15 cm
 (outer case) 12.2 x 4.06 x 5.91 inch



APPLE CORER +KNIFE CORE AND PEEL



Apple Corer +Knife

Article number: 4663660
EAN Code: 8714793 466364
UPC Code: 084256 466360

Units/Cartron: 6
Gross weight: 0,49 kg
(outercase) 1,07 lbs
Dimensions: 31 x 10,3 x 15 cm
(outercase) 12,2 x 4,06 x 5,91 inch



WHISK +BRUSH PASTRY TOOL



Whisk +Brush

Article number: 4665660
EAN Code: 8714793 466562
UPC Code: 084256 466568

Units/Cartron: 6
Gross weight: 0,58 kg
(outercase) 1,29 lbs
Dimensions: 44,6 x 10,3 x 15,4 cm
(outercase) 17,56 x 4,06 x 6,06 inch



CAKE SERVER +DIVIDER DIVIDE, SLICE AND SERVE



Cake Server +Divider

Article number: 4666660
EAN Code: 8714793 466661
UPC Code: 084256 466667

Units/Cartron: 6
Gross weight: 0,58 kg
(outercase) 1,29 lbs
Dimensions: 37 x 10,6 x 16,1 cm
(outercase) 14,57 x 4,17 x 6,34 inch

EN The Cake Server +Divider is a +Tool designed to divide, cut and serve a cake in no time. Stored in the handle, the divider allows you to divide your cake into 8, 10 or 12 pieces. After choosing the right divider, you can easily cut the cake with the serrated cake server, then use it to serve your cake. Slice and serve your cake easily with this product from the +Tools range.

NL De Cake Server +Divider is een +Tool die speciaal is ontworpen om te verdelen, snijden en te serveren in een handomdraai. In het handvat zitten de verdeleders opgeborgen die u in staat stellen om taart in 8, 10 of 12 stukken te verdelen. Na het kiezen van de juiste verdeleders, snijdt u gemakkelijk een stuk met de gekartelde rand van de Cake Server om hier vervolgens een stuk taart mee te serveren. Snij en serveer uw taart gemakkelijk met dit product uit de +Tools lijn.

DE Der Tortenheber & Einteiler ist ein Produkt aus der 2-in-1-Serie, um Kuchen in kürzester Zeit in gleich große Stücke einzuteilen, zu schneiden und zu servieren. Die Einteiler sind im Griff des Tortenhebers integriert und in drei Größen aufgeteilt: 8, 10 oder 12 Stück Kuchen. Nachdem der richtige Einteiler ausgewählt und in der Mitte des Kuchens platziert wurde, wird mit dem gezackten Messer der Kuchen schnell, sauber und einfach geschnitten. Einfache Handhabung mit diesem 2-in-1-Produkt.

SAVE FOR A FREE TOOL!

Important for Tomorrow's Kitchen is not only to become the brand that sells fun and functional products that bring a smile to the user's face, but also to connect with consumers in order to start a two-way communication.

At the back of each packaging (unique in housewares industry) there is a loyalty stamp. Consumers can choose a free product after collecting points. Our goal is to provide the customer with a free product after purchasing 5 products or more!

More information about this unique saving system is available at tomorrows.kitchen.



Closer to a
free tool!

**TOMORROW'S KITCHEN'S
LOYALTY PROGRAM
IS DEVELOPED TO GET CONSUMERS
CONNECTED TO THE BRAND.
THIS UNIQUE SAVING SYSTEM
WILL PERSUADE CONSUMERS
TO BUY MORE PRODUCTS
AND/OR TO EXCHANGE POINTS
WITH THEIR FAMILY & FRIENDS**

TOMORROW'S
KITCHEN



**A LOGO SHAPED AS
A CONVERSATION BALLOON
SHOWS THAT WE WANT TO
START THE CONVERSATION
WITH OUR CONSUMERS.
WITH A 'DOT' BEHIND
TOMORROW'S THE LOGO
REFERS DIRECTLY TO OUR URL**



**TOMORROW'S
KITCHEN**



**PREPARE TO
BE INSPIRED**



**TOMORROW'S
KITCHEN**

DELICIOUS RECIPES
PRODUCT MOVIES
LOYALTY PROGRAM

& MORE

WWW.TOMORROWS.KITCHEN

CONTACT INFORMATION

 **INTERNATIONAL INNOVATION COMPANY
NETHERLANDS**

Groothandelsweg 1
2645 EH
Delfgauw
The Netherlands

T: +31(0)15 2626926
F: +31(0)15 2568875
E: info@iic.nl
W: www.iic.nl

 **INTERNATIONAL INNOVATION COMPANY
DEUTSCHLAND**

Business Center Ruhrallee 9a
45525
Hattingen
DE Germany

T: +49 2324 68676 0
F: +49 2324 68676-79
info.de@iicbrands.com

 **INTERNATIONAL INNOVATION COMPANY
SPAIN**

Carretera Onda a Villarreal, Km 6
12200
Onda (Castellón)
Spain

T: +34 964 62 68 68
F: +34 964 62 69 69
E: info.es@iicbrands.com

 **INTERNATIONAL INNOVATION COMPANY
FRANCE**

130, boulevard de la Liberté
F - 59000
Lille
France

T: +33 3 20306367
F: +33 3 20306388
E: info.fr@iicbrands.com

 **INTERNATIONAL INNOVATION COMPANY
USA**

1009 Forsyth Avenue, Suite C
NC 28079
Indian Trail
US United States

T: +1 704 8823521
F: +1 704 8824048
E: info.us@iicbrands.com

 **INTERNATIONAL INNOVATION COMPANY
UK**

Unit 341/5, Rushock Trading Estate
Droitwich
Worcestershire
WR9 0NR
United Kingdom

T: +44 1299 250 480
F: +44 1299 251 559
E: Info.uk@iicbrands.com

 **INTERNATIONAL INNOVATION COMPANY
CANADA**

Tsawwassen
CA Canada

T: +1 866 274 9009
F: +1 704 882 4048
E: info.ca@iicbrands.com

**EVERY YEAR
MANY NEW
PRACTICAL
PRODUCTS
ARE INVENTED
BY OUR
IN-HOUSE
DESIGN TEAM**

**BE INSPIRED
WWW.
TOMORROWS.
KITCHEN**

**PRACTICAL
PRODUCTS...
DELICIOUS
RECIPES...
PRODUCT
VIDEOS...
COOKING
TIPS
& MORE
GO TO
WWW.
TOMORROWS.
KITCHEN**





Tomorrow's Kitchen

March 21, 2016 · 🌐



The smart solution that keeps your countertop clean. New from Tomorrow's Kitchen and soon available in stores! The Utensil Rest comes in the colors green and grey.



👍 4

👍 Like

💬 Comment

➦ Share



Write a comment...



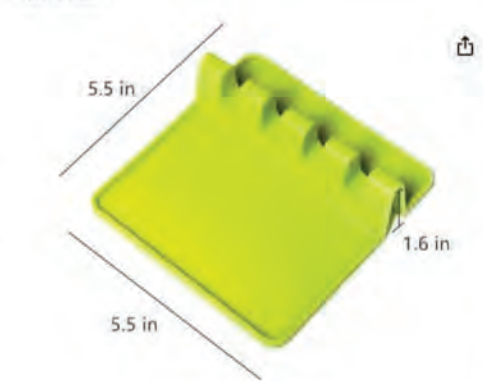

Tomorrows Kitchen (was Vacu Vin 46703606 Kitchen Utensil Tray, Grey

Brand: Tomorrows Kitchen 4.9 ★★★★★ 27 ratings

£7.64
 FREE Returns
 Colour Name: Grey
 Material: Silicone
 Colour: Grey
 Brand: Tomorrows Kitchen
 Item dimensions L x W x H: 10 x 10 x 10 millimetres
 Item weight: 90 Grams

- About this item**
- Keep counters clean and utensils organized with the Utensil Rest by Tomorrow's Kitchen
 - Made of non-slip, heat-safe silicone
 - Four notches hold up to 4 utensils at once
 - Raised edges keep spills on the rest, and not on your surfaces
 - A perfect gift for all the chefs in your life

Free delivery on your first order
 Select the 'Free delivery on first order' option at checkout. See conditions.

Delivery Pickup

£7.64
 FREE Returns
 FREE delivery Tuesday, May 23 on your first order to UK or Ireland. Details

Or fastest delivery **Tomorrow, May 19.** Order within 31 mins. Details

Deliver to London W10 4

Only 11 left in stock

Quantity: 1
 Add to Basket Buy Now

Payment: Secure transaction
 Dispatches from: Amazon
 Sold by: Amazon
 Returns: Returnable within 30 days of receipt

Add gift options
 Add to List

Have one to sell?
 Sell on Amazon

Buy it with



This item: Tomorrows Kitchen (was Vacu Vin 46703606 Kitchen Utensil Tray, Grey) £7.64
Sambonet Rock 52562-81 Stainless Steel Crockery Set for 6 People, 24 Pieces: 6 Forks, 6... £57.77 (€9.63/count)

Total price: **£65.41**
 Add both to Basket

One of these items is dispatched sooner than the other. Show details

Product information

Technical Details

Brand	Tomorrows Kitchen
Model Number	46703606
Colour	Grey
Product Dimensions	1 x 1 x 1 cm; 90 Grams
Material	Silicone
Item Weight	90 g

Additional Information

ASIN	B01CPB3CK6
Customer Reviews	4.9 ★★★★★ 27 ratings 4.9 out of 5 stars
Best Sellers Rank	635,572 in Home & Kitchen (See Top 100 in Home & Kitchen) 566 in Utensil Holders & Organisers
Date First Available	12 Mar. 2016

Feedback

Would you like to **tell us about a lower price?**

Product description

Description:
 Keep counters clean and utensils organized
 Four notches hold up to 4 utensils at once
 Raised edges keep spills on the rest, instead of on the counter surface.
Feature:
 Item: Kitchen Utensil Spatula Holder
 Material: Food Grade Silicone
 Color: Green / Grey
 Size: 14 x 14cm*4cm

Package including
 1 x Kitchen Utensil Spatula Holder

From the brand



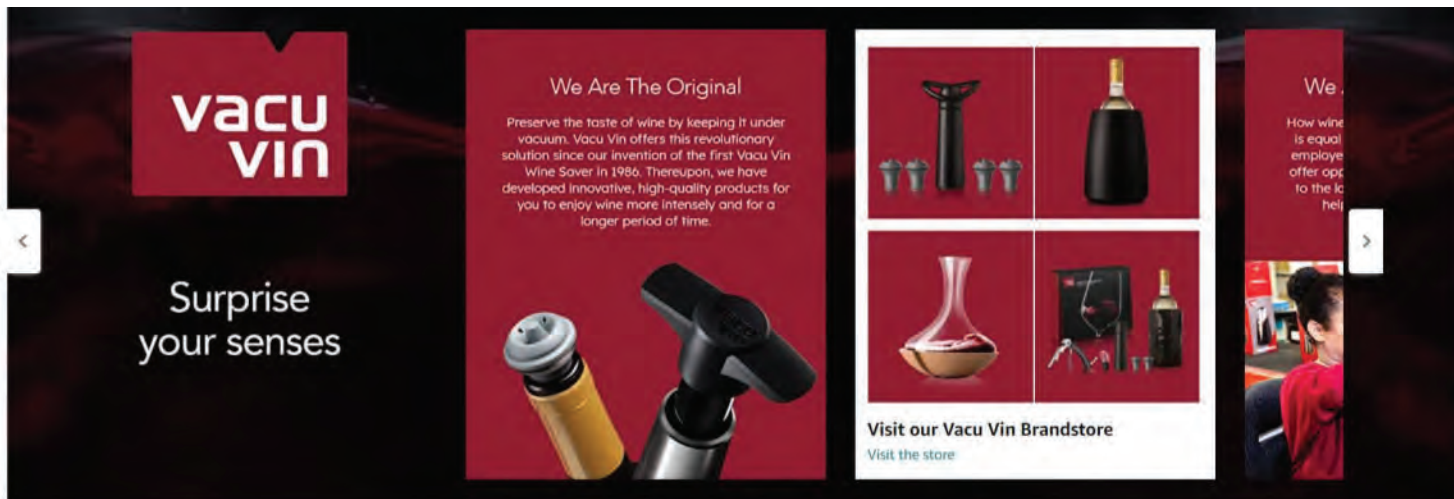

Looking for specific info?

Typical questions asked about products:

- Is the item durable?
- Is this item easy to use?
- What are the dimensions of this item?

Customer reviews

★★★★★ 4.9 out of 5

27 global ratings



How customer reviews and ratings work

Review this product

Share your thoughts with other customers

Write a customer review

Top reviews

Top reviews from United Kingdom

Rodders726

★★★★★ **Just such a simple idea! - we use it all the time!**

Reviewed in the United Kingdom on 19 January 2023

Colour Name: Grey **Verified Purchase**

We first saw, and bought, one of these in Super U, in Tregastel, Brittany in September - so were really pleased when we found them on Amazon's website - bought two for the family! Any mess from utensils, all in one place not scattered all over the worktop! Every home should one!

Helpful Report

R. Lee

★★★★★ **The best designed utensil holder available.**

Reviewed in the United Kingdom on 27 August 2020

Colour Name: Grey **Verified Purchase**

This has to be the best utensil rest I have ever used. It holds several sticky utensils securely, is easy to clean (it's fine in the dishwasher) and still looks good after many months of use. It's sturdy and well made.

Helpful Report

Mel's

★★★★★ **Great utensil rest.**

Reviewed in the United Kingdom on 8 August 2019

Colour Name: Grey **Verified Purchase**

This is a great utensil holder for when your cooking. It's easy to clean and being rubber doesn't move when you take your spoon etc out of the slot.

Helpful Report

Younsook Im

★★★★★ **Must have**

Reviewed in the United Kingdom on 3 August 2020

Colour Name: Grey **Verified Purchase**

Very useful!

Helpful Report

Robert Watkins

★★★★★ **Versatile product**

Reviewed in the United Kingdom on 7 December 2018

Colour Name: Grey **Verified Purchase**

This is the second one we have and is great for small kitchen tops. When not in use on the kitchen top they are useful as a draw tidy.

Helpful Report

See all reviews

Top reviews from other countries

Translate all reviews to English



Silvia

★★★★★ **Fantastico**

Reviewed in Italy on 18 September 2020

Verified Purchase

Questo è un prodotto che mi ha stupito veramente! Utilizzo e lavaggio in lavastoviglie giornaliero ed a distanza di mesi è come nuovo! Utilissimo e comodissimo nella sua semplicità



6 people found this helpful

Report

Translate review to English



Beatrice

★★★★★ **Mai più senza**

Reviewed in Italy on 15 February 2021

Verified Purchase

Comodissimo come poggiamestolo mente si cucina, regge qualsiasi tipo di utensile dal cucchiolo di legno alla schiumarola e raccoglie tutto lo sporco per poi essere comodamente lavato in lavastoviglie. Certo non è bello da vedere come uno di design in ceramica, ma non tornerei mai indietro. Anzi, sto pensando di acquistarne altri per utilizzarli nei cassetti delle posate come suggerito nelle foto. Straconsigliato!

One person found this helpful

Report

Translate review to English



vale

★★★★☆ **Potrebbe essere migliorabile**

Reviewed in Italy on 8 December 2020

Verified Purchase

L'oggetto corrisponde a foto e descrizione del venditore. Invece di usare il solito porta mestoli in ceramica questo consente di appoggiare separatamente i vari attrezzi mentre si cucina. Il silicone mi sembra di buona qualità, inodore e facile da pulire. Quando dico che potrebbe essere migliorabile intendo che un paio di cm in più in lunghezza sarebbero apprezzabili. Consegna Amazon Prime perfetta e puntuale.

2 people found this helpful

Report

Translate review to English



Guido L.

★★★★★ **Toller kleiner Küchenhelfer**

Reviewed in Germany on 19 October 2020

Verified Purchase

Jeder Hobbykoch und jede Hausfrau kennt das: bei den Kochexzessen hat man immer ein paar Löffel, Schöpfer oder Schneebesen rumliegen, die einem die Arbeitsplatte vollsauen. Mit diesem praktischen Unterleg-Pad ist das Problem gelöst. Leicht ist es auch mal verschoben und auf dem Induktionsherd darf es auch mal zwischen den Kochfeldern liegen. Schnell ist es abgewaschen oder hinterher in der Spülmaschine gereinigt. Für mich einfach wunderbar!

Sicher auch ein schönes Mitbringsel: Keiner hat's und jeder kann's gebrauchen.

One person found this helpful

Report

Translate review to English



Ella

★★★★★ **Tolle Idee**

Reviewed in Germany on 24 July 2017

Verified Purchase

Die Silikonmatte hat Platz für 4 Küchenhelfer. Sie ist sehr leicht zu reinigen und absolut rutschfest!

Holzkochlöffel und kleinere Küchenutensilien passen perfekt drauf.... größere leider (jedenfalls bei mir) nicht.

Die Matte ist 14 x 14 cm.

Wenn man den Kochlöffel, Schneebesen etc.. nun in die Rillen ablegt beträgt die Fläche der vorderen Ablage noch 9 cm.

Für große Schneebesen oder z.B. mein gr. Kochlöffel von Le Creuset.... geht über die 9 cm raus und würde somit die Arbeitsfläche verschmieren.

Auch sind meine Griffe zu dick um in die Rillen zu passen.

Dennoch... bin ich mit dieser Matte zufrieden, kann sie empfehlen und habe sie in Gebrauch.

Man kann sich ja selbst ausmessen wie groß seine eigenen Kochutensilien sind und ob man damit selbst klar kommt.

3 people found this helpful

Report

Translate review to English

See all reviews

Inspired by your browsing history

<p>WORK SHARP & Ken Onion Edition Knife and Tool Belt Kit – WSSAK081113 Blade Grinder Attachment with Assorted Belt Kit – Krii... ★★★★★ 5,679 £24.99 FREE Delivery Only 2 left in stock.</p>	<p>WORK SHARP Unisex Adult Knife Sharpener, Ken Onion Edition Blade Grinding Attachment, Black, Standard ★★★★★ 156 £96.24 Get it 25 – 30 May FREE Delivery</p>	<p>LIHUACHEN Knife Sharpener Electric 1/2 x 12 inch Flexible Sanding Belt Knife and Tool Sharpener Replaceme... ★★★★★ 43 £17.99 Get it as soon as Monday, May 22</p>	<p>WORK SHARP Coarse Belt Kit – WSSA0002703 Knife and Tool Sharpener Belt Kit – Premium Grade Abrasives for Sharpeni... ★★★★★ 277 £22.97 Only 5 left in stock.</p>	<p>Work Sharp Knife & Tool Sharpener Mk.2 110v ★★★★★ 4,682 Save 9% £92.35 £101.66 Lowest price in 30 days Get it 25 – 30 May FREE Delivery</p>	<p>WORK SHARP Guided Field Sharpener – WSGFS221 Knife and Tool Guided Field Sharpener – World's To... ★★★★★ 9,096 £51.85 Get it 25 – 30 May FREE Delivery</p>	<p>BeaverCraft LS2P1 Leather Strop Honing Sharpening Strop Knives Chisel Tools 7cm x 20cm Double-Sided Stroppin... ★★★★★ 5,050 £7.95 Get it as soon as Monday, May 22</p>

See personalised recommendations

Sign in

New customer? Start here.

Back to top

Get to Know Us

- Careers
- About Us
- UK Modern Slavery Statement
- Sustainability
- Amazon Science

Make Money with Us

- Sell on Amazon
- Sell on Amazon Business
- Sell on Amazon Handmade
- Sell on Amazon Launchpad
- Protect and build your brand
- Associates Programme
- Fulfilment by Amazon
- Seller Fulfilled Prime
- Advertise Your Products
- Independently Publish with Us
- Amazon Pay
- Host an Amazon Hub
- See More Make Money with Us

Amazon Payment Methods

- Amazon Platinum Mastercard
- Amazon Classic Mastercard
- Amazon Money Store
- Gift Cards
- Amazon Currency Converter
- Payment Methods Help
- Shop with Points
- Top Up Your Account
- Top Up Your Account in Store

Let Us Help You

- COVID-19 and Amazon
- Track Packages or View Orders
- Delivery Rates & Policies
- Amazon Prime
- Returns & Replacements
- Recycling
- Manage Your Content and Devices
- Amazon Mobile App
- Customer Service
- Accessibility



Australia Brazil Canada China France Germany India Italy Japan Mexico Netherlands Poland Singapore Spain Turkey United Arab Emirates United States

Amazon Music
Stream millions of songs

Audible
Download Audiobooks

Amazon Home Services
Experienced pros
Happiness Guarantee

Amazon Warehouse
Deep Discounts
Open-Box Products

AbeBooks
Books, art & collectables

Book Depository
Books With Free Delivery Worldwide

IMDb
Movies, TV & Celebrities

Amazon Business
Service for business customers

ACX
Audiobook Publishing Made Easy

DPRview
Digital Photography

Kindle Direct Publishing
Indie Digital & Print Publishing Made Easy

Whole Foods Market
We Believe in Real Food

Amazon Web Services
Scalable Cloud Computing Services

Goodreads
Book reviews & recommendations

Shopbop
Designer Fashion Brands

Home & Kitchen › Kitchen & Dining › Dining & Entertaining › Flatware › Chopstick & Cutlery Rests › Spoon Rests

Tomorrow's Kitchen Silicone Utensil Rest, Grey (46703606)



Roll over image to zoom in



Roll over image to zoom in



Brand: Tomorrow's Kitchen
4.7 ★★★★★ 6,532 ratings

Color: **Gray**
Material: Silicone
Color: Gray
Brand: Vacu Vin soley
Item Dimensions LxWxH: 5.5 x 1.6 x 5.5 inches
Pattern: Solid

About this item

- Keep counters clean and utensils organized with the Utensil Rest by Tomorrow's Kitchen (Formerly Vacu Vin)
- Made of non-slip, heat-safe silicone
- Four notches hold up to 4 utensils at once, including spring tongs
- Raised edges keep spills on the rest, and not on your surfaces
- A perfect gift for all the chefs in your life

Customer ratings by feature

Versatility ★★★★★ 5.0
Durability ★★★★★ 4.9
Easy to use ★★★★★ 4.8
Raised edges keep spills on the rest, and not on your surfaces

- A perfect gift for all the chefs in your life

Customer ratings by feature

Versatility ★★★★★ 5.0
Durability ★★★★★ 4.9
Easy to use ★★★★★ 4.8
Easy to clean ★★★★★ 4.8

See all reviews

Report incorrect product information.

Deliver to Timothy - Salt Lake... 84111

See All Buying Options

Add to List

Have one to sell?
Sell on Amazon

From the manufacturer

Vacu Vin Silicone Utensil Rest, Gray

The Vacu Vin Utensil Rest is a smart kitchen help made of non-slip silicone. It helps you keep your kitchen organized and clean during cooking. Place your dirty kitchen tools in the holes to prevent them from leaking on your counter top.



- Dishwasher safe
- Large design holds any size utensil
- Multiple notches for multiple utensils
- Non-slip even on slick surfaces
- Keeps spring tongs in place

Compare with similar items



This item Tomorrow's Kitchen Silicone Utensil Rest, Grey (46703606)



Zulay Kitchen Silicone Utensil Rest with Drip Pad for Multiple Utensils - Heat-Resistant Spoon Rest & Spoon Holder for Stove Top - Multi-Functional Kitchen Utensil Holder - Kitchen Accessories (Gray)



Simple Craft Silicone Utensil Rest with Drip Pad for Multiple Utensils - Heat-Resistant, Spoon Rest & Spoon Holder for Stove Top, Kitchen Utensil Holder for Spoons, Ladies, Tongs (Black)



Dip Clip Bowl Plate Holder -8pcs Color Plastic Dish Chip And Dip Serving Set For Spice Tomato Sauce Salt Veggie Vinegar Ketchup Chips - Chip Clips Holders Cup Paper Plate Holder Condiment Cups Dipping

	#1 Best Seller	Add to Cart	Add to Cart	Add to Cart
Customer Rating	★★★★☆ (6532)	★★★★☆ (34475)	★★★★☆ (642)	★★★★☆ (3334)
Price	From \$20.18	\$8 ⁹⁹	\$6 ⁹⁹	\$9 ⁹⁹
Shipping	—	FREE Shipping on orders over \$25.00 shipped by Amazon. Details	FREE Shipping on orders over \$25.00 shipped by Amazon. Details	FREE Shipping on orders over \$25.00 shipped by Amazon. Details
Sold By	Available from these sellers	Zulay Deals	Zulay Deals	ieasycan
Color	Gray	Ash Gray	Black	mixed
Material	Silicone	Silicone	Food-Grade, Heat Resistant	Plastic

Product Description

The Tomorrow's Kitchen Utensil Rest keeps your countertops clean and your utensils organized. This smart kitchen helper is made from non-slip silicone and is designed to hold multiple utensils at once. The raised notches offer a place for up to 4 cooking utensils at once and can even hold your spring-tongs in place! The raised edges keep spills contained on the rest, and not on your countertop. Available in green or gray.

Product information

Product Dimensions	5.5 x 1.6 x 5.5 inches
Item Weight	3.52 ounces
Manufacturer	Vacu Vin
ASIN	B01HNZYMSA
Item model number	46703606
Customer Reviews	4.7 ★★★★★ - 6,532 ratings 4.7 out of 5 stars
Best Sellers Rank	#76,943 in Kitchen & Dining (See Top 100 in Kitchen & Dining) #220 in Spoon Rests
Is Discontinued By Manufacturer	No
Date First Available	June 28, 2016

Feedback

Would you like to **tell us about a lower price?** -

Videos

Videos for this product

Videos for related products

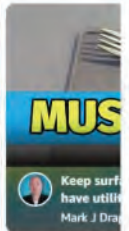
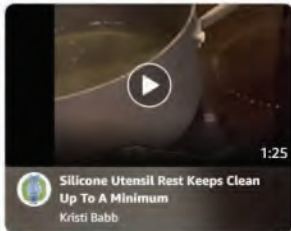

Upload your video

Looking for specific info?

Customer questions & answers

- Question:** What is the difference between the grey/green and limited edition?

Answer: Not sure on the difference however the gray is cool love it
By Laura Warrell on February 18, 2019
~ See more answers (2)
- Question:** What are the dimensions?

Answer: Thanks for your question - the dimensions for this utensil rest are: 5.5 x 5.5 x 1.6 inches
By IIC Brands USA MANUFACTURER on January 4, 2017
~ See more answers (2)
- Question:** So it's a dollar more to get the gray one? What am I missing? They both hold four utensils, right?

Answer: I would say it is the neutral GRAY would be preferable to some than the "lime green" color. SO demand for GRAY - qualifies for \$1 price diff!
By Barb on July 9, 2019
~ See more answers (2)
- Question:** Will it hold a lid? I saw one on FB where you can rest the lid on the "short" side of the holder.

Answer: only in theory, or maybe if its a small lid. Holder should be larger.
By MrQ on December 30, 2019

See more answered questions (16)

Customer reviews

★★★★☆ 4.7 out of 5

6,532 global ratings

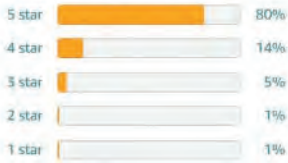

How customer reviews and ratings work

By feature

- Versatility ★★★★★ 5.0
- Durability ★★★★★ 4.9
- Easy to use ★★★★★ 4.8

See more

Review this product

Share your thoughts with other customers

Write a customer review

Reviews with images



See all customer images

Read reviews that mention

- easy to clean
- multiple utensils
- utensil rest
- highly recommend
- dishwasher safe
- works great
- super easy
- cleans easily
- spoons and spatulas
- stove top
- utensil holder
- big enough

Top reviews

Top reviews from the United States

Nancy McKenzie

★★★★★ Nice range addition

Reviewed in the United States us on April 23, 2023

Color: Gray **Verified Purchase**

I like this item. Keeps the cooking utensil I'm using contained which keeps the mess the contained.

Helpful Report

The Spencers

★★★★★ Does what it says!

Reviewed in the United States us on March 3, 2023

Color: Gray **Verified Purchase**

I always used to get a saucer out to hold all the utensils. This is so nice because it holds more utensils than the saucer did, and it keeps them organized so the raw meat fork isn't touching the rest of the utensils. I LOVE IT! I put it on the top rack of the dishwasher, and it comes out perfect every time. I'm thinking about gifting this.....

One person found this helpful

Helpful Report

SPOT

★★★★☆ Is exactly what it says

Reviewed in the United States us on February 16, 2023

Color: Gray **Verified Purchase**

I have been looking for a spoon rest for a couple of years now. This is just exactly what I wanted I just wish it was made of some type of pottery or glass. It is like that silicone stuff so it is great but not the prettiest thing. That being said, it does its' job and is great in every other way!

Helpful Report

Brian H

★★★★★ Great item.

Reviewed in the United States us on March 31, 2023

Color: Gray **Verified Purchase**

use it all the time and it keeps the counter clean.

Helpful Report

EvaMc

★★★★★ 4 years and counting

Reviewed in the United States us on March 19, 2023

Color: Gray **Verified Purchase**

Bought it about 4 years ago. Stays next to my stove and is used on a regular basis. Goes in the dishwasher. No damage yet. Perfect!

Helpful Report

Deborah

★★★★★ 4space spoon rest

Reviewed in the United States us on March 9, 2023

Color: Gray **Verified Purchase**

A 4 place spoon rest, East to clean bends any way you need it to without damage, sturdy and stays put only moves if you need it to

Helpful Report

bargain shopper

★★★★★ Love this!

Reviewed in the United States us on January 26, 2023

Color: Gray **Verified Purchase**

This is easy to clean and use. It holds my utensils well and keeps them off the counter and keeps the counter clean. I can pick it up with my utensil to move to another counter as needed as well. Gifted one to mom at Christmas too.

Helpful Report

sharislater

★★★★☆ **Serves more than 1 pot**

Reviewed in the United States us on December 11, 2022

Color: Gray **Verified Purchase**

Good size for stove. I needed it to hold at least 2 spoons. Good product.

Helpful Report

[See all reviews](#)

Top reviews from other countries

Real_Zenn_Life

★★★★★ **I like this little gadget**

Reviewed in Canada ca on February 22, 2021

Color: Gray **Verified Purchase**

I would recommend this little tray to anyone who needs to use more than one element at a time with a few different spoons or spatulas. It works great and it's easy to clean. I'm very happy.



Report

Kat1950

★★★★★ **What a great gift!**

Reviewed in Canada ca on October 29, 2020

Color: Gray **Verified Purchase**

I bought it for us but think it would make a great stocking stuffer! Compact. Totally love it. My counter remains clean; a nice change when my husband is doing the cooking. Nice to not have to wash off the counter and stove to remove food debris when he cooks.

Report

Jennifer

★★★★★ **Great product**

Reviewed in Canada ca on May 16, 2020

Color: Gray **Verified Purchase**

I just love this in my tiny kitchen. Helps keep my counter cleaner and can just throw this in the sink or top rack of dishwasher.

One person found this helpful

Report

AmazonLaurie Customer

★★★★★ **Works great**

Reviewed in Canada ca on January 1, 2020

Color: Gray **Verified Purchase**

It was a gift for my mom and she absolutely loved it, her husband also was eying it up said it would be good for some of his tools lol

Report

Kay M

★★★★★ **Round 2!**

Reviewed in Canada ca on July 31, 2021

Color: Gray **Verified Purchase**

Previously bought this around Christmas and loved it so much that when we use it so often that washing it everytime we cook seemed to make it slightly difficult. The second one is to swap out when the first when is headed for the wash.

Report

[See all reviews](#)



[Back to top](#)

[Get to Know Us](#)

[Careers](#)

[Make Money with Us](#)

[Sell products on Amazon](#)

[Amazon Payment Products](#)

[Amazon Visa](#)

[Let Us Help You](#)

[Amazon and COVID-19](#)

FREE Shipping on orders over \$25 shipped by Amazon
Climate Pledge Friendly

Best Sellers in Kitchen & Dining

Bounty Quick Size Paper Towels, White, 8 Family Rolls = 20 Regular Rolls (Packaging May Vary),...
★★★★★ 106,524

#1 Best Seller in Paper Towels
\$24.42 (\$2.61/100 Sheets)
Get it as soon as **Wednesday, May 24**
FREE Shipping on orders over \$25 shipped by Amazon

Starbucks K-Cup Coffee Pods—Medium Roast Coffee—Pike Place Ro... Pod · Pike Place
★★★★★ 98,324

#1 Best Seller in Single-Serve Coffee Capsules & Pods
\$55.97 (\$0.58/Count)
Get it as soon as **Wednesday, May 24**
FREE Shipping on orders over \$25 shipped by Amazon

Bounty Quick-Size Paper Towels, White, 16 Family Rolls = 40 Regular Rolls (Packaging May Vary)
★★★★★ 85,389

\$43.15 (\$2.31/100 Sheets)
Get it as soon as **Wednesday, May 24**
FREE Shipping on orders over \$25 shipped by Amazon

Amazon Brand - Prestoflex-a-Size Paper Towels, 158-Sheet Huge Roll, 6 Count (Pack of 2), 12...
★★★★★ 86,642

Amazon's Choice in Paper Towels
\$28.28 (\$1.49/100 Sheets)
Get it as soon as **Wednesday, May 24**
FREE Shipping on orders over \$25 shipped by Amazon

Amazon Brand - Solimo Dark Roast Coffee Pods, Compatible with Keuri... Pods · Dark Roast
★★★★★ 156,529

#1 Best Seller in Climate Pledge Friendly: Grocery
\$29.69 (\$0.30/Count)
Get it as soon as **Wednesday, May 24**
FREE Shipping on orders over \$25 shipped by Amazon

Lavazza Super Crema Whole Bean Coffee Blend, light-Medium... Whole Bean · Super...
★★★★★ 80,692

#1 Best Seller in Ground Coffee
\$22.31 (\$0.63/Ounce)
Get it as soon as **Wednesday, May 24**
FREE Shipping on orders over \$25 shipped by Amazon

Your Browsing History [View or edit your browsing history](#)

PRODUCTS + RECIPES + COMPANY + LOYALTY



1275
Pineapple Slicer & Wedger
 Easily create delicious bite-size chunks!

365
Pineapple Slicer
 In 30 seconds a freshly sliced pineapple!

1103
Citrus Peeler
 Easy peasy peeling!

1084
Strawberry Huller
 Less waste more berry!

364
Melon Slicer
 Slice, scoop and serve!

1714
Fruit Set
 Quickly prepare all of your favorite fruits!

17426
Coconut Opener
 Divide coconut into equal halves

947
Garlic Press
 Scrape the maximum out of your garlic!

1228
Double Mortar & Pestle
 The unpolished interior of the mortar ensures effective grinding

1093
Cheese Grater
 Great - Great - Grater

361
Jar Opener
 Open vacuum seal jars with a gentle lift

360
Cutting Board & Tray
 Counter intelligence!

362
Nut Cracker
 Ergonomically shaped cracker makes for an easy squeeze!

363
Slice & Catch
 No mushroom is safe as the Slice & Catch works easy and can be used by anyone!

359
Cool Plate
 The Cool Plate creates optimal serving conditions outside of your fridge

1589
Quick Skewer XL
 Safe and fun skewering!

1567
Instant Marinater 1.2L
 Marinates and tenderizes in minutes

358
Instant Marinater 2.5L
 With the Instant Marinater you are always prepared for those last-minute barbecues!

1635
Vacuum Coffee Saver 1.2L
 Keeps your coffee flavor and aromas!

357
Vacuum Container (Small - 0.65L)
 Keeps food fresh longer!

356
Vacuum Container (Medium - 1.3L)
 Suitable for air sensitive foods!

355
Vacuum Container (Large - 2.3L)
 Vacuum guaranteed design!

21804
Vacuum Pump Large
 Large pump to get the air out quickly!

1213
PopSome Candy & Nuts
 Unique airtight pop-up lid for easy and hygienic dispensing!

1270
PopSome Sugar & Rice
 Airtight storing and quick dispensing

1570
PopSome Flavor
 Make, shake & pour!

1271
PopSome Herbs & Spices
 Pop for easy access to your herbs and spices in order to add more taste to your favorite dishes

1578
PopSome Cake Decorating Set
 Open decorating fun with a 'POP'!

1274
Banana Box
 Foldable design protects any banana. Cutting edge design!

1682
Tomato Box
 Protects grapes, tomatoes and cherries!

1097
Kiwi Box
 Protects your kiwi from bruising

1272
Citrus Carafe - Juicer & Squeezer
 Press, squeeze and serve - all in one!

353
Active Cooling Carafe
 Active cooling elements keeps drinks cool for hours!

1194
Serve & Stack
 Set the table with this set of nesting bowls

1227
Bread & Dip
 One bowl holds bread, oils, cutting board and cover!

1121
Foldable Trivet
 Takes up little space

1579
Trivet Rings
 Fits under pots & pans and clicks together!

1109
Egg Pillows
 The cutest way to serve your boiled egg!

1587
Pasta Spoon + Timer
 Measure, time and scoop

1582
Turner + Tongs
 Flip and grab

1535
Cheese Slicer + Rind Peeler

1277
Peeler + Holder

1588
Kitchen + Nutmeg Grater

1590
Citrus Grater + Zester

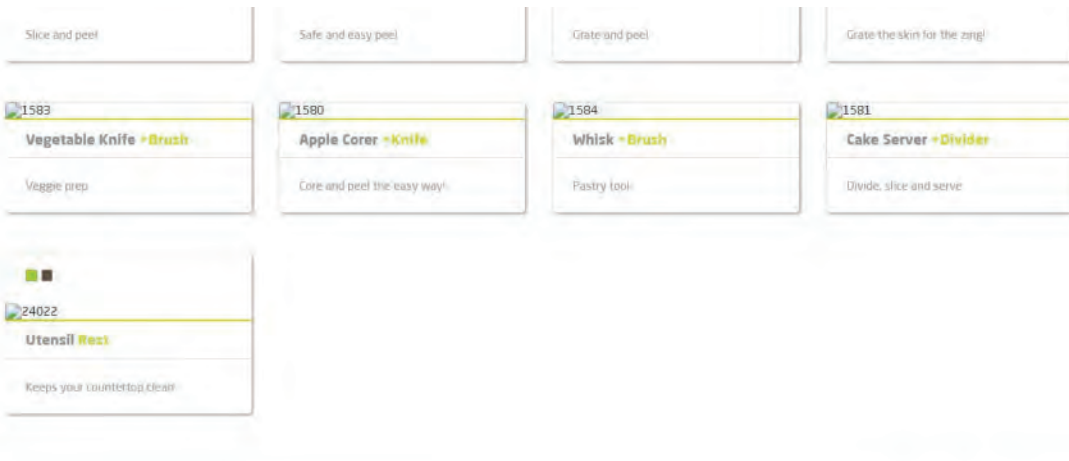

PREPARE < SERVE > STORE >> LOYALTY PROGRAM



Keep your countertop clean during cooking with the Utensil Rest. This smart kitchen help is made from non-slip silicone and is designed to let your utensils rest during cooking without having to clean your countertop. The large notches offer place for up to four cooking utensils and are also suitable to keep your spring tongs in place. The raised edges prevent cooking fluid from leaking onto your countertop.

- Dishwasher safe
- Large design holds any size utensil
- Multiple notches for multiple utensils
- Non-slip even on slick surfaces
- Keeps spring tongs in place

Color



SHARE THE PRODUCT ON



Brochure
Recipes
Company
Offices
Contact



Back to results



Roll over image to zoom in



Tomorrow's Kitchen Silicone Utensil Rest, Grey (46703606)

Brand: Tomorrow's Kitchen
4.7 ★★★★★ 6,563 ratings

Color:	Gray
Material:	Silicone
Color:	Gray
Brand:	Vacu Vin solely
Item Dimensions LxWxH:	5.5 x 1.6 x 5.5 inches
Pattern:	Solid

Select delivery location

See All Buying Options

Add to List

Have one to sell?
Sell on Amazon

About this item

- Keep counters clean and utensils organized with the Utensil Rest by Tomorrow's Kitchen (Formerly Vacu Vin)
- Made of non-slip, heat-safe silicone
- Four notches hold up to 4 utensils at once, including spring tongs
- Raised edges keep spills on the rest, and not on your surfaces
- A perfect gift for all the chefs in your life

Customer ratings by feature

Durability	★★★★★ 4.9
Easy to use	★★★★★ 4.8
Easy to clean	★★★★★ 4.8
Sturdiness	★★★★★ 4.7

See all reviews

Goes well with

Page 1 of 7

<p>ME.FAN Silicone Trivet - Trivet Mat - Kitchen Hot Pads for Pots/Hot Dish Insulated Teapot Trivet... ★★★★★ 4,138 400+ bought in past month \$9.99 Get it as soon as Saturday, Jul 22 FREE Shipping on orders over \$25 shipped by Amazon</p>	<p>Rachael Ray Gadgets Utensil Kitchen Cooking Tools Set, 6 Piece... ★★★★★ 4,288 50+ bought in past month Amazon's Choice Cooking Utensil Sets \$29.99 (\$5.00/Item) Get it as soon as Saturday, Jul 22 FREE Shipping on orders over \$25 shipped by Amazon</p>	<p>M Miaoyan Oven Mitts and Pot Holders 4 pcs Set, High Heat Resistant 500 Degree Extra... ★★★★★ 155 100+ bought in past month \$14.99 (\$1.87/Ounce) Get it as soon as Saturday, Jul 22 FREE Shipping on orders over \$25 shipped by Amazon</p>	<p>Carvapeet Kitchen Mat [2 PCS 17"x48" x 17"x24"] Non-Slip Backing... ★★★★★ 105 100+ bought in past month Amazon's Choice Kitchen Rugs \$25.99 Get it as soon as Saturday, Jul 22 FREE Shipping on orders over \$25 shipped by Amazon Climate Pledge Friendly</p>	<p>Arrozto Salt and Pepper Shakers Set, 4 oz Glass Bottom Salt Pepper... ★★★★★ 4,760 1K+ bought in past month #1 Best Seller in Salt Shakers \$11.99 Get it as soon as Saturday, Jul 22 FREE Shipping on orders over \$25 shipped by Amazon</p>	<p>FUN ELEMENTS Kitchen Utensil Holder, 7.2" Super Large Utensil... ★★★★★ 534 100+ bought in past month Amazon's Choice Utensil Crocks \$24.99 Get it as soon as Saturday, Jul 22 FREE Shipping on orders over \$25 shipped by Amazon</p>	<p>Silicone Dish Scrubber, 7 Pack Silicone Sponge... ★★★★★ 627 100+ bought in past month Save 50% \$5.99 List: \$11.99 Lowest price in 30 days Get it as soon as Saturday, Jul 22 FREE Shipping on orders over \$25 shipped by Amazon</p>
---	---	---	--	---	---	---

Compare with similar items



This item Tomorrow's Kitchen Silicone Utensil Rest, Grey (46703606)	Dip Clip Bowl Plate Holder -8pcs Color Plastic Dish Chip And Dip Serving Set For Spice Tomato Sauce Salt Veggie Vinegar Ketchup Chips - Chip Clips Holders Cup Paper Plate Holder Condiment Cups Dipping	NileHome Silicone Spoon Rest for Kitchen Counter with 6 Slots - Spoon Holder with Drip Pad Heat-Resistant BPA-Free Kitchen Utensil Holder Multiple Spoon Holder for Stove Top Kitchen Utensil Rest	Silicone Utensil Rest with Drip Pad for Multiple Utensils, Heat-Resistant, Spoon Rest & Spoon Holder for Stove Top, Kitchen Utensil Holder for Ladles, Tongs & More - by Zulay (Gardenia)
Add to Cart	Add to Cart	Add to Cart	Add to Cart
Customer Rating	★★★★☆ (6563)	★★★★☆ (3374)	★★★★☆ (3160)
Price	From \$15.55	\$9.99	\$7.99
Shipping	—	FREE Shipping on orders over \$25.00 shipped by Amazon or get Fast, Free Shipping with Amazon Prime	FREE Shipping on orders over \$25.00 shipped by Amazon or get Fast, Free Shipping with Amazon Prime
Sold By	Available from these sellers	ieasycan	Zulay Deals
Color	Gray	mixed	Gardenia
Material	Silicone	Plastic	Silicone

Product Description

The Tomorrow's Kitchen Utensil Rest keeps your countertops clean and your utensils organized. This smart kitchen helper is made from non-slip silicone and is designed to hold multiple utensils at once. The raised notches offer a place for up to 4 cooking utensils at once and can even hold your spring-tongs in place! The raised edges keep spills contained on the rest, and not on your countertop. Available in green or gray.

Product information

Product Dimensions	5.5 x 1.6 x 5.5 inches
Item Weight	3.52 ounces
Manufacturer	Vacu Vin
ASIN	B01HNZYMSA
Item model number	46703606
Customer Reviews	4.7 ★★★★★ - 6,563 ratings 4.7 out of 5 stars
Best Sellers Rank	#49,448 in Kitchen & Dining (See Top 100 in Kitchen & Dining) #150 in Spoon Rests
Is Discontinued By Manufacturer	No
Date First Available	June 28, 2016

Feedback

Would you like to [tell us about a lower price?](#)

Videos

Videos for this product

Videos for related products

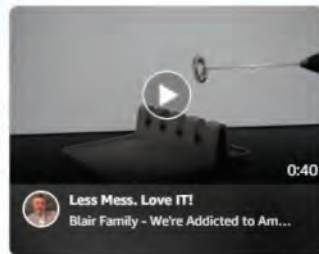
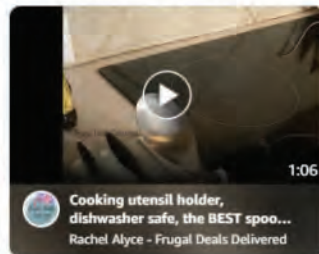

Upload your video

Some kind of test override title

Some kind of test override Some kind of test override link text

Looking for specific info?

Customer questions & answers

- Question:** What is the difference between the grey/green and limited edition?

Answer: Not sure on the difference however the gray is cool love it
By Laura Warrell on February 18, 2019
See more answers (2)

Question: What are the dimensions?
Answer: Thanks for your question - the dimensions for this utensil rest are: 5.5 x 5.5 x 1.6 inches
 By IIC Brands USA MANUFACTURER on January 4, 2017
 ✓ See more answers (2)

Question: So it's a dollar more to get the gray one? What am I missing? They both hold four utensils, right?
Answer: I would say it is the neutral GRAY would be preferable to some than the "lime green" color. SO demand for GRAY - qualifies for \$1 price diff!
 By Barb on July 9, 2019
 ✓ See more answers (2)

Question: Will it hold a lid? I saw one on FB where you can rest the lid on the "short" side of the holder
Answer: only in theory, or maybe if its a small lid. Holder should be larger.
 By MrQ on December 30, 2019

[See more questions](#)

Customer reviews

★★★★☆ 4.7 out of 5

6,563 global ratings

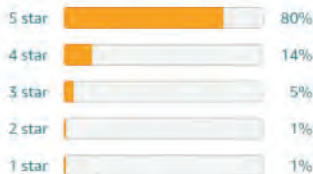

✓ How customer reviews and ratings work

By feature

- Durability ★★★★★ 4.9
- Easy to use ★★★★★ 4.8
- Easy to clean ★★★★★ 4.8

✓ See more

Review this product

Share your thoughts with other customers

Reviews with images



[See all customer images](#)

Read reviews that mention

- easy to clean
- multiple utensils
- utensil rest
- highly recommend
- spoons and spatulas
- dishwasher safe
- works great
- super easy
- cleans easily
- stove top
- big enough
- utensil holder
- much better

Top reviews ▾

Top reviews from the United States

Rhonda
 ★★★★★ **Perfect holder**
 Reviewed in the United States on May 17, 2023
 Color: Gray **Verified Purchase**
 It holds many sizes of spoons, spatulas,etc. Easy to clean and store.
 Helpful Report

SPOT
 ★★★★★ **Is exactly what it says**
 Reviewed in the United States on February 16, 2023
 Color: Gray **Verified Purchase**
 I have been looking for a spoon rest for a couple of years now. This is just exactly what I wanted I just wish it was made of some type of pottery or glass. It is like that silicone stuff so it is great but not the prettiest thing. That being said, it does its' job and is great in every other way!
 Helpful Report

Nancy McKenzie
 ★★★★★ **Nice range addition**
 Reviewed in the United States on April 23, 2023
 Color: Gray **Verified Purchase**
 I like this item. Keeps the cooking utensil I'm using contained which keeps the mess the contained.
 Helpful Report

The Spencers
 ★★★★★ **Does what it says!**
 Reviewed in the United States on March 3, 2023
 Color: Gray **Verified Purchase**
 I always used to get a saucer out to hold all the utensils. This is so nice because it holds more utensils than the saucer did, and it keeps them organized so the raw meat fork isn't touching the rest of the utensils. I LOVE IT! I put it on the top rack of the dishwasher, and it comes out perfect every time. I'm thinking about gifting this.....
 One person found this helpful
 Helpful Report

EvaMc

★★★★★ **4 years and counting**

Reviewed in the United States on March 19, 2023

Color: Gray [Verified Purchase](#)

Bought it about 4 years ago. Stays next to my stove and is used on a regular basis. Goes in the dishwasher. No damage yet. Perfect!

Helpful

Report



Brian H

★★★★★ **Great item.**

Reviewed in the United States on March 31, 2023

Color: Gray [Verified Purchase](#)

use it all the time and it keeps the counter clean.

Helpful

Report



Deborah

★★★★★ **4space spoon test**

Reviewed in the United States on March 9, 2023

Color: Gray [Verified Purchase](#)

A 4 place spoon rest, East to clean bends any way you need it to without damage, sturdy and stays put only moves if you need it to

Helpful

Report



bargain shopper

★★★★★ **Love this!**

Reviewed in the United States on January 26, 2023

Color: Gray [Verified Purchase](#)

This is easy to clean and use. It holds my utensils well and keeps them off the counter and keeps the counter clean. I can pick it up with my utensil to move to another counter as needed as well. Gifted one to mom at Christmas too.

Helpful

Report

[See all reviews >](#)**Top reviews from other countries**[Translate all reviews to English](#)

Ryan D

★★★★★ **Is does it job perfectly**

Reviewed in Australia on March 19, 2020

Color: Gray [Verified Purchase](#)

Excellent product

Report



Noemi Cortes Larios

★★★★★ **Buenísimo**

Reviewed in Mexico on September 4, 2022

Color: Gray [Verified Purchase](#)

Justo lo que esperaba, fácil de lavar y muy funcional.

Report

[Translate review to English](#)

Kay M

★★★★★ **Round 2!**

Reviewed in Canada on July 31, 2021

Color: Gray [Verified Purchase](#)

Previously bought this around Christmas and loved it so much that when we use it so often that washing it everytime we cook seemed to make it slightly difficult. The second one is to swap out when the first when is headed for the wash.

Report



Kat1950

★★★★★ **What a great gift!**

Reviewed in Canada on October 29, 2020

Color: Gray [Verified Purchase](#)

I bought it for us but think it would make a great stocking stuffer! Compact. Totally love it. My counter remains clean; a nice change when my husband is doing the cooking. Nice to not have to wash off the counter and stove to remove food debris when he cooks.

Report



Real_Zenn_Life

★★★★★ **I like this little gadget**

Reviewed in Canada on February 22, 2021

Color: Gray **Verified Purchase**

I would recommend this little tray to anyone who needs to use more than one element at a time with a few different spoons or spatulas. It works great and it's easy to clean. I'm very happy.



Report

[See all reviews >](#)

Customers who bought this item also bought these All-Purpose Household Cleaners



TOPIST Angry Mama Microwave Cleaner
 Angry Mom Microwave...
 ★★★★★ 7,635
 2K+ bought in past month
57% off Deal
\$6.91
 List: ~~\$15.99~~
 Get it as soon as **Saturday, Jul 22**
 FREE Shipping on orders over \$25 shipped by Amazon



GB Quality Angry Mama Microwave Oven Cleaner
 Kitchen Gadget Water...
 ★★★★★ 813
 50+ bought in past month
Amazon's Choice in All-Purpose Household Cleaners
\$6.49 (\$6.49/Count)
 Get it as soon as **Sunday, Jul 23**
 FREE Shipping on orders over \$25 shipped by Amazon



Asltw Angry Mama Microwave Oven Cleaner,
 Fast Action Steam Kitchen Gadget, Just A...
 ★★★★★ 1,246
 50+ bought in past month
\$5.99 (\$5.99/count)
 Get it as soon as **Saturday, Jul 22**
 FREE Shipping on orders over \$25 shipped by Amazon



Asltw Angry Mama Microwave Oven Cleaner,
 Fast Action Steam Kitchen Gadget, Just Add Vinegar and Water (Blue)
 ★★★★★ 1,246
\$5.99 (\$5.99/Count)
 Get it as soon as **Saturday, Jul 22**
 FREE Shipping on orders over \$25 shipped by Amazon



Stardrops - The Pink Stuff - The Miracle All Purpose Cleaning Paste
 ★★★★★ 163,351
 100K+ bought in past month
#1 Best Seller in All-Purpose Household Cleaners
\$5.97 (\$0.34/Ounce)
 Get it as soon as **Saturday, Jul 22**
 FREE Shipping on orders over \$25 shipped by Amazon



Glister Garbage Disposer Cleaner, Odor Eliminator with Foaming Action, Removes Build-up and...
 ★★★★★ 39,629
 30K+ bought in past month
\$3.78 (\$0.77/Ounce)
 Get it as soon as **Saturday, Jul 22**
 FREE Shipping on orders over \$25 shipped by Amazon

Best Sellers in Kitchen & Dining



Bounty Quick Size Paper Towels, White, 8 Family Rolls = 20 Regular Roll...
 ★★★★★ 109,609
 100K+ bought in past month
#1 Best Seller in Paper Towels
\$24.42
 Get it as soon as **Saturday, Jul 22**
 FREE Shipping on orders over \$25 shipped by Amazon



Amazon Brand - Solimo Dark Roast Coffee Pods, Compatible with Keuri...
 ★★★★★ 146,265
 40K+ bought in past month
#1 Best Seller in Climate Pledge Friendly Grocery
\$24.85 (\$0.25/Count)
 Get it as soon as **Saturday, Jul 22**
 FREE Shipping on orders over \$25 shipped by Amazon



Starbucks K-Cup Coffee Pods—Medium Roast Coffee—Pike Place Roast for Keurig Brewers—...
 ★★★★★ 132,231
 20K+ bought in past month
\$49.32 (\$0.51/Count)
 Get it as soon as **Saturday, Jul 22**
 FREE Shipping on orders over \$25 shipped by Amazon



Stanley Quencher H2.0 FlowState Stainless Steel Vacuum Insulated Tumbler with Lid and...
 ★★★★★ 2
#1 Best Seller in Kitchen & Dining
\$45.00
 Get it as soon as **Saturday, Jul 22**
 FREE Shipping on orders over \$25 shipped by Amazon



Amazon Brand - Presto! Flex-a-Size Paper Towels, 158 Sheet Huge Roll, 1...
 ★★★★★ 87,266
 100K+ bought in past month
Amazon's Choice in Paper Towels
\$28.28 (\$1.49/100 Sheets)
 Get it as soon as **Saturday, Jul 22**
 FREE Shipping on orders over \$25 shipped by Amazon



Bounty Quick-Size Paper Towels, White, 16 Family Rolls = 40 Regular Rolls (Packaging May Vary)
 ★★★★★ 88,517
 100K+ bought in past month
\$43.49 (\$2.32/100 Sheets)
 Get it as soon as **Saturday, Jul 22**
 FREE Shipping on orders over \$25 shipped by Amazon

Popular products based on this item



Silicone Utensil Rest by Kasian House - Extra Large Kitchen Spoon Rest with Drip Pad,...
 ★★★★★ 278
 100+ bought in past month
Amazon's Choice in Spoon Rests
\$10.99-\$11.99



KITEXPERT Silicone Spoon Rest for Stove Top & Kitchen Counter - Non-Slip Utensil Rest with Drip Pad for Ladl...
 ★★★★★ 44
 50+ bought in past month
\$7.99-\$9.99



ProTensils Silicone Soap Holder, Utensil Rest, Sponge Holders, Kitchen Organizer, Spoon Storage, Non-Slip - Hygienic Kitchen...
 ★★★★★ 279
\$5.99-\$8.99



Rolin Roly Spoon Holder Epoxy Mould Multiple Utensil Rest Silicone Molds...
 ★★★★★ 5
\$17.97
 Get it as soon as **Saturday, Jul 22**
 FREE Shipping on orders over \$25 shipped by Amazon
 Only 4 left in stock - order...



Utensil Organizer, Silicone Spoon Rest, Kitchen Utensil Holder, Spoon Rest for Stove Top, Spoon and Spatula Holder, Utensil Caddy,...
 ★★★★★ 179
\$5.99-\$6.19



Food Grade Silicone Spoon/Utensil Rest, black
\$4.99
 Get it as soon as **Saturday, Jul 22**
 FREE Shipping on orders over \$25 shipped by Amazon

[See personalized recommendations](#)

Please don't scroll past this. The Internet Archive (which runs the Wayback Machine) is a nonprofit, powered by donations averaging about \$27. Join the one in a thousand users that support us financially—if our resources are useful to you, please pitch in.

Can You Chip In? (USD)

\$5 \$27 \$50 \$100



http://tomorrows.kitchen/22601/Products

6 captures

20 Feb 2016 - 5 Jul 2016

Go

MAY

JUL

AUG

05

2015

2016

2017

About this capture

PRODUCTS RECIPES COMPANY LOYALTY



- 1275 Pineapple Slicer & Wedger**
Easily create delicious bite-size chunks!
- 365 Pineapple Slicer**
In 30 seconds a freshly sliced pineapple!
- 1103 Citrus Peeler**
Easy peasy peeling!
- 1084 Strawberry Huller**
Less waste, more berry!
- 364 Melon Slicer**
Slice, scoop and serve!
- 1714 Fruit Set**
Quickly prepare all of your favorite fruits.
- 17426 Coconut Opener**
Divide coconut into equal halves
- 947 Garlic Press**
Scrape the maximum out of your garlic!
- 1228 Double Mortar & Pestle**
The unpolished interior of the mortar ensures effective grinding
- 1093 Cheese Grater**
Great- Great-Grater
- 361 Jar Opener**
Open vacuum seal jars with a gentle lift
- 360 Cutting Board & Tray**
Counter intelligence!
- 362 Nut Cracker**
Ergonomically shaped cracker makes for an easy squeeze
- 363 Slice & Catch**
No mushroom is safe as the Slice & Catch works easy and can be used by anyone!
- 359 Cool Plate**
The Cool Plate creates optimal serving conditions outside of your fridge
- 1589 Quick Skewer XL**
Safe and fun skewering!
- 1567 Instant Marinater 1.3L**
Marinates and tenderizes in minutes!
- 358 Instant Marinater 2.5L**
With the Instant Marinater you are always prepared for those last-minute barbecues!
- 1635 Vacuum Coffee Saver 1.3L**
Keeps your coffee flavor and aroma!
- 357 Vacuum Container (Small - 0.65L)**
Keeps food fresh longer!
- 356 Vacuum Container (Medium - 1.3L)**
Suitable for 'air sensitive' foods!
- 355 Vacuum Container (Large - 2.3L)**
Vacuum guaranteed design!
- 21804 Vacuum Pump Large**
Large pump to get the air out quickly!
- 1213 PopSome Candy & Nuts**
Unique airtight pop-up lid for easy and hygienic dispensing
- 1270 PopSome Sugar & Rice**
Airtight storing and quick dispensing
- 1570 PopSome Flavor**
Make, shake & pour!
- 1271 PopSome Herbs & Spices**
Pop for easy access to your herbs and spices in order to add more taste to your favorite dishes
- 1578 PopSome Cake Decorating Set**
Open decorating fun with a "POP"!
- 1274 Banana Box**
Foldable design protects any banana. Cutting edge design!
- 1682 Tomato Box**
Protects grapes, tomatoes and cherries!
- 1097 Kiwi Box**
Protects your kiwi from bruising.
- 1272 Citrus Carafe - Juicer & Squeezer**
Press, squeeze and serve - all in one!

1353
Active Cooling Carafe
Active cooling elements keeps drinks cool for hours!

1194
Serve & Stack
Set the table with this set of nesting bowls

1227
Bread & Dip
One bowl: holds bread, oils, cutting board and cover!

1121
Foldable Trivet
Takes up little space

1579
Trivet Rings
Fits under pots & pans and clicks together!

1109
Egg Pillows
The cutest way to serve your boiled egg!

1587
Pasta Spoon +Timer
Measure, time and scoop

1582
Turner + Tongs
Flip and grab

1535
Cheese Slicer + Rind Peeler
Slice and peel

1277
Peeler +Holder
Safe and easy peel

1588
Kitchen +Nutmeg Grater
Grate and peel

1590
Citrus Grater +Zester
Grate the skin for the zing!

1583
Vegetable Knife +Brush
Veggie prep

1580
Apple Corer +Knife
Core and peel the easy way!

1584
Whisk +Brush
Pastry tool

1581
Cake Server +Divider
Divide, slice and serve

24022
Utensil Rest
Keeps your countertop clean

DocCode - PATENT.GRANT

SCORE Placeholder Sheet for IFW Content

Application Number: 29625265

Document Date: 12/15/2020

The presence of this form in the IFW record indicates that the following document type was received in electronic format on the date identified above. This content is stored in the SCORE database.

Since this was an electronic submission, there is no physical artifact folder, no artifact folder is recorded in PALM, and no paper documents or physical media exist. The TIFF images in the IFW record were created from the original documents that are stored in SCORE.

- Patent Grant with Color/Grayscale Drawings

At the time of document entry (noted above):

- USPTO employees may access SCORE content via DAV or via the SCORE web page.
- External customers may access SCORE content via PAIR using the Supplemental Content tab.



UNITED STATES PATENT AND TRADEMARK OFFICE

UNITED STATES DEPARTMENT OF COMMERCE
 United States Patent and Trademark Office
 Address: COMMISSIONER FOR PATENTS
 P.O. Box 1450
 Alexandria, Virginia 22313-1450
www.uspto.gov

APPLICATION NO.	ISSUE DATE	PATENT NO.	ATTORNEY DOCKET NO.	CONFIRMATION NO.
29/625,265	12/15/2020	D904832	VVI.001USP	5612

155876 7590 11/24/2020
 Peretz Chesal & Herrmann, P.L.
 2 S. Biscayne Blvd., Suite 3700
 Miami, FL 33131

ISSUE NOTIFICATION

The projected patent number and issue date are specified above.

Determination of Patent Term Extension or Adjustment under 35 U.S.C. 154 (b)

Design patents have a term measured from the issue date of the patent and the term remains the same length regardless of the time that the application for the design patent was pending. Since the above-identified application is an application for a design patent, the patent is not eligible for Patent Term Extension or Adjustment under 35 U.S.C. 154(b).

Any questions regarding the Patent Term Extension or Adjustment determination should be directed to the Office of Patent Legal Administration at (571)-272-7702. Questions relating to issue and publication fee payments should be directed to the Application Assistance Unit (AAU) of the Office of Data Management (ODM) at (571)-272-4200.

APPLICANT(s) (Please see PAIR WEB site <http://pair.uspto.gov> for additional applicants):

Rui Medeiros Santos, Rotterdam, NETHERLANDS;
 Vacu Vin Innovations Ltd., Delfgauw, NETHERLANDS;
 Sandra van Oosterbaan-Rijnen, Barendrecht, NETHERLANDS;
 Delphine Buyse, Voorburg, NETHERLANDS;

The United States represents the largest, most dynamic marketplace in the world and is an unparalleled location for business investment, innovation, and commercialization of new technologies. The USA offers tremendous resources and advantages for those who invest and manufacture goods here. Through SelectUSA, our nation works to encourage and facilitate business investment. To learn more about why the USA is the best country in the world to develop technology, manufacture products, and grow your business, visit SelectUSA.gov.

PART B – FEE(S) TRANSMITTAL

Complete and send this form, together with the applicable fee(s), by mail or fax, or via EFS-Web.

By mail, send to: Mail Stop ISSUE FEE
 Commissioner for Patents
 P.O. Box 1450
 Alexandria, VA 22313-1450

By fax, send to: (571) 273-2885

INSTRUCTIONS: This form should be used for transmitting the ISSUE FEE and PUBLICATION FEE (if required). Blocks 1 through 5 should be completed where appropriate. All further correspondence including the Patent, advance orders and notification of maintenance fees will be mailed to the current correspondence address as indicated unless corrected below or directed otherwise in Block 1, by (a) specifying a new correspondence address; and/or (b) indicating a separate "FEE ADDRESS" for maintenance fee notifications.

CURRENT CORRESPONDENCE ADDRESS (Note: Use Block 1 for any change of address)

Note: A certificate of mailing can only be used for domestic mailings of the Fee(s) Transmittal. This certificate cannot be used for any other accompanying papers. Each additional paper, such as an assignment or formal drawing, must have its own certificate of mailing or transmission.

Peretz Chesal & Herrmann, P.L.
 2 S. Biscayne Blvd., Suite 3700
 Miami, Florida 33131

Certificate of Mailing or Transmission

I hereby certify that this Fee(s) Transmittal is being deposited with the United States Postal Service with sufficient postage for first class mail in an envelope addressed to the Mail Stop ISSUE FEE address above, or being transmitted to the USPTO via EFS-Web or by facsimile to (571) 273-2885, on the date below.

Alberto Alvarez	(Typed or printed name)
/s/ Alberto Alvarez	(Signature)
April 10, 2020	(Date)

APPLICATION NO	FILING DATE	FIRST NAMED INVENTOR	ATTORNEY DOCKET NO	CONFIRMATION NO
29/625,265	11/08/2017	Rui Medeiros Santos	VVI.001USP	5612

TITLE OF INVENTION:

APPLN. TYPE	ENTITY STATUS	ISSUE FEE DUE	PUBLICATION FEE DUE	PREV. PAID ISSUE FEE	TOTAL FEE(S) DUE	DATE DUE
				\$700	\$0	

EXAMINER	ART UNIT	CLASS-SUBCLASS

1. Change of correspondence address or indication of "Fee Address" (37 CFR 1.363)

- Change of correspondence address (or Change of Correspondence Address form PTO/SB/122) attached.
- "Fee Address" indication (or "Fee Address" Indication form PTO/SB/47; Rev 03-09 or more recent) attached. Use of a Customer Number is required.

2. For printing on the patent front page, list

- (1) The names of up to 3 registered patent attorneys or agents OR, alternatively, 1.
- (2) The name of a single firm (having as a member a registered attorney or agent) and the names of up to 2 registered patent attorneys or agents. If no name is listed, no name will be printed. 2.
- 3.

3. ASSIGNEE NAME AND RESIDENCE DATA TO BE PRINTED ON THE PATENT (print or type)

PLEASE NOTE: Unless an assignee is identified below, no assignee data will appear on the patent. If an assignee is identified below, the document must have been previously recorded, or filed for recordation, as set forth in 37 CFR 3.11 and 37 CFR 3.81(a). Completion of this form is NOT a substitute for filing an assignment.

(A) NAME OF ASSIGNEE

(B) RESIDENCE: (CITY and STATE or COUNTRY)

Please check the appropriate assignee category or categories (will not be printed on the patent): Individual Corporation or other private group entity Government

4a. Fees Submitted: Issue Fee Publication Fee (if required) Advance Order - # of Copies _____

4b. Method of Payment (Please first reapply any previously paid fee shown above):

- Electronic Payment via EFS-Web Enclosed check Non-electronic payment by credit card (Attach form PTO-2038)
- The Director is hereby authorized to charge the required fee(s), any deficiency, or credit any overpayment to Deposit Account No. _____

5. Change of Entity Status (from status indicated above)

- Applicant certifying micro entity status. See 37 CFR 1.29. NOTE: Absent a valid Certification of Micro Entity Status (see forms PTO/SB/15A and 15B), issue fee payment in the micro entity amount will not be accepted at the risk of application abandonment.
- Applicant asserting small entity status. See 37 CFR 1.27. NOTE: If the application was previously under micro entity status, checking this box will be taken as a notification of loss of entitlement to micro entity status.
- Applicant changing to regular undiscounted fee status. NOTE: Checking this box will be taken as a notification of loss of entitlement to small or micro entity status, as applicable.

NOTE: This form must be signed in accordance with 37 CFR 1.31 and 1.33. See 37 CFR 1.4 for signature requirements and certifications.

Authorized Signature /s/Alberto Alvarez

Date 4/10/2020

Typed or printed name: Alberto Alvarez

Registration No. 69260

OMB Clearance and PRA Burden Statement for PTOL-85 Part B

The Paperwork Reduction Act (PRA) of 1995 requires Federal agencies to obtain Office of Management and Budget approval before requesting most types of information from the public. When OMB approves an agency request to collect information from the public, OMB (i) provides a valid OMB Control Number and expiration date for the agency to display on the instrument that will be used to collect the information and (ii) requires the agency to inform the public about the OMB Control Number's legal significance in accordance with 5 CFR 1320.5(b).

The information collected by PTOL-85 Part B is required by 37 CFR 1.311. The information is required to obtain or retain a benefit by the public which is to file (and by the USPTO to process) an application. Confidentiality is governed by 35 U.S.C. 122 and 37 CFR 1.14. This collection is estimated to take 30 minutes to complete, including gathering, preparing, and submitting the completed application form to the USPTO. Time will vary depending upon the individual case. Any comments on the amount of time you require to complete this form and/or suggestions for reducing this burden, should be sent to the Chief Information Officer, U.S. Patent and Trademark Office, U.S. Department of Commerce, P.O. Box 1450, Alexandria, Virginia 22313-1450. DO NOT SEND FEES OR COMPLETED FORMS TO THIS ADDRESS. SEND TO: Commissioner for Patents, P.O. Box 1450, Alexandria, Virginia 22313-1450. Under the Paperwork Reduction Act of 1995, no persons are required to respond to a collection of information unless it displays a valid OMB control number.

Privacy Act Statement

The **Privacy Act of 1974 (P.L. 93-579)** requires that you be given certain information in connection with your submission of the attached form related to a patent application or patent. Accordingly, pursuant to the requirements of the Act, please be advised that: (1) the general authority for the collection of this information is 35 U.S.C. 2(b)(2); (2) furnishing of the information solicited is voluntary; and (3) the principal purpose for which the information is used by the U.S. Patent and Trademark Office is to process and/or examine your submission related to a patent application or patent. If you do not furnish the requested information, the U.S. Patent and Trademark Office may not be able to process and/or examine your submission, which may result in termination of proceedings or abandonment of the application or expiration of the patent.

The information provided by you in this form will be subject to the following routine uses:

1. The information on this form will be treated confidentially to the extent allowed under the Freedom of Information Act (5 U.S.C. 552) and the Privacy Act (5 U.S.C. 552a). Records from this system of records may be disclosed to the Department of Justice to determine whether disclosure of these records is required by the Freedom of Information Act.
2. A record from this system of records may be disclosed, as a routine use, in the course of presenting evidence to a court, magistrate, or administrative tribunal, including disclosures to opposing counsel in the course of settlement negotiations.
3. A record in this system of records may be disclosed, as a routine use, to a Member of Congress submitting a request involving an individual, to whom the record pertains, when the individual has requested assistance from the Member with respect to the subject matter of the record.
4. A record in this system of records may be disclosed, as a routine use, to a contractor of the Agency having need for the information in order to perform a contract. Recipients of information shall be required to comply with the requirements of the Privacy Act of 1974, as amended, pursuant to 5 U.S.C. 552a(m).
5. A record related to an International Application filed under the Patent Cooperation Treaty in this system of records may be disclosed, as a routine use, to the International Bureau of the World Intellectual Property Organization, pursuant to the Patent Cooperation Treaty.
6. A record in this system of records may be disclosed, as a routine use, to another federal agency for purposes of National Security review (35 U.S.C. 181) and for review pursuant to the Atomic Energy Act (42 U.S.C. 218(c)).
7. A record from this system of records may be disclosed, as a routine use, to the Administrator, General Services, or his/her designee, during an inspection of records conducted by GSA as part of that agency's responsibility to recommend improvements in records management practices and programs, under authority of 44 U.S.C. 2904 and 2906. Such disclosure shall be made in accordance with the GSA regulations governing inspection of records for this purpose, and any other relevant (i.e., GSA or Commerce) directive. Such disclosure shall not be used to make determinations about individuals.
8. A record from this system of records may be disclosed, as a routine use, to the public after either publication of the application pursuant to 35 U.S.C. 122(b) or issuance of a patent pursuant to 35 U.S.C. 151. Further, a record may be disclosed, subject to the limitations of 37 CFR 1.14, as a routine use, to the public if the record was filed in an application which became abandoned or in which the proceedings were terminated and which application is referenced by either a published application, an application open to public inspection or an issued patent.
9. A record from this system of records may be disclosed, as a routine use, to a Federal, State, or local law enforcement agency, if the USPTO becomes aware of a violation or potential violation of law or regulation.

UNITED STATES PATENT AND TRADEMARK OFFICE

UNITED STATES DEPARTMENT OF COMMERCE
United States Patent and Trademark Office
 Address: COMMISSIONER FOR PATENTS
 P.O. Box 1450
 Alexandria, Virginia 22313-1450
 www.uspto.gov

APPLICATION NO.	FILING DATE	FIRST NAMED INVENTOR	ATTORNEY DOCKET NO.	CONFIRMATION NO.
29/625,265	11/08/2017	Rui Medeiros Santos	VVI.001USP	5612
155876	7590	04/02/2020	EXAMINER	
Peretz Chesal & Herrmann, P.L. 2 S. Biscayne Blvd., Suite 3700 Miami, FL 33131			PATYK, JANICE JULIA	
			ART UNIT	PAPER NUMBER
			2912	
			NOTIFICATION DATE	DELIVERY MODE
			04/02/2020	ELECTRONIC

Please find below and/or attached an Office communication concerning this application or proceeding.

The time period for reply, if any, is set in the attached communication.

Notice of the Office communication was sent electronically on above-indicated "Notification Date" to the following e-mail address(es):

patents@pch-iplaw.com



UNITED STATES PATENT AND TRADEMARK OFFICE

Commissioner for Patents
 United States Patent and Trademark Office
 P.O. Box 1450
 Alexandria, VA 22313-1450
www.uspto.gov

In re Application of
 Medeiros Santos et al.
 Application No. 29/625,265
 Filed: 8 Nov 2017
 For: UTENSIL REST

:
:
:
:
:
:

DECISION ON PETITION

CORRECTED DECISION¹

This is a decision on the renewed petition filed February 28, 2020, under 37 CFR 1.137(a)², to revive the above-identified application.

The petition is GRANTED.

This application became abandoned July 16, 2019 for failure to timely pay the issue fee in response to the Notice of Allowance Mailed April 15, 2019, and to submit a properly executed inventor's oath or declaration in response to the Notice Requiring Inventor's Oath or Declaration mailed June 25, 2019. Accordingly, a Notice of Abandonment was mailed July 31, 2019. A petition to revive was filed August 20, 2019 but was not filed with the total required for the petition fee, a properly signed oath or declaration or a terminal disclaimer. The petition was dismissed in a decision mailed December 30, 2019.

Thereafter, on January 27, 2020, a request under 37 CFR 1.48(d) was submitted to correct the inventorship and was accepted as evidenced by the corrected filing receipt mailed February 5, 2020.

Comes now petitioner with the instant renewed petition with the balance of the fees due for the issue fee and a Terminal Disclaimer and fee.

All other requirements of 37 CFR 1.137(a) having now been met including the terminal disclaimer and the required fee, this matter is being referred to the Publishing Division.

¹The decision mailed March 31, 2020 is hereby vacated and replaced with this decision.

²Effective December 18, 2013, a grantable petition under 37 CFR 1.137(a) must be accompanied by: (1) the required reply, unless previously filed; (2) the petition fee as set forth in 37 CFR 1.17(m); (3) any terminal disclaimer (and fee as set forth in 37 CFR 1.20(d)) required by 37 CFR 1.137(d) and (4) a statement that the entire delay in filing the required reply from the due date for the reply until the filing of a grantable petition pursuant to 37 CFR 1.137(a) was unintentional; and . Where there is a question as to whether either the abandonment or the delay in filing a petition under 37 CFR 1.137 was unintentional, the Director may require additional information. See MPEP 711.03(c)(II)(C) and (D).

Application No. 29/625,265

Page 2

Telephone inquiries concerning this matter should be directed to the undersigned Attorney at (571) 272-3212.

/Patricia Faison-Ball/

Patricia Faison-Ball
ATTORNEY ADVISOR, OPET

Application Number	Application/Control No. 29/625,265	Applicant(s)/Patent Under Reexamination
Document Code -		Internal Document – DO NOT MAIL

TERMINAL DISCLAIMER	<input checked="" type="checkbox"/> APPROVED	<input type="checkbox"/> DISAPPROVED
Date Filed: 2/28/2020	This patent is subject to a Terminal Disclaimer	

Approved/Disapproved by:	
Petition decision 3/31/2020 Patricia Faison-Ball	



United States Patent and Trademark Office

Office of the Chief Financial Officer

Document Code:WFEE

User :C48879

Sale Accounting Date:03/31/2020

Sale Item Reference Number

29625265

Effective Date

02/08/2020

Document Number	Fee Code	Fee Code Description	Amount Paid	Payment Method
I20203UC58556144	1453	PET. REVIVE ABANDON APP, DELAY PYMT-RESP	\$1,700.00	Salea
I20203UC58556144	1453	PET. REVIVE ABANDON APP, DELAY PYMT-RESP	\$300.00	Salea



UNITED STATES PATENT AND TRADEMARK OFFICE

UNITED STATES DEPARTMENT OF COMMERCE
United States Patent and Trademark Office
 Address: COMMISSIONER FOR PATENTS
 P.O. Box 1450
 Alexandria, Virginia 22313-1450
 www.uspto.gov

APPLICATION NO.	FILING DATE	FIRST NAMED INVENTOR	ATTORNEY DOCKET NO.	CONFIRMATION NO.
29/625,265	11/08/2017	Rui Medeiros Santos	VVI.001USP	5612
155876	7590	03/31/2020	EXAMINER	
Peretz Chesal & Herrmann, P.L. 2 S. Biscayne Blvd., Suite 3700 Miami, FL 33131			PATYK, JANICE JULIA	
			ART UNIT	PAPER NUMBER
			2912	
			NOTIFICATION DATE	DELIVERY MODE
			03/31/2020	ELECTRONIC

Please find below and/or attached an Office communication concerning this application or proceeding.

The time period for reply, if any, is set in the attached communication.

Notice of the Office communication was sent electronically on above-indicated "Notification Date" to the following e-mail address(es):

patents@pch-iplaw.com



UNITED STATES PATENT AND TRADEMARK OFFICE

Commissioner for Patents
 United States Patent and Trademark Office
 P.O. Box 1450
 Alexandria, VA 22313-1450
 www.uspto.gov

In re Application of
 Medeiros Santos et al.
 Application No. 29/625,265
 Filed: 8 Nov 2017
 For: UTENSIL REST

DECISION ON PETITION

This is a decision on the renewed petition filed February 28, 2020, under 37 CFR 1.137(a)¹, to revive the above-identified application.

The petition is DISMISSED.

Any request for reconsideration of this decision must be submitted within TWO (2) MONTHS from the mail date of this decision. Extensions of time under 37 CFR 1.136(a) are permitted. The reconsideration request should include a cover letter entitled "Renewed Petition under 37 CFR 1.137(a)." This is not a final agency action within the meaning of 5 U.S.C. § 704.

This application became abandoned July 16, 2019 for failure to timely pay the issue fee in response to the Notice of Allowance Mailed April 15, 2019, and to submit a properly executed inventor's oath or declaration in response to the Notice Requiring Inventor's Oath or Declaration mailed June 25, 2019. Accordingly, a Notice of Abandonment was mailed July 31, 2019. A petition to revive was filed August 20, 2019 but was not filed with the total required for the petition fee, a properly signed oath or declaration or a terminal disclaimer. The petition was dismissed in a decision mailed December 30, 2019.

Thereafter, on January 27, 2020, a request under 37 CFR 1.48(d) was submitted to correct the inventorship and was accepted as evidenced by the corrected filing receipt mailed February 5, 2020.

¹Effective December 18, 2013, a grantable petition under 37 CFR 1.137(a) must be accompanied by: (1) the required reply, unless previously filed; (2) the petition fee as set forth in 37 CFR 1.17(m); (3) any terminal disclaimer (and fee as set forth in 37 CFR 1.20(d)) required by 37 CFR 1.137(d) and (4) a statement that the entire delay in filing the required reply from the due date for the reply until the filing of a grantable petition pursuant to 37 CFR 1.137(a) was unintentional; and . Where there is a question as to whether either the abandonment or the delay in filing a petition under 37 CFR 1.137 was unintentional, the Director may require additional information. See MPEP 711.03(c)(II)(C) and (D).

However, Rule 37 CFR 1.312 prohibits amendments after the payment of an issue fee. Therefore, as the request for correction of inventorship is an amendment, a petition to withdraw the application from issue pursuant to 37 CFR 1.313 and an express abandonment in favor of a Continued Prosecution Application (CPA) since this is a design application, was required for treatment of the request under 37 CFR 1.48(d).

While the renewed petition has been filed with the balance of the petition fee and a Terminal Disclaimer, the petition is not grantable without the petition to withdraw the application from issue pursuant to 37 CFR 1.313 and an express abandonment in favor of a Continued Prosecution Application (CPA).

The application will therefore remain in an abandoned status until such time as a grantable petition to revive under 37 CFR 1.137(a) has been filed, including a re-filed Terminal Disclaimer because in view of the dismissal of this petition, the Terminal Disclaimer filed with the instant petition will be disapproved.

Petitioner should note that submission of any renewed petition without the required reply will be construed as intentional delay.

Further correspondence with respect to this matter should be addressed as follows:

By mail: Mail Stop PETITIONS
 Commissioner for Patents
 Post Office Box 1450
 Alexandria, VA 22313-1450

By hand: Customer Service Window
 Mail Stop Petitions
 Randolph Building
 401 Dulany Street
 Alexandria, VA 22314

By fax: (571) 273-8300
 ATTN: Office of Petitions

Registered Users may also respond by EFS-Web.

Telephone inquiries concerning this matter should be directed to the undersigned Attorney at (571) 272-3212.

/Patricia Faison-Ball/

Patricia Faison-Ball
ATTORNEY ADVISOR, OPET



United States Patent and Trademark Office

Office of the Chief Financial Officer

Document Code:WFEE

User :C46989

Sale Accounting Date:03/02/2020

Sale Item Reference Number
29625265

Effective Date
02/28/2020

Document Number	Fee Code	Fee Code Description	Amount Paid	Payment Method
I202032008465601	1814	STATUTORY OR TERMINAL DISCLAIMER	\$160.00	Credit Card

RECEIVED
CENTRAL FAX CENTER

FEB 28 2020

STATEMENT
Application No.: 29/625,265
Group Art Unit: 2912
Filing Date: November 8, 2017
Examiner Janice Julia Patyk
Attorney Docket No.: VVI.001USP**IN THE UNITED STATES PATENT AND TRADEMARK OFFICE**

Application Number: 29/625,265
Confirmation No.: 5612
Filing Date: November 8, 2017
Applicant: Vacu Vin Innovations Ltd.
Entitled: UTENSIL REST
Examiner: Janice Julia Patyk
Group Art Unit: 2912
Attorney Docket No.: VVI.001USP

**STATEMENT IN SUPPORT OF RENEWED PETITION FOR REVIVAL OF
APPLICATION FOR PATENT ABANDONMENT UNINTENTIONALLY UNDER
37 CFR 1.137(a)**

Commissioner for Patents
P.O. Box 1450, Alexandria, Virginia 22313-1450
Facsimile: (571) 273-8300

Dear Commissioner:

In response to the Decision of Petition dated December 30, 2019 in the above-captioned application, please be advised that the Petition is hereby renewed to address the deficiencies cited in the Decision of Petition:

1. On August 20, 2019, a Petition for Revival of Application for Patent Abandoned Unintentionally was filed requesting that Application No. 29/625,265 be revived after the application was abandoned for inadvertently failing to pay the Issue Fee.
2. As set forth in the initial Petition and Statement in support thereof, the delay for the payment of the Issue Fee was entirely unintentional and not in any way the fault of the

STATEMENT

Application No.: 29/625,265

Group Art Unit: 2912

Filing Date: November 8, 2017

Examiner Janice Julia Patyk

Attorney Docket No.: VVI.001USP

applicant, and revival of the application and acceptance of the Issue Fee would serve the interests of fairness and justice. The reasons for the delay, as set forth in the Statement in support of the original Petition, are as follows:

- a. Patent attorney Joseph Englander was a patent attorney at the undersigned's law firm, and was previously attorney of record for this application. Mr. Englander left the law firm to join another firm and accordingly updated the contact information associated with his customer number. After leaving the undersigned's law firm, Mr. Englander no longer represented the applicants.
- b. A Notice of Allowance was issued by the USPTO on April 15, 2019. Because the Notice of Allowance was forwarded to Mr. Englander's new law firm, the undersigned and the applicant did not receive and were not aware of the Notice of Allowance.
- c. On August 2, 2019, Mr. Englander forwarded to the undersigned the Notice of Abandonment for failure to pay the Issue Fee by the deadline.
3. On December 30, 2019, a Decision on Petition was issued noting deficiencies in the original Petition, including that (1) the full Issue Fee was not included with the Petition, (2) a Terminal Disclaimer was not submitted with the Petition as required by 37 CFR 1.321, and (3) the correction of the name of the first-named inventor must be completed before the Issue Fee is paid.
4. This Renewed Petition is submitted to address those deficiencies.
5. In order to cure the deficiencies cited in the Decision on Petition, the following is hereby submitted together with this Renewed Petition:

STATEMENT

Application No.: 29/625,265

Group Art Unit: 2912

Filing Date: November 8, 2017

Examiner Janice Julia Patyk

Attorney Docket No.: VVI.001USP

- a. A Terminal Disclaimer pursuant to 37 CFR 1.321, together with payment of the required \$160 fee pursuant to 37 CFR 1.20(d); and
 - b. Payment of the remaining \$300 balance owed for the Issue Fee.
6. Moreover, the correction of the first-named inventor's name was submitted and accepted prior to submitting this Renewed Petition and prior to paying the Issue Fee.
7. Accordingly, the undersigned respectfully requests that the Renewed Petition be granted, that the application be revived, that the USPTO accept the Terminal Disclaimer and remaining \$300 outstanding balance of the Issue Fee, and that a patent thereafter be granted.

Dated February 28, 2020

Respectfully submitted

s/Alberto Alvarez

Alberto Alvarez (Reg. No. 69260)

Peretz Chesal & Herrmann, P.L.

2 S. Biscayne Blvd., Suite 3700

Miami, Florida 33131

T: 305-341-3000

aalvarez@pch-iplaw.com/patents@pch-iplaw.com

02/28/2020 10:51 PERETZ CHESAL & HERRMANN PL

RECEIVED
CENTRAL FAX CENTER

(FAX)305 371 6807

P.006

FEB 28 2020

PTO/AIA/83 (07-16)

Approved for use through 11/30/2020. OMB 0851-0031
U.S. Patent and Trademark Office; U.S. DEPARTMENT OF COMMERCE

Under the Paperwork Reduction Act of 1995, no persons are required to respond to a collection of information unless it displays a valid OMB control number.

TERMINAL DISCLAIMER TO ACCOMPANY PETITION UNDER 37 CFR 1.137 IN A DESIGN APPLICATION FILED ON OR AFTER SEPTEMBER 16, 2012		Docket Number (Optional) VVI.001USP
Applicant:	Vacu Vin Innovations Ltd.	
First named inventor:	Rui Medeiro Santos	
Application No.:	29/625,265	
Filed:	11/8/2017	
For:	UTENSIL REST	
<p>The applicant, <u>Vacu Vin Innovations Ltd.</u>, owner of <u>100</u> percent interest in the instant design application, hereby disclaims a terminal part of the statutory term of any patent granted on the instant design application equivalent to the period of abandonment of the instant design application. This disclaimer also applies to any patent granted on a continuing design application that contains a specific reference under 35 U.S.C. 120, 121, 365(c), or 386(c) to the instant design application. This disclaimer is binding upon the grantee, and its successors or assigns.</p>		
Check either box 1 or 2 below, if appropriate.		
I hereby acknowledge that any willful false statements made are punishable under 18 U.S.C. 1001 by fine or imprisonment of not more than five (5) years, or both.		
1. <input type="checkbox"/> The undersigned is the applicant. If the applicant is an assignee, the undersigned is authorized to act on behalf of the assignee.		
2. <input checked="" type="checkbox"/> The undersigned is an attorney or agent of record. Reg. No. <u>69260</u>		
<u>s/alberto alvarez/</u>		<u>2/28/2020</u>
Signature		Date
<u>Alberto Alvarez</u>		<u>305-341-3000</u>
Typed or printed name		Telephone number
<u>Attorney of record</u>		
Title		
<input checked="" type="checkbox"/> The terminal disclaimer fee under 37 CFR 1.20(d) is included.		
WARNING: Information on this form may become public. Credit card information should not be included on this form. Provide credit card information and authorization on PTO-2038.		

This collection of information is required by 37 CFR 1.137. The information is required to obtain or retain a benefit by the public, i.e., to prosecute a patent application. Confidentiality is governed by 35 U.S.C. 122 and 37 CFR 1.11 and 1.14. This collection is estimated to take 12 minutes to complete, including gathering, preparing, and submitting the completed form to the USPTO. Time will vary depending upon the individual case. Any comments on the amount of time you require to complete this form and/or suggestions for reducing this burden should be sent to the Chief Information Officer, U.S. Patent and Trademark Office, U.S. Department of Commerce, P.O. Box 1450, Alexandria, VA 22313-1450. DO NOT SEND FEES OR COMPLETED FORMS TO THIS ADDRESS. SEND TO: Commissioner for Patents, P.O. Box 1450, Alexandria, VA 22313-1450.

If you need assistance in completing the form, call 1-800-PTO-9199 and select option 2.

Document Code: IMIS

Notice of Fee Due

29/625,265

Date:

3/2/20

Fees are due for the application or document dated 02/28/20. The payment was not collectable for the reason indicated below.

Note: If the fee due is for any of the filing fees, the surcharge for late payment of the filing fees is now due as well.

- Insufficient payment by check or money order.
- No authorization to charge a deposit account. PAR-ELE.004DS
- Invalid deposit account number.
- User name not listed in deposit account ___ at _____ (time).
- Insufficient funds in deposit account _____ at _____ (time).
- Insufficient payment by credit card.
-
- Declined credit card _____ AM (time).

Fee code(s) to be applied:

1502

\$ 700.00

\$

\$

\$

\$

Amount in holding fee code:

1622/2622

\$

\$

1206/2206

\$

1506

\$ 300.00

Total remaining due from applicant:

\$ 400.00

RAM Operator: ST

Protecting your . . . your . . . your . . . and your . . .

Peretz
Chesal
Herrmann

INTELLIGENTIAL PROPERTY LAWYERS®

2 South Biscayne Blvd | Ste 3700 | Miami, FL 33131 | (305) 341-3000 | (305) 371-6807 | pch-iplaw.com

REPLY to:
ALBERT ALVAREZ
305.341.3000
AALVAREZZ@PCH-IPLAW.COMRECEIVED
CENTRAL FAX CENTER

FAX COVER SHEET

February 28, 2020

FEB 28 2020

To: USPTO ATTN: Office of Petitions	Fax: 571-273-8300
From: Erika Montane Legal Assistant for Alberto Alvarez, Esq.	Phone: 305-341-3000
Re: Patent Application No. 29/625,265 Confirmation no.: 5612	

Number of Pages: 8 including this cover page. If you do not receive all of the pages, please call our operator at (305) 341-3000 as soon as possible. If you do not call, we will assume that all pages were received.

COMMENTS:

Attached please find a correspondence dated February 28, 2020, along with enclosures in connection with the above-referenced patent application.

Thank you.

Protecting your . you . your . and your

Peretz
Chesal
Herrmann

2 South Biscayne Blvd | Ste 3700 | Miami, FL 33131 | (305) 341-3000 | (305) 371-6807 | pch-iplaw.com

INTELLIGENT PROTECTIVE LEGAL SERVICES

REPLY to:
ALBERT ALVAREZ
305.341.3000
AALVAREZZ@PCH-IPLAW.COM

February 28, 2020

RECEIVED
CENTRAL FAX CENTER
FEB 28 2020Via Facsimile
(571) 273-8300Patricia Faison-Ball
Commissioner for Patents
401 Dulany Street
Alexandria, VA 22314**Re: Application No.: 29/625,265 – UTENSIL REST**
Group Art Unit: 2912
Filing Date: November 8, 2017
Examiner Janice Julia Patyk
Attorney Docket No.: VVI.001USP

Dear Ms. Faison-Ball:

This firm represents the Applicant in the above-referenced application for a design patent. Pursuant to the USPTO's Decision on Petition entered on December 30, 2019, this cover letter along with its enclosures, shall serve as the applicant's Renewed Petition for Revival of Application for Patent Abandonment Unintentionally Under 37 CFR 1.137(a).

To address the deficiencies cited in the Decision on Petition, the Applicant hereby submits the following:

1. Statement in Support of Renewed Petition for Revival of Application for Patent Abandonment Unintentionally Under 37 CFR 1.137(a);
2. Terminal Disclaimer to Accompany Petition Under 37 CFR 1.137 in Design Application;
3. Credit Card Payment Form for \$160 representing the fee required for the terminal disclaimer; and
4. Credit Card Payment Form for \$300 representing the outstanding balance for the Issue Fee.

If you have any questions or concerns, please do not hesitate to contact me, and thank you for your consideration of this matter.

Sincerely,

PERETZ CHESAL & HERRMANN, P.L.

By: /s Albert Alvarez
Albert Alvarez

Enclosures

UNITED STATES PATENT AND TRADEMARK OFFICE

UNITED STATES DEPARTMENT OF COMMERCE
United States Patent and Trademark Office
 Address: COMMISSIONER FOR PATENTS
 P.O. Box 1450
 Alexandria, Virginia 22313-1450
 www.uspto.gov

APPLICATION NUMBER	FILING OR 371(C) DATE	FIRST NAMED APPLICANT	ATTY. DOCKET NO./TITLE
29/625,265	11/08/2017	Rui Medeiros Santos	VVI.001USP

CONFIRMATION NO. 5612

155876
 Peretz Chesal & Herrmann, P.L.
 2 S. Biscayne Blvd., Suite 3700
 Miami, FL 33131

37 CFR 1.48(f)
ACKNOWLEDGEMENT LETTER



Date Mailed: 02/05/2020

NOTICE OF ACCEPTANCE OF REQUEST UNDER 37 CFR 1.48(f)

This is in response to the applicant's request under 37 CFR 1.48(f) submitted on 01/27/2020.

The request under 37 CFR 1.48(f) to correct the inventorship, to correct or update the name of an inventor, or to correct the order of names of joint inventors is accepted.

Questions about the contents of this notice and the requirements it sets forth should be directed to the Office of Data Management, Application Assistance Unit, at (571) 272-4000 or (571) 272-4200 or 1-888-786-0101.

/hteffer/

UNITED STATES PATENT AND TRADEMARK OFFICE

UNITED STATES DEPARTMENT OF COMMERCE
United States Patent and Trademark Office
 Address: COMMISSIONER FOR PATENTS
 P.O. Box 1450
 Alexandria, Virginia 22313-1450
 www.uspto.gov

APPLICATION NUMBER	FILING or 371(c) DATE	GRP ART UNIT	FIL FEE REC'D	ATTY. DOCKET NO	TOT CLAIMS	IND CLAIMS
29/625,265	11/08/2017	2912	760	VVL001USP	1	1

155876
 Peretz Chesal & Herrmann, P.L.
 2 S. Biscayne Blvd., Suite 3700
 Miami, FL 33131

CONFIRMATION NO. 5612
UPDATED FILING RECEIPT



Date Mailed: 02/05/2020

Receipt is acknowledged of this non-provisional design patent application. The application will be taken up for examination in due course. Applicant will be notified as to the results of the examination. Any correspondence concerning the application must include the following identification information: the U.S. APPLICATION NUMBER, FILING DATE, NAME OF FIRST INVENTOR, and TITLE OF INVENTION. Fees transmitted by check or draft are subject to collection.

Please verify the accuracy of the data presented on this receipt. If an error is noted on this Filing Receipt, please submit a written request for a corrected Filing Receipt, including a properly marked-up ADS showing the changes with strike-through for deletions and underlining for additions. If you received a "Notice to File Missing Parts" or other Notice requiring a response for this application, please submit any request for correction to this Filing Receipt with your reply to the Notice. When the USPTO processes the reply to the Notice, the USPTO will generate another Filing Receipt incorporating the requested corrections provided that the request is grantable.

Inventor(s)

Rui Medeiros Santos, Rotterdam, NETHERLANDS;
 Sandra van Oosterbaan-Rijnen, Barendrecht, NETHERLANDS;
 Delphine Buyse, Voorburg, NETHERLANDS;

Applicant(s)

Vacu Vin Innovations Ltd., Delfgauw, NETHERLANDS;

Power of Attorney: The patent practitioners associated with Customer Number 155876

Domestic Applications for which benefit is claimed - None.

A proper domestic benefit claim must be provided in an Application Data Sheet in order to constitute a claim for domestic benefit. See 37 CFR 1.76 and 1.78.

Foreign Applications for which priority is claimed (You may be eligible to benefit from the **Patent Prosecution Highway** program at the USPTO. Please see <http://www.uspto.gov> for more information.) - None.

Foreign application information must be provided in an Application Data Sheet in order to constitute a claim to foreign priority. See 37 CFR 1.55 and 1.76.

Permission to Access Application via Priority Document Exchange: No

Permission to Access Search Results: Yes

Applicant may provide or rescind an authorization for access using Form PTO/SB/39 or Form PTO/SB/69 as appropriate.

Projected Publication Date: None, application is not eligible for pre-grant publication

Non-Publication Request: No

Early Publication Request: No

Title

UTENSIL REST

Preliminary Class

D07

Statement under 37 CFR 1.55 or 1.78 for AIA (First Inventor to File) Transition Applications: No

PROTECTING YOUR INVENTION OUTSIDE THE UNITED STATES

Since the rights granted by a U.S. patent extend only throughout the territory of the United States and have no effect in a foreign country, an inventor who wishes patent protection in another country must apply for a patent in a specific country or in regional patent offices. Applicants may wish to consider the filing of an international application under the Patent Cooperation Treaty (PCT). An international (PCT) application generally has the same effect as a regular national patent application in each PCT-member country. The PCT process **simplifies** the filing of patent applications on the same invention in member countries, but **does not result** in a grant of "an international patent" and does not eliminate the need of applicants to file additional documents and fees in countries where patent protection is desired.

Almost every country has its own patent law, and a person desiring a patent in a particular country must make an application for patent in that country in accordance with its particular laws. Since the laws of many countries differ in various respects from the patent law of the United States, applicants are advised to seek guidance from specific foreign countries to ensure that patent rights are not lost prematurely.

Applicants also are advised that in the case of inventions made in the United States, the Director of the USPTO must issue a license before applicants can apply for a patent in a foreign country. The filing of a U.S. patent application serves as a request for a foreign filing license. The application's filing receipt contains further information and guidance as to the status of applicant's license for foreign filing.

Applicants may wish to consult the USPTO booklet, "General Information Concerning Patents" (specifically, the section entitled "Treaties and Foreign Patents") for more information on timeframes and deadlines for filing foreign patent applications. The guide is available either by contacting the USPTO Contact Center at 800-786-9199, or it can be viewed on the USPTO website at <http://www.uspto.gov/web/offices/pac/doc/general/index.html>.

For information on preventing theft of your intellectual property (patents, trademarks and copyrights), you may wish to consult the U.S. Government website, <http://www.stopfakes.gov>. Part of a Department of Commerce initiative, this website includes self-help "toolkits" giving innovators guidance on how to protect intellectual property in specific countries such as China, Korea and Mexico. For questions regarding patent enforcement issues, applicants may call the U.S. Government hotline at 1-866-999-HALT (1-866-999-4258).

LICENSE FOR FOREIGN FILING UNDER
Title 35, United States Code, Section 184
Title 37, Code of Federal Regulations, 5.11 & 5.15

GRANTED

The applicant has been granted a license under 35 U.S.C. 184, if the phrase "IF REQUIRED, FOREIGN FILING LICENSE GRANTED" followed by a date appears on this form. Such licenses are issued in all applications where the conditions for issuance of a license have been met, regardless of whether or not a license may be required as set forth in 37 CFR 5.15. The scope and limitations of this license are set forth in 37 CFR 5.15(a) unless an earlier license has been issued under 37 CFR 5.15(b). The license is subject to revocation upon written notification. The date indicated is the effective date of the license, unless an earlier license of similar scope has been granted under 37 CFR 5.13 or 5.14.

This license is to be retained by the licensee and may be used at any time on or after the effective date thereof unless it is revoked. This license is automatically transferred to any related applications(s) filed under 37 CFR 1.53(d). This license is not retroactive.

The grant of a license does not in any way lessen the responsibility of a licensee for the security of the subject matter as imposed by any Government contract or the provisions of existing laws relating to espionage and the national security or the export of technical data. Licensees should apprise themselves of current regulations especially with respect to certain countries, of other agencies, particularly the Office of Defense Trade Controls, Department of State (with respect to Arms, Munitions and Implements of War (22 CFR 121-128)); the Bureau of Industry and Security, Department of Commerce (15 CFR parts 730-774); the Office of Foreign Assets Control, Department of Treasury (31 CFR Parts 500+) and the Department of Energy.

NOT GRANTED

No license under 35 U.S.C. 184 has been granted at this time, if the phrase "IF REQUIRED, FOREIGN FILING LICENSE GRANTED" DOES NOT appear on this form. Applicant may still petition for a license under 37 CFR 5.12, if a license is desired before the expiration of 6 months from the filing date of the application. If 6 months has lapsed from the filing date of this application and the licensee has not received any indication of a secrecy order under 35 U.S.C. 181, the licensee may foreign file the application pursuant to 37 CFR 5.15(b).

SelectUSA

The United States represents the largest, most dynamic marketplace in the world and is an unparalleled location for business investment, innovation, and commercialization of new technologies. The U.S. offers tremendous resources and advantages for those who invest and manufacture goods here. Through SelectUSA, our nation works to promote and facilitate business investment. SelectUSA provides information assistance to the international investor community; serves as an ombudsman for existing and potential investors; advocates on behalf of U.S. cities, states, and regions competing for global investment; and counsels U.S. economic development organizations on investment attraction best practices. To learn more about why the United States is the best country in the world to develop technology, manufacture products, deliver services, and grow your business, visit <http://www.SelectUSA.gov> or call +1-202-482-6800.

To: Page 1 of 10

2020-01-27 17:29:49 (GMT)

RECEIVED
CENTRAL FAX CENTER

From: Tod Aronovitz

JAN 27 2020

FAX COVER SHEET

TO	
COMPANY	
FAX NUMBER	15712738300
FROM	Tod Aronovitz
DATE	2020-01-27 17:29:29 GMT
RE	Fax to US Patent Office

COVER MESSAGE

To: Page 2 of 10

2020-01-27 17:29:49 (GMT)

From: Tod Aronovitz



RECEIVED
CENTRAL FAX CENTER
JAN 27 2020

FAX COVER SHEET

January 27, 2020

To: U.S. Patent Office	Fax: 571-273-8300
From: Erika Montane Legal Assistant for Alberto Alvarez, Esq.	Phone: 305-341-3000
Re: Patent Application No. 29/625,265 Confirmation no.: 5612	

Number of Pages: 9 including this cover page. If you do not receive all of the pages, please call our operator at (305) 341-3000 as soon as possible. If you do not call, we will assume that all pages were received.

COMMENTS:

Attached please find a corrected Application Data Sheet being submitted in response to the Response to Request for Corrected Filing Receipt in connection with the above-referenced application.

Thank you.

RECEIVED
 CENTRAL FAX CENTER

To: Page 3 of 10

2020-01-27 17:29:49 (GMT)

From: Tod Aronovitz

JAN 27 2020

PTC/AW/4 (11-15)

Approved for use through 04/30/2017. OMB DESI-0032
 U.S. Patent and Trademark Office; U.S. DEPARTMENT OF COMMERCE

Under the Paperwork Reduction Act of 1995, no persons are required to respond to a collection of information unless it contains a valid OMB control number.

Application Data Sheet 37 CFR 1.76		Attorney Docket Number	WI.001USP
		Application Number	
Title of invention	UTENSIL REST		
The application data sheet is part of the provisional or nonprovisional application for which it is being submitted. The following form contains the bibliographic data arranged in a format specified by the United States Patent and Trademark Office as outlined in 37 CFR 1.76. This document may be completed electronically and submitted to the Office in electronic format using the Electronic Filing System (EFS) or the document may be printed and included in a paper filed application.			

Secrecy Order 37 CFR 5.2:

Portions or all of the application associated with this Application Data Sheet may fall under a Secrecy Order pursuant to 37 CFR 5.2. (Paper filers only. Applications that fall under Secrecy Order may not be filed electronically.)

Inventor Information:

Inventor 1				
Legal Name				
Prefix	Given Name	Middle Name	Family Name	Suffix
	Rui	Medeiros	Medeiros Santos	
Residence Information (Select One) <input type="radio"/> US Residency <input checked="" type="radio"/> Non US Residency <input type="radio"/> Active US Military Service				
City	Rotterdam	Country of Residence	NL	
Mailing Address of Inventor:				
Address 1		Wasbloem 16		
Address 2				
City	Rotterdam	State/Province		
Postal Code	3088 AT	Country	NL	
Inventor 2				
Legal Name				
Prefix	Given Name	Middle Name	Family Name	Suffix
	Sandra		van Oosterbaan-Rijnen	
Residence Information (Select One) <input type="radio"/> US Residency <input checked="" type="radio"/> Non US Residency <input type="radio"/> Active US Military Service				
City	Barendrecht	Country of Residence	NL	
Mailing Address of Inventor:				
Address 1		Boeler 93		
Address 2				
City	Barendrecht	State/Province		
Postal Code	2991 KE	Country	NL	
Inventor 3				
Legal Name				

EFS Web 2.2.12

PTO/AIA/14 (11-15)

Approved for use through 01/30/2017. OMB 0651-0032

U.S. Patent and Trademark Office, U.S. DEPARTMENT OF COMMERCE

Under the Paperwork Reduction Act of 1995, no persons are required to respond to a collection of information unless it contains a valid OMB control number.

Application Data Sheet 37 CFR 1.76		Attorney Docket Number	WI.001USP	
		Application Number		
Title of Invention	UTENSIL REST			
Prefix	Given Name	Middle Name	Family Name	Suffix
	Delphine		Buysé	
Residence Information (Select One) <input type="radio"/> US Residency <input checked="" type="radio"/> Non US Residency <input type="radio"/> Active US Military Service				
City	Voorburg	Country of Residence	NL	
Mailing Address of Inventor:				
Address 1	Van Halswijnlaan 167			
Address 2				
City	Voorburg	State/Province		
Postal Code	2274 TG	Country	NL	
All Inventors Must Be Listed - Additional Inventor Information blocks may be generated within this form by selecting the Add button.				

Correspondence Information:

Enter either Customer Number or complete the Correspondence Information section below. For further information see 37 CFR 1.33(a).			
<input type="checkbox"/> An Address is being provided for the correspondence information of this application.			
Customer Number	436906- 155876		
Email Address	patents@pch-iplaw.com		
Email Address	jeinglander@pch-iplaw.com	salvarez@pch-iplaw.com	

Application Information:

Title of the Invention	UTENSIL REST		
Attorney Docket Number	WI.001USP	Small Entity Status Claimed	<input type="checkbox"/>
Application Type	Nonprovisional		
Subject Matter	Design		
Total Number of Drawing Sheets (if any)	7	Suggested Figure for Publication (if any)	1

Filing By Reference:

Only complete this section when filing an application by reference under 35 U.S.C. 111(c) and 37 CFR 1.57(a). Do not complete this section if application papers including a specification and any drawings are being filed. Any domestic benefit or foreign priority information must be provided in the appropriate section(s) below (i.e., "Domestic Benefit/National Stage information" and "Foreign Priority Information").

For the purposes of a filing date under 37 CFR 1.53(b), the description and any drawings of the present application are replaced by this

Application number of the previously filed application	Filing date (YYYY-MM-DD)	Intellectual Property Authority or Country

EFS Web 2.2.12

PTC/AA/14 (11-15)
 Approved for use through 04/30/2017. OMB 0651-0032
 U.S. Patent and Trademark Office, U.S. DEPARTMENT OF COMMERCE
 Under the Paperwork Reduction Act of 1995, no persons are required to respond to a collection of information unless it contains a valid OMB control number.

Application Data Sheet 37 CFR 1.76		Attorney Docket Number	VVI.001USP
		Application Number	
Title of Invention	LITENSIL REST		

Publication Information:

Request Early Publication (Fee required at time of Request 37 CFR 1.219)

Request Not to Publish. I hereby request that the attached application not be published under 35 U.S.C. 122(b) and certify that the invention disclosed in the attached application has not and will not be the subject of an application filed in another country, or under a multilateral international agreement, that requires publication at eighteen months after filing.

Representative Information:

Representative information should be provided for all practitioners having a power of attorney in the application. Providing this information in the Application Data Sheet does not constitute a power of attorney in the application (see 37 CFR 1.32). Either enter Customer Number or complete the Representative Name section below. If both sections are completed the customer number will be used for the Representative Information during processing.

Please Select One: Customer Number US Patent Practitioner Limited Recognition (37 CFR 11.9)

Customer Number: +99995 155876

Domestic Benefit/National Stage Information:

This section allows for the applicant to either claim benefit under 35 U.S.C. 119(e), 120, 121, 365(c), or 386(c) or indicate National Stage entry from a PCT application. Providing benefit claim information in the Application Data Sheet constitutes the specific reference required by 35 U.S.C. 119(e) or 120, and 37 CFR 1.78. When referring to the current application, please leave the "Application Number" field blank.

Prior Application Status			
Application Number	Continuity Type	Prior Application Number	Filing or 371(c) Date (YYYY-MM-DD)

Additional Domestic Benefit/National Stage Data may be generated within this form by selecting the Add button.

Foreign Priority Information:

This section allows for the applicant to claim priority to a foreign application. Providing this information in the application data sheet constitutes the claim for priority as required by 35 U.S.C. 119(b) and 37 CFR 1.55. When priority is claimed to a foreign application that is eligible for retrieval under the priority document exchange program (PDX), the information will be used by the Office to automatically attempt retrieval pursuant to 37 CFR 1.55(i)(1) and (2). Under the PDX program, applicant bears the ultimate responsibility for ensuring that a copy of the foreign application is received by the Office from the participating foreign intellectual property office, or a certified copy of the foreign priority application is filed, within the time period specified in 37 CFR 1.55(g)(1).

EFS Web 2.2.12

To: Page 6 of 10

2020-01-27 17:29:49 (GMT)

From: Tod Aronovitz

PTO/AIA/14 (11-15)

Approved for use through 04/30/2017. CMB 0561-0032

U.S. Patent and Trademark Office; U.S. DEPARTMENT OF COMMERCE

Under the Paperwork Reduction Act of 1996, no persons are required to respond to a collection of information unless it contains a valid OMB control number.

Application Data Sheet 37 CFR 1.76		Attorney Docket Number	VVI.001USP
		Application Number	
Title of Invention	UTENSIL REST.		
Application Number	Country	Filing Date (YYYY-MM-DD)	Access Code (if applicable)
Additional Foreign Priority Data may be generated within this form by selecting the Add button.			

Statement under 37 CFR 1.55 or 1.78 for AIA (First Inventor to File) Transition Applications

This application (1) claims priority to or the benefit of an application filed before March 16, 2013 and (2) also contains, or contained at any time, a claim to a claimed invention that has an effective filing date on or after March 16, 2013.

NOTE: By providing this statement under 37 CFR 1.55 or 1.78, this application, with a filing date on or after March 16, 2013, will be examined under the first inventor to file provisions of the AIA.

EFS Web 2.2.12

RECEIVED
RECEIVED
CENTRAL FAX CENTER

To: Page 7 of 10

2020-01-27 17:29:49 (GMT)

From: Tod Aronovitz

JAN 27 2020

PTO/AIA/14 (11-15)

Approved for use through 04/30/2017. OMB 0651-0032

U.S. Patent and Trademark Office; U.S. DEPARTMENT OF COMMERCE

Under the Paperwork Reduction Act of 1995, no persons are required to respond to a collection of information unless it contains a valid OMB control number.

Application Data Sheet 37 CFR 1.76		Attorney Docket Number	VVI.001USP
		Application Number	
Title of Invention	UTENSIL REST		

Authorization or Opt-Out of Authorization to Permit Access:

When this Application Data Sheet is properly signed and filed with the application, applicant has provided written authority to permit a participating foreign intellectual property (IP) office access to the instant application-as-filed (see paragraph A in subsection 1 below) and the European Patent Office (EPO) access to any search results from the instant application (see paragraph B in subsection 1 below).

Should applicant choose not to provide an authorization identified in subsection 1 below, applicant must opt-out of the authorization by checking the corresponding box A or B or both in subsection 2 below.

NOTE: This section of the Application Data Sheet is ONLY reviewed and processed with the INITIAL filing of an application. After the initial filing of an application, an Application Data Sheet cannot be used to provide or rescind authorization for access by a foreign IP office(s). Instead, Form PTO/SB/39 or PTO/SB/69 must be used as appropriate.

1. Authorization to Permit Access by a Foreign Intellectual Property Office(s)

A. Priority Document Exchange (PDX) - Unless box A in subsection 2 (opt-out of authorization) is checked, the undersigned hereby grants the USPTO authority to provide the European Patent Office (EPO), the Japan Patent Office (JPO), the Korean Intellectual Property Office (KIPO), the State Intellectual Property Office of the People's Republic of China (SIPO), the World Intellectual Property Organization (WIPO), and any other foreign intellectual property office participating with the USPTO in a bilateral or multilateral priority document exchange agreement in which a foreign application claiming priority to the instant patent application is filed, access to: (1) the instant patent application-as-filed and its related bibliographic data, (2) any foreign or domestic application to which priority or benefit is claimed by the instant application and its related bibliographic data, and (3) the date of filing of this Authorization. See 37 CFR 1.14(h)(1).

B. Search Results from U.S. Application to EPO - Unless box B in subsection 2 (opt-out of authorization) is checked, the undersigned hereby grants the USPTO authority to provide the EPO access to the bibliographic data and search results from the instant patent application when a European patent application claiming priority to the instant patent application is filed. See 37 CFR 1.14(h)(2).

The applicant is reminded that the EPO's Rule 141(1) EPC (European Patent Convention) requires applicants to submit a copy of search results from the instant application without delay in a European patent application that claims priority to the instant application.

2. Opt-Out of Authorizations to Permit Access by a Foreign Intellectual Property Office(s)

A. Applicant **DOES NOT** authorize the USPTO to permit a participating foreign IP office access to the instant application-as-filed. If this box is checked, the USPTO will not be providing a participating foreign IP office with any documents and information identified in subsection 1A above.

B. Applicant **DOES NOT** authorize the USPTO to transmit to the EPO any search results from the instant patent application. If this box is checked, the USPTO will not be providing the EPO with search results from the instant application.

NOTE: Once the application has published or is otherwise publicly available, the USPTO may provide access to the application in accordance with 37 CFR 1.14.

EFS Web 2.2.12

PTO/AIA/14 (11-15)

Approved for use through 04/30/2017. OMB 0851-0032

U.S. Patent and Trademark Office; U.S. DEPARTMENT OF COMMERCE

Under the Paperwork Reduction Act of 1995, no persons are required to respond to a collection of information unless it contains a valid OMB control number.

Application Data Sheet 37 CFR 1.76		Attorney Docket Number	VI.001USP
		Application Number	
Title of Invention	UTENSIL REST		

Applicant Information:

Providing assignment information in this section does not substitute for compliance with any requirement of part 3 of Title 37 of CFR to have an assignment recorded by the Office.

Applicant 1

If the applicant is the inventor (or the remaining joint inventor or inventors under 37 CFR 1.45), this section should not be completed. The information to be provided in this section is the name and address of the legal representative who is the applicant under 37 CFR 1.43; or the name and address of the assignee, person to whom the inventor is under an obligation to assign the invention, or person who otherwise shows sufficient proprietary interest in the matter who is the applicant under 37 CFR 1.46. If the applicant is an applicant under 37 CFR 1.46 (assignee, person to whom the inventor is obligated to assign, or person who otherwise shows sufficient proprietary interest) together with one or more joint inventors, then the joint inventor or inventors who are also the applicant should be identified in this section.

Assignee Legal Representative under 35 U.S.C. 117 Joint Inventor

Person to whom the inventor is obligated to assign. Person who shows sufficient proprietary interest

If applicant is the legal representative, indicate the authority to file the patent application, the inventor is:

Name of the Deceased or Legally Incapacitated Inventor: _____

If the Applicant is an Organization check here.

Organization Name Vecu Vin Innovations Ltd.

Mailing Address Information For Applicant:

Address 1 Groothandelsweg 1

Address 2

City Delfgauw State/Province

Country NL Postal Code 2645 EH

Phone Number Fax Number

Email Address

Additional Applicant Data may be generated within this form by selecting the Add button.

Assignee Information Including Non-Applicant Assignee Information:

Providing assignment information in this section does not substitute for compliance with any requirement of part 3 of Title 37 of CFR to have an assignment recorded by the Office.

PTO/AIA/14 (11-15)

Approved for use through 04/30/2017. OMB 0861-0032

U.S. Patent and Trademark Office; U.S. DEPARTMENT OF COMMERCE

Under the Paperwork Reduction Act of 1993, no persons are required to respond to a collection of information unless it contains a valid OMB control number.

Application Data Sheet 37 CFR 1.76		Attorney Docket Number	VVI,001USP	
		Application Number		
Title of Invention	UTENSIL REST			
Assignee 1				
Complete this section if assignee information, including non-applicant assignee information, is desired to be included on the patent application publication. An assignee-applicant identified in the "Applicant Information" section will appear on the patent application publication as an applicant. For an assignee-applicant, complete this section only if identification as an assignee is also desired on the patent application publication.				
Signature:				
If the Assignee or Non-Applicant Assignee is an Organization check here. <input checked="" type="checkbox"/>				
Organization Name	Vacu Vin Innovations Ltd.			
Mailing Address Information For Assignee including Non-Applicant Assignee:				
Address 1	Groothandelsweg 1			
Address 2				
City	Delfgauw	State/Province		
Country	NL	Postal Code	2645 EH	
Phone Number			Fax Number	
Email Address				
Additional Assignee or Non-Applicant Assignee Data may be generated within this form by selecting the Add button.				

Signature:

NOTE: This Application Data Sheet must be signed in accordance with 37 CFR 1.33(b). However, if this Application Data Sheet is submitted with the INITIAL filing of the application and either box A or B is not checked in subsection 2 of the "Authorization or Opt-Out of Authorization to Permit Access" section, then this form must also be signed in accordance with 37 CFR 1.14(c). This Application Data Sheet must be signed by a patent practitioner if one or more of the applicants is a juristic entity (e.g., corporation or association). If the applicant is two or more joint inventors, this form must be signed by a patent practitioner, all joint inventors who are the applicant, or one or more joint inventor-applicants who have been given power of attorney (e.g., see USPTO Form PTO/AIA/81) on behalf of all joint inventor-applicants. See 37 CFR 1.4(d) for the manner of making signatures and certifications.

Signature	Joseph C. Englander /alberto alvarez/		Date (YYYY-MM-DD)	2017-11-08 2020-01-24	
First Name	Joseph Alberto	Last Name	Englander Alvarez	Registration Number	98871 69260
Additional Signature may be generated within this form by selecting the Add button.					

EF5 Web 2.2.12

PTO/AIA/14 (11-16)

Approved for use through 04/30/2017. OMB 0651-0032

U.S. Patent and Trademark Office, U.S. DEPARTMENT OF COMMERCE

Under the Paperwork Reduction Act of 1995, no persons are required to respond to a collection of information unless it contains a valid OMB control number.

Application Data Sheet 37 CFR 1.76		Attorney Docket Number	WI.001USP
		Application Number	
Title of Invention	UTENSIL REST		

This collection of information is required by 37 CFR 1.76. The information is required to obtain or retain a benefit by the public which is to file (and by the USPTO to process) an application. Confidentiality is governed by 35 U.S.C. 122 and 37 CFR 1.14. This collection is estimated to take 23 minutes to complete, including gathering, preparing, and submitting the completed application data sheet form to the USPTO. Time will vary depending upon the individual case. Any comments on the amount of time you require to complete this form and/or suggestions for reducing this burden, should be sent to the Chief Information Officer, U.S. Patent and Trademark Office, U.S. Department of Commerce, P.O. Box 1450, Alexandria, VA 22313-1450. DO NOT SEND FEES OR COMPLETED FORMS TO THIS ADDRESS. SEND TO: Commissioner for Patents, P.O. Box 1460, Alexandria, VA 22313-1460.

EFS Web 2.2.12

UNITED STATES PATENT AND TRADEMARK OFFICE

UNITED STATES DEPARTMENT OF COMMERCE
United States Patent and Trademark Office
 Address: COMMISSIONER FOR PATENTS
 P.O. Box 1450
 Alexandria, Virginia 22313-1450
 www.uspto.gov

APPLICATION NUMBER	FILING OR 371(C) DATE	FIRST NAMED APPLICANT	ATTY. DOCKET NO./TITLE
29/625,265	11/08/2017	Rui Medeiros	VVI.001USP

CONFIRMATION NO. 5612

155876
 Peretz Chesal & Herrmann, P.L.
 2 S. Biscayne Blvd., Suite 3700
 Miami, FL 33131

37 CFR 1.48(f)
ACKNOWLEDGEMENT LETTER



Date Mailed: 01/17/2020

IMPROPER SUBMISSION OF REQUEST UNDER 37 CFR 1.48(f)

The request under 37 CFR 1.48(f) (request to change inventorship) submitted on 08/20/2019 in the above-identified application is not accepted because:

- The request to correct or update the name of the inventor or a joint inventor, or the order of the names of joint inventors, under 37 CFR 1.48(f) is deficient because a corrected or updated application data sheet (ADS) in compliance with 37 CFR 1.76 (including markings showing the changes) has not been submitted. Any renewed request must include a corrected or updated ADS in compliance with 37 CFR 1.76 that identifies the information being changed, with underlining for insertions, and strike-through or brackets for text removed.

Questions about the contents of this notice and the requirements it sets forth should be directed to the Office of Data Management, Application Assistance Unit, at (571) 272-4000 or (571) 272-4200 or 1-888-786-0101.

/ewodaje/



UNITED STATES PATENT AND TRADEMARK OFFICE

UNITED STATES DEPARTMENT OF COMMERCE
 United States Patent and Trademark Office
 Address: COMMISSIONER FOR PATENTS
 P.O. Box 1450
 Alexandria, Virginia 22313-1450
 www.uspto.gov

APPLICATION NUMBER	FILING OR 371(C) DATE	FIRST NAMED APPLICANT	ATTY. DOCKET NO./TITLE
29/625,265	11/08/2017	Rui Medeiros	VVI.001USP

CONFIRMATION NO. 5612

IMPROPER CFR REQUEST



Date Mailed: 01/17/2020

155876

Peretz Chesal & Herrmann, P.L.
 2 S. Biscayne Blvd., Suite 3700
 Miami, FL 33131

RESPONSE TO REQUEST FOR CORRECTED FILING RECEIPT

Power of Attorney, Claims, Fees, System Limitations, and Miscellaneous

In response to your request for a corrected Filing Receipt, the Office is unable to comply with your request because:

- The ADS received on 08/20/2019 was not properly signed. Therefore, the Office will treat it only as a transmittal letter. See 37 CFR 1.76(e). Inventorship has not been set by this document and any foreign priority or domestic benefit claims contained therein are ineffective. See 37 CFR 1.55 or 37 CFR 1.78.

If the applicant wishes to submit another ADS:

- o It must be properly signed by a party under 37 CFR 1.33(b), and be signed in compliance with 37 CFR 1.4(d).
- o Changes to the information of record must be properly marked up in compliance with 37 CFR 1.76(c), i.e., must identify the information that is being changed, with underlining for insertions, and strike-through or brackets for text removed. In general, the identification of the information being changed should be made relative to the most recent filing receipt.
- o Benefit and priority claims must be presented in an ADS in compliance with 37 CFR 1.76(c) and within the time periods specified in 37 CFR 1.55 and 1.78.

If an ADS as set forth above is provided, the filing of the inventor's oath or declaration may be postponed until the application is otherwise in condition for allowance. See 37 CFR 1.53(f). Note that the inventor's oath or declaration must be filed no later than the date on which the issue fee has been paid.

In order to make changes to the information of record, an ADS must be properly signed and properly marked up relative to the current information of record.

Proper signature: The ADS must be signed with a handwritten signature or proper S-signature by:

- A patent practitioner, with the practitioner's registration number accompanying the signature (e.g., immediately below or adjacent to the signature), or
- The applicant, if the applicant is an individual other than the inventor(s) and no power of attorney has been appointed, or
- All of the inventors, if no other applicant has been established and no power of attorney has been appointed.

A proper S-signature consists of only letters and/or Arabic numerals, with appropriate spaces and commas, periods, apostrophes, or hyphens for punctuation contained between a first single forward slash mark before, and a second single forward slash mark after, the S-signature.

Proper markings: The ADS must identify the changes being made with underlining for insertions and strike-through or brackets for text removed. No other markings or indications are acceptable. Where an ADS providing corrected or updated information does not contain all of the sections of the ADS, the entire section in

which changes are being made must be included in the ADS. Information of record can generally be found on the latest filing receipt.

Questions about the contents of this notice and the requirements it sets forth should be directed to the Office of Data Management, Application Assistance Unit, at **(571) 272-4000** or **(571) 272-4200** or **1-888-786-0101**.

/ewodaje/

UNITED STATES PATENT AND TRADEMARK OFFICE
COMMISSIONER FOR PATENTS
P.O. BOX 1450
ALEXANDRIA VA 22313-1451

PRESORTED
FIRST-CLASS MAIL
U.S. POSTAGE PAID
POSTEDIGITAL
NNNNN

Peretz Chesal & Herrmann, P.L.
2 S. Biscayne Blvd., Suite 3700
Miami, FL 33131



**Courtesy Reminder for
Application Serial No: 29/625,265**

Attorney Docket No: VVI.001USP

Customer Number: 155876

Date of Electronic Notification: 12/30/2019

This is a courtesy reminder that new correspondence is available for this application. If you have not done so already, please review the correspondence. The official date of notification of the outgoing correspondence will be indicated on the form PTOL-90 accompanying the correspondence.

An email notification regarding the correspondence was sent to the following email address(es) associated with your customer number:
patents@pch-iplaw.com

To view your correspondence online or update your email addresses, please visit us anytime at <https://ppair-my.uspto.gov/pair/PrivatePair>.
If you have any questions, please email the Electronic Business Center (EBC) at EBC@uspto.gov or call 1-866-217-9197.

UNITED STATES PATENT AND TRADEMARK OFFICE

UNITED STATES DEPARTMENT OF COMMERCE
United States Patent and Trademark Office
 Address: COMMISSIONER FOR PATENTS
 P.O. Box 1450
 Alexandria, Virginia 22313-1450
 www.uspto.gov

APPLICATION NO.	FILING DATE	FIRST NAMED INVENTOR	ATTORNEY DOCKET NO.	CONFIRMATION NO.
29/625,265	11/08/2017	Rui Medeiros	VVI.001USP	5612
155876	7590	12/30/2019	EXAMINER	
Peretz Chesal & Herrmann, P.L. 2 S. Biscayne Blvd., Suite 3700 Miami, FL 33131			PATYK, JANICE JULIA	
			ART UNIT	PAPER NUMBER
			2912	
			NOTIFICATION DATE	DELIVERY MODE
			12/30/2019	ELECTRONIC

Please find below and/or attached an Office communication concerning this application or proceeding.

The time period for reply, if any, is set in the attached communication.

Notice of the Office communication was sent electronically on above-indicated "Notification Date" to the following e-mail address(es):

patents@pch-iplaw.com



UNITED STATES PATENT AND TRADEMARK OFFICE

Commissioner for Patents
 United States Patent and Trademark Office
 P.O. Box 1450
 Alexandria, VA 22313-1450
 www.uspto.gov

In re Application of
 Medeiros et al.
 Application No. 29/625,265
 Filed: 8 Nov 2017
 For: UTENSIL REST

DECISION ON PETITION

This is a decision on the petition filed August 20, 2019, under 37 CFR 1.137(a), to revive the above-identified application.

The petition is DISMISSED.

Any request for reconsideration of this decision must be submitted within TWO (2) MONTHS from the mail date of this decision. Extensions of time under 37 CFR 1.136(a) are permitted. The reconsideration request should include a cover letter entitled "Renewed Petition under 37 CFR 1.137(a)". This is not a final agency decision.

This application became abandoned July 16, 2019 for failure to timely pay the issue fee in response to the Notice of Allowance Mailed April 15, 2019, and to submit a properly executed inventor's oath or declaration in response to the Notice Requiring Inventor's Oath or Declaration mailed June 25, 2019. Accordingly, a Notice of Abandonment was mailed July 31, 2019.

Pursuant to 37 CFR 1.137(a) however, the instant petition lacks compliance with items (2) and (4) of the regulation.

The petition fee has been proffered with an authorization to charge the issue fee to a credit card. However, the charge to the credit card provided for the petition fee was declined. Since no authorizations for debiting a deposit account or any other method of payment was provided for any deficiencies, the petition to revive is not grantable.

Additionally, a petition to revive in a design application is required to be accompanied by a Terminal Disclaimer and the fee as set forth in 37 CFR 1.20(d).

Finally, on August 20, 2019 a request under 37 CFR 1.48(d) was submitted to correct the inventorship by correcting the name of the first named inventor.

Petitioners are reminded that Rule 37 CFR 1.312 prohibits amendments after the payment of an issue fee. Therefore, as the request for correction of inventorship is an amendment, a petition to withdraw the application from issue pursuant to 37 CFR 1.313 and an express abandonment in favor of a Continued Prosecution Application (CPA) since this is a design application, would be required for treatment of the request under 37 CFR 1.48(d).

The application will therefore remain in an abandoned status until such time as the above noted deficiencies have been cured.

Petitioner should note that submission of any renewed petition without the required reply will be construed as intentional delay.

Further correspondence with respect to this matter should be addressed as follows:

By mail: Mail Stop PETITIONS
 Commissioner for Patents
 Post Office Box 1450
 Alexandria, VA 22313-1450

By hand: Customer Service Window
 Mail Stop Petitions
 Randolph Building
 401 Dulany Street
 Alexandria, VA 22314

By fax: (571) 273-8300
 ATTN: Office of Petitions

Registered Users may also respond by EFS-Web.

Telephone inquiries concerning this matter should be directed to the undersigned Attorney at (571) 272-3212.

/Patricia Faison-Ball/

Patricia Faison-Ball
ATTORNEY ADVISOR, OPET

UNITED STATES PATENT AND TRADEMARK OFFICE

UNITED STATES DEPARTMENT OF COMMERCE
United States Patent and Trademark Office
 Address: COMMISSIONER FOR PATENTS
 P.O. Box 1450
 Alexandria, Virginia 22313-1450
 www.uspto.gov

APPLICATION NUMBER	FILING OR 371(C) DATE	FIRST NAMED APPLICANT	ATTY. DOCKET NO./TITLE
29/625,265	11/08/2017	Rui Medeiros	VVI.001USP

CONFIRMATION NO. 5612
POWER OF ATTORNEY NOTICE

OC000000110760219

Date Mailed: 08/29/2019

139305
 Fowler White Burnett, P.A.
 1395 Brickell Avenue, 14th Floor
 Miami, FL 33131

NOTICE REGARDING CHANGE OF POWER OF ATTORNEY

This is in response to the Power of Attorney filed 08/20/2019.

- The Power of Attorney to you in this application has been revoked by the applicant. Future correspondence will be mailed to the new address of record(37 CFR 1.33).

Questions about the contents of this notice and the requirements it sets forth should be directed to the Office of Data Management, Application Assistance Unit, at (571) 272-4000 or (571) 272-4200 or 1-888-786-0101.

/sleutchit/

UNITED STATES PATENT AND TRADEMARK OFFICE

UNITED STATES DEPARTMENT OF COMMERCE
United States Patent and Trademark Office
 Address: COMMISSIONER FOR PATENTS
 P.O. Box 1450
 Alexandria, Virginia 22313-1450
 www.uspto.gov

APPLICATION NUMBER	FILING OR 371(C) DATE	FIRST NAMED APPLICANT	ATTY. DOCKET NO./TITLE
29/625,265	11/08/2017	Rui Medeiros	VVI.001USP

CONFIRMATION NO. 5612
POA ACCEPTANCE LETTER

155876
 Peretz Chesal & Herrmann, P.L.
 2 S. Biscayne Blvd., Suite 3700
 Miami, FL 33131



Date Mailed: 08/29/2019

NOTICE OF ACCEPTANCE OF POWER OF ATTORNEY

This is in response to the Power of Attorney filed 08/20/2019.

The Power of Attorney in this application is accepted. Correspondence in this application will be mailed to the above address as provided by 37 CFR 1.33.

Questions about the contents of this notice and the requirements it sets forth should be directed to the Office of Data Management, Application Assistance Unit, at (571) 272-4000 or (571) 272-4200 or 1-888-786-0101.

/sleutchit/

08/20/2019 17:46 PERETZ CHESAL & HERRMANN PL

(FAX)305 371 6807

P.013/018

POWER OF ATTORNEY

08/20/2019 17:46 PERETZ CHESAL & HERRMANN PL

RECEIVED
CENTRAL FAX CENTER

(FAX)305 371 6807

P.014/018

AUG 20 2019

Patent Application No.: 29/625,265

PTO/AIA/98 (07-17)
Approved for use through 01/31/2018, OMB 0851-0035
U.S. Patent and Trademark Office; U.S. DEPARTMENT OF COMMERCE

Under the Paperwork Reduction Act of 1995, no person is required to respond to a collection of information unless it displays a valid OMB control number.

POWER OF ATTORNEY TO PROSECUTE APPLICATIONS BEFORE THE USPTO

I hereby revoke all previous powers of attorney given in the application identified in the attached statement under 37 CFR 3.73(c).

I hereby appoint:

Practitioners associated with Customer Number: 155876

OR

Practitioner(s) named below (if more than ten patent practitioners are to be named, then a customer number must be used):

Name	Registration Number

Name	Registration Number

As attorney(s) or agent(s) to represent the undersigned before the United States Patent and Trademark Office (USPTO) in connection with any and all patent applications assigned only to the undersigned according to the USPTO assignment records or assignment documents attached to this form in accordance with 37 CFR 3.73(c).

Please change the correspondence address for the application identified in the attached statement under 37 CFR 3.73(c) to:

The address associated with Customer Number: 155876

OR

Firm or individual name		
Address		
City	State	Zip
Country		
Telephone	Email	

Assignee name and address: Visit the Assignee List
Quick tabbing 1
TAB-Alt-Down
The above text

A copy of this form, together with a statement under 37 CFR 3.73(c) (Form PTO/AIA/98 or equivalent) is required to be filed in each application in which this form is used. The statement under 37 CFR 3.73(c) may be completed by one of the practitioners appointed in this form, and must identify the application in which this Power of Attorney is to be filed.

SIGNATURE of Assignee of Record

The individual whose signature and title is supplied below is authorized to act on behalf of the assignee.

Signature 	Date August 9 th , 2019
Name P.B.J. Schneider	Telephone +315 262 0926
Title Director	

This collection of information is required by 37 CFR 1.33, 1.33, and 1.38. The information is required to obtain or retain a benefit by the public, which is to update (and by the USPTO to process) the file of a patent or reexamination proceeding. Confidentiality is governed by 35 U.S.C. 122 and 37 CFR 1.11 and 1.14. This collection is estimated to take 18 minutes to complete, including gathering, preparing, and submitting the completed application form to the USPTO. Time will vary depending upon the individual case. Any comments on the amount of time you require to complete this form and/or suggestions for reducing this burden, should be sent to the Chief Information Officer, U.S. Patent and Trademark Office, U.S. Department of Commerce, P.O. Box 1450, Alexandria, VA 22313-1450. DO NOT SEND FEES OR COMPLETED FORMS TO THIS ADDRESS. SEND TO: Commissioner for Patents, P.O. Box 1450, Alexandria, VA 22313-1450.
If you need assistance in completing the form, call 1-800-PTO-9199 and select option 2.

08/20/2019 17:46 PERETZ CHESAL & HERRMANN PL

(FAX)305 371 6807

P.015/018

CREDIT CARD FORMS

08/20/2019 17:46 PERETZ CHESAL & HERRMANN PL

RECEIVED
 CENTRAL FAX CENTER

(FAX)305 371 6807

P.016/018

AUG 20 2019

PTO-2038 (02-2015)

Approved for use through 03/31/2021. OMB 0651-0043
 United States Patent and Trademark Office; U.S. DEPARTMENT OF COMMERCE

Name as it Appears on Credit Card: <u>Steven I Peretz</u>			
Payment Amount (US Dollars): \$ <u>700.00</u>			
Cardholder Signature: <u>Steven I Peretz</u>		Date (mm/dd/yyyy): <u>08/15/2019</u>	
<p>The USPTO does not accept an e-signature (37 CFR 1.4(e)) on credit card payment forms. Refund Policy: The USPTO may refund a fee paid by mistake or in excess of that required. A change of purpose after the payment of a fee will not entitle a party to a refund of such fee. The USPTO will not refund amounts of \$25.00 or less unless a refund is specifically requested and will not notify the payor of such amounts (37 CFR 1.26). Refund of a fee paid by credit card will be issued as a credit to the credit card account to which the fee was charged. Maximum Daily Limit: There is a \$24,999.99 daily limit per credit card account effective June 1, 2015. There is no daily limit for debit cards.</p>			
Credit Card Billing Address			
Street Address 1: <u>2 South Biscayne Blvd</u>			
Street Address 2: <u>Suite 3700</u>			
City: <u>Miami</u>			
State/Province: <u>FL</u>		Zip/Postal Code: <u>33131</u>	
Country: <u>US</u>			
Daytime Phone #: <u>(305) 341-300</u>		Fax #:	
Request and Payment Information			
Description of Request and Payment Information: <u>Issue Fee</u>			
<input checked="" type="checkbox"/> Patent Fee	<input type="checkbox"/> Patent Maintenance Fee	<input type="checkbox"/> Trademark Fee	<input checked="" type="checkbox"/> Other Fee
Application No. <u>29/625,265</u>	Application No.	Application No.	IDON Customer No.
Patent No.	Patent No.	Registration No.	
Attorney Docket No. <u>VVI.001USP</u>		Identify or Describe Mark	

If the cardholder includes a credit card number on any form or document other than the Credit Card Payment Form or submits this form electronically via EFS-Web, the United States Patent and Trademark Office will not be liable in the event that the credit card number becomes public knowledge.

08/20/2019 17:47 PERETZ CHESAL & HERRMANN PL

RECEIVED
 CENTRAL FAX CENTER

(FAX)305 371 6807

P.017/018

AUG 20 2019

PTO-2038 (02-2015)

Approved for use through 03/31/2021. OMB 0651-0043

United States Patent and Trademark Office; U.S. DEPARTMENT OF COMMERCE

Name as it Appears on Credit Card: Steven I. Peretz			
Payment Amount (US Dollars): \$ 140.00			
Cardholder Signature: Steven I. Peretz		Date (mm/dd/yyyy): 08/15/2019	
<p>The USPTO does not accept an e-signature (37 CFR 1.4(e)) on credit card payment forms. Refund Policy: The USPTO may refund a fee paid by mistake or in excess of that required. A change of purpose after the payment of a fee will not entitle a party to a refund of such fee. The USPTO will not refund amounts of \$25.00 or less unless a refund is specifically requested and will not notify the payor of such amounts (37 CFR 1.26). Refund of a fee paid by credit card will be issued as a credit to the credit card account to which the fee was charged. Maximum Daily Limit: There is a \$24,999.99 daily limit per credit card account effective June 1, 2015. There is no daily limit for debit cards.</p>			
Credit Card Billing Address			
Street Address 1: 2 South Biscayne Blvd			
Street Address 2: Suite 3700			
City: Miami			
State/Province: FL		Zip/Postal Code: 33131	
Country: US			
Daytime Phone #: 305-341-3000		Fax #:	
Request and Payment Information			
Description of Request and Payment Information: Corrected Application Data sheet			
<input checked="" type="checkbox"/> Patent Fee	<input type="checkbox"/> Patent Maintenance Fee	<input type="checkbox"/> Trademark Fee	<input checked="" type="checkbox"/> Other Fee
Application No. 29/625,265	Application No.	Application No.	IDON Customer No.
Patent No.	Patent No.	Registration No.	
Attorney Docket No. VVI.001USP		Identify or Describe Mark	

If the cardholder includes a credit card number on any form or document other than the Credit Card Payment Form or submits this form electronically via EFS-Web, the United States Patent and Trademark Office will not be liable in the event that the credit card number becomes public knowledge.

08/20/2019 17:47 PERETZ CHESAL & HERRMANN PL

RECEIVED
 CENTRAL FAX CENTER

(FAX)305 371 6807

P.018/018

AUG 20 2019

PTO-2038 (02-2015)

Approved for use through 03/31/2021. OMB 0651-0043

United States Patent and Trademark Office; U.S. DEPARTMENT OF COMMERCE

Under the Paperwork Reduction Act of 1995

Name as it Appears on Credit Card: Alberto Alvarez			
Payment Amount (US Dollars): \$ 1,700.00			
Cardholder Signature: 		Date (mm/dd/yyyy): 08/15/2019	
<p>The USPTO does not accept an e-signature (37 CFR 1.4(e)) on credit card payment forms. Refund Policy: The USPTO may refund a fee paid by mistake or in excess of that required. A change of purpose after the payment of a fee will not entitle a party to a refund of such fee. The USPTO will not refund amounts of \$25.00 or less unless a refund is specifically requested and will not notify the payor of such amounts (37 CFR 1.26). Refund of a fee paid by credit card will be issued as a credit to the credit card account to which the fee was charged. Maximum Daily Limit: There is a \$24,999.99 daily limit per credit card account effective June 1, 2015. There is no daily limit for debit cards.</p>			
Credit Card Billing Address			
Street Address 1: 10533 SW 99 Ter			
Street Address 2:			
City: Miami			
State/Province: FL		Zip/Postal Code: 33176	
Country:			
Daytime Phone #: 305-341-3000		Fax #:	
Request and Payment Information			
Description of Request and Payment Information: Petition for Revival of Application for Patent Abandoned Unintentionally			
<input checked="" type="checkbox"/> Patent Fee	<input type="checkbox"/> Patent Maintenance Fee	<input type="checkbox"/> Trademark Fee	<input checked="" type="checkbox"/> Other Fee
Application No. 29/625,265	Application No.	Application No.	IDON Customer No.
Patent No.	Patent No.	Registration No.	
Attorney Docket No. VVI.001USP		Identify or Describe Mark	

If the cardholder includes a credit card number on any form or document other than the Credit Card Payment Form or submits this form electronically via EFS-Web, the United States Patent and Trademark Office will not be liable in the event that the credit card number becomes public knowledge.

Document Code: IMIS

Notice of Fee Due

Application Number: 29625265 Date: 08/21/2019

Fees are due for the application or document dated **08/20/2019**. The payment was not collectable for the reason indicated below.

Note: If the fee due is for any of the filing fees, the surcharge for late payment of the filing fees is now due as well.

- Insufficient payment by check or money order.
- No authorization to charge a deposit account. PAR-ELE.004DS
- Invalid deposit account number.
- User name not listed in deposit account _____ at _____ (time).
- Insufficient funds in deposit account _____ at _____ (time).
- Insufficient payment by credit card.
-
- Declined credit card _____ AM (time).

Fee code(s) to be applied:	<u>1353</u>	<u>\$ 2000.00</u>
	_____	\$ _____
	_____	\$ _____
	_____	\$ _____
	_____	\$ _____
Amount in holding fee code:	<u>1506</u>	<u>\$ _____</u>
	<u>1622/2622</u>	<u>\$ _____</u>
	<u>1206/2206</u>	<u>\$ _____</u>
	<u>1999</u>	<u>\$ 1700.00</u>
<u>Total remaining due from applicant:</u>		<u>\$ 300.00</u>

RAM Operator: ST

08/20/2019 17:43 PERETZ CHESAL & HERRMANN PL

(FAX)305 371 6807

P.001/018

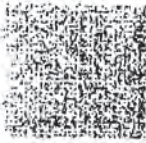
Peretz
Chesal
Herrmann

1 SOUTH BISCAYNE BLVD | STE 3700 | MIAMI FL 33131 | T. 305.341.3000 | F. 305.371.6807 | PCH-IP.LAW.COM

INTELLECTUAL PROPERTY LAWYERS

RECEIVED
CENTRAL FAX CENTER

AUG 20 2019

FAX COVER SHEET

August 20, 2019

To: U.S. Patent Office	Fax: 571-273-8300
From: Erika Montane Legal Assistant for Alberto Alvarez, Esq.	Phone: 305-341-3000
Re: Patent Application No. 29/625,265	

Number of Pages: 18 including this cover page. If you do not receive all of the pages, please call our operator at (305) 341-3000 as soon as possible. If you do not call, we will assume that all pages were received.

COMMENTS:

Attached please find the following documents in connection with the above patent application:

1. Petition for Revival of an Application for Patent Abandonment Unintentionally Under 37 CFR 1.137(a);
2. Statement in Support of Petition for Revival of an Application for Patent Abandonment Unintentionally Under 37 CFR 1.137(a);
3. Corrected Application Data Sheet;
4. Power of Attorney; and
5. Three (3) credit card authorization forms.

08/20/2019 17:44 PERETZ CHESAL & HERRMANN PL

(FAX)305 371 6807

P.002/018

**PETITION FOR REVIVAL OF APPLICATION FOR PATENT
ABANDONMENT UNINTENTIONALLY UNDER 37 CFR 1.137(A)**

08/20/2019 17:44 PERETZ CHESAL & HERRMANN PL

RECEIVED
CENTRAL FAX CENTER

(FAX) 305 371 6807

P.003/018

AUG 20 2019

Doc Code: PET.OP

Document Description: Petition for Review by the Office of Petitions

PTO/SB/64 (01-18)

Approved for use through 11/30/2020. OMB 065J-0091

U.S. Patent and Trademark Office; U.S. DEPARTMENT OF COMMERCE

Under the Paperwork Reduction Act of 1995, no persons are required to respond to a collection of information unless it displays a valid OMB control number.

<p>PETITION FOR REVIVAL OF AN APPLICATION FOR PATENT ABANDONED UNINTENTIONALLY UNDER 37 CFR 1.137(a)</p> <p>Page 1 of 2</p>	<p>Docket Number (Optional) VVI.001USP</p>
<p>First named inventor: <u>Rui Medeiros Santos</u></p>	
<p>Application No.: <u>29/625,265</u></p>	<p>Art Unit: <u>2912</u></p>
<p>Filed: <u>11/08/2017</u></p>	<p>Examiner: <u>Janice Julia Patyk</u></p>
<p>Title: UTENSIL REST</p>	
<p>Attention: Office of Petitions Mail Stop Petition Commissioner for Patents P.O. Box 1450 Alexandria, VA 22313-1450 FAX (571) 273-8300</p>	
<p>NOTE: If information or assistance is needed in completing this form, please contact the Office of Petitions at (571) 272-3282.</p> <p>The above-identified application became abandoned for failure to file a timely and proper reply to a notice or action by the United States Patent and Trademark Office. The date of abandonment is the day after the expiration date of the period set for reply in the Office notice or action plus any extensions of time actually obtained.</p> <p>APPLICANT HEREBY PETITIONS FOR REVIVAL OF THIS APPLICATION.</p> <p>NOTE: A grantable petition requires the following items:</p> <ol style="list-style-type: none"> (1) Petition fee; (2) Reply and/or issue fee; (3) Terminal disclaimer with disclaimer fee - required for all utility and plant applications filed before June 8, 1995, and for all design applications; and (4) Statement that the entire delay was unintentional. 	
<p>1. Petition fee</p> <p><input type="checkbox"/> Small entity fee \$ _____ (37 CFR 1.17(m)). Applicant asserts small entity status. See 37 CFR 1.27.</p> <p><input type="checkbox"/> Micro entity fee \$ _____ (37 CFR 1.17(m)). Applicant certifies micro entity status. See 37 CFR 1.29. Form PTO/SB/15A or B or equivalent must either be enclosed or have been submitted previously.</p> <p><input checked="" type="checkbox"/> Undiscounted fee \$ <u>1,700.00</u> (37 CFR 1.17(m)).</p>	
<p>2. Reply and/or fee</p> <p>A The reply and/or fee to the above-noted Office notice or action in the form of _____ (Identify the type of reply):</p> <p><input type="checkbox"/> has been filed previously on _____</p> <p><input checked="" type="checkbox"/> is enclosed herewith.</p> <p>B The issue fee and publication fee (if applicable) of \$ <u>700</u></p> <p><input type="checkbox"/> has been paid previously on _____</p> <p><input checked="" type="checkbox"/> is enclosed herewith.</p>	

This collection of information is required by 37 CFR 1.137(b). The information is required to obtain or retain a benefit by the public which is to file (and by the USPTO to process) an application. Confidentiality is governed by 35 U.S.C. 122 and 37 CFR 1.11, 1.14 and 41.6. This collection is estimated to take 1 hour to complete, including gathering, preparing, and submitting the completed application form to the USPTO. Time will vary depending upon the individual case. Any comments on the amount of time you require to complete this form and/or suggestions for reducing this burden, should be sent to the Chief Information Officer, U.S. Patent and Trademark Office, U.S. Department of Commerce, P.O. Box 1450, Alexandria, VA 22313-1450. DO NOT SEND FEES OR COMPLETED FORMS TO THIS ADDRESS. SEND TO: Mail Stop Petition, Commissioner for Patents, P.O. Box 1450, Alexandria, VA 22313-1450.

If you need assistance in completing the form, call 1-800-PTO-9199 and select option 2.

08/20/2019 17:45 PERETZ CHESAL & HERRMANN PL

RECEIVED
CENTRAL FAX CENTER

(FAX)305 371 6807

P.004/018

AUG 20 2019

Doc Code: PET.OP

Document Description: Petition for Review by the Office of Petitions

PTO/SB/64 (01-18)

Approved for use through 11/30/2020. OMB 0651-0031
U.S. Patent and Trademark Office; U.S. DEPARTMENT OF COMMERCE

Under the Paperwork Reduction Act of 1995, no persons are required to respond to a collection of information unless it displays a valid OMB control number.

**PETITION FOR REVIVAL OF AN APPLICATION FOR PATENT
ABANDONED UNINTENTIONALLY UNDER 37 CFR 1.137(a)**

Page 2 of 2

3. Terminal disclaimer with disclaimer fee

- Since this utility/plant application was filed on or after June 8, 1995, no terminal disclaimer is required.
- A terminal disclaimer (and disclaimer fee (37 CFR 1.20(d)) of \$ _____) disclaiming the required period of time is enclosed herewith (see PTO/SB/63).

4. STATEMENT: The entire delay in filing the required reply from the due date for the required reply until the filing of a grantable petition under 37 CFR 1.137(a) was unintentional. [NOTE: The United States Patent and Trademark Office may require additional information if there is a question as to whether either the abandonment or the delay in filing a petition under 37 CFR 1.137(a) was unintentional (MPEP 711.03(c), subsections (III)(C) and (D)).]

WARNING:

Petitioner/applicant is cautioned to avoid submitting personal information in documents filed in a patent application that may contribute to identity theft. Personal information such as social security numbers, bank account numbers, or credit card numbers (other than a check or credit card authorization form PTO-2038 submitted for payment purposes) is never required by the USPTO to support a petition or an application. If this type of personal information is included in documents submitted to the USPTO, petitioners/applicants should consider redacting such personal information from the documents before submitting them to the USPTO. Petitioner/applicant is advised that the record of a patent application is available to the public after publication of the application (unless a non-publication request in compliance with 37 CFR 1.213(a) is made in the application) or issuance of a patent. Furthermore, the record from an abandoned application may also be available to the public if the application is referenced in a published application or an issued patent (see 37 CFR 1.14). Checks and credit card authorization forms PTO-2038 submitted for payment purposes are not retained in the application file and therefore are not publicly available.

s/alberto alvarez/

Signature

8/20/2019

Date

Alberto Alvarez

Typed or Printed Name

69260

Registration Number, if applicable

2 South Biscayne Blvd. # 3700

Address

305-341-3000

Telephone Number

Miami, FL 33131

Address

Enclosures:

- Fee Payment
- Reply
- Terminal Disclaimer Form
- Additional sheet(s) containing statements establishing unintentional delay
- Other: _____

CERTIFICATE OF MAILING OR TRANSMISSION [37 CFR 1.8(a)]

I hereby certify that this correspondence is being:

- Deposited with the United States Postal Service on the date shown below with sufficient postage as first class mail in an envelope addressed to: Mail Stop Petition, Commissioner for Patents, P. O. Box 1450, Alexandria, VA 22313-1450.
- Transmitted by facsimile on the date shown below to the United States Patent and Trademark Office at (571) 273-8300.

8/20/2019

Date

s/alberto alvarez/

Signature

Alberto Alvarez

Typed or printed name of person signing certificate

08/20/2019 17:45 PERETZ CHESAL & HERRMANN PL

(FAX)305 371 6807

P.005/018

**STATEMENT IN SUPPORT OF PETITION FOR REVIVAL OF
APPLICATION FOR PATENT ABANDONMENT UNINTENTIONALLY
UNDER 37 CFR 1.137(A)**

08/20/2019 17:45 PERETZ CHESAL & HERRMANN PL

RECEIVED
CENTRAL FAX CENTER

(FAX)305 371 6807

P.006/018

AUG 20 2019

STATEMENT
Application No.: 29/625,265
Group Art Unit: 2912
Filing Date: November 8, 2017
Examiner Janice Julia Patyk
Attorney Docket No.: VVI.001USP**IN THE UNITED STATES PATENT AND TRADEMARK OFFICE**

Application Number: 29/625,265
Confirmation No.: 5612
Filing Date: November 8, 2017
Applicant: Vacu Vin Innovations Ltd.
Entitled: UTENSIL REST
Examiner: Janice Julia Patyk
Group Art Unit: 2912
Attorney Docket No.: VVI.001USP

STATEMENT IN SUPPORT OF PETITION FOR REVIVAL OF APPLICATION FOR PATENT ABANDONMENT UNINTENTIONALLY UNDER 37 CFR 1.137(a)

Commissioner for Patents,
P.O. Box 1450, Alexandria, Virginia 22313-1450
Facsimile: (571) 273-8300

Dear Commissioner:

In response to the Notice of Abandonment dated July 31, 2019 in the above-captioned application, please be advised that the delay for the payment of the Issue Fee was entirely unintentional and due to the following reason:

1. The undersigned's law firm's former patent attorney, Joseph Englander, left the law firm to join another firm and accordingly updated the contact information associated with his customer number. After leaving the undersigned's law firm, Mr. Englander no longer represented the applicants.
2. A Notice of Allowance was issued by the USPTO on April 15, 2019. Because the Notice of Allowance was forwarded to Mr. Englander's new law firm, the undersigned

08/20/2019 17:45 PERETZ CHESAL & HERRMANN PL

(FAX)305 371 6807

P.007/018

STATEMENT
Application No.: 29/625,265
Group Art Unit: 2912
Filing Date: November 8, 2017
Examiner Janice Julia Patyk
Attorney Docket No.: VV1.001USP

and the applicant did not receive and were not aware of the Notice of Allowance.

3. On August 2, 2019, Mr. Englander forwarded to the undersigned the Notice of Abandonment for failure to pay the Issue Fee by the deadline.

4. The delay in payment of the Issue Fee was not in any way the fault of the applicant, and revival of the application and acceptance of the issue fee would serve the interests of fairness and justice.

5. Together with the Petition for Revival of an Application for Patent Abandoned Unintentionally Under 37 CFR 1.137(a), the undersigned is submitting:

- a. a corrected Application Data Sheet to correct the name of one of the inventors (a notice advising the applicant of a defect in the oath of one of the inventors was issued by the USPTO on June 25, 2019);
- b. an executed Power of Attorney associated with the undersigned's customer number;
- c. payment of the Issue Fee;
- d. payment of the fee for the corrected Application Data Sheet; and
- e. payment of all other fees required in connection with the Petition for Revival of an Application for Patent Abandoned Unintentionally Under 37 CFR 1.137(a).

6. Accordingly, the undersigned respectfully requests that the application be revived and that the USPTO accept applicant's corrected Application Data Sheet and Issue Fee.

Dated August 20, 2019

Respectfully submitted,

s/Alberto Alvarez
Alberto Alvarez (Reg. No. 69260)
Peretz Chesal & Herrmann, P.L.
2 S. Biscayne Blvd., Suite 3700
Miami, Florida 33131
T: 305-341-3000
aalvarez@pch-iplaw.com/patents@pch-iplaw.com

08/20/2019 17:45 PERETZ CHESAL & HERRMANN PL

(FAX)305 371 6807

P.008/018

CORRECTED APPLICATION DATA SHEET

08/20/2019 17:45 PERETZ CHESAL & HERRMANN PL

RECEIVED
 CENTRAL FAX CENTER

(FAX) 305 371 6807

P.009/018

AUG 20 2019

PTO/AJ/14 (11-16)

Approved for use through 04/30/2017. OMB 0851-0032
 U.S. Patent and Trademark Office; U.S. DEPARTMENT OF COMMERCE

Under the Paperwork Reduction Act of 1995, no persons are required to respond to a collection of information unless it contains a valid OMB control number.

Application Data Sheet 37 CFR 1.76		Attorney Docket Number	WI.001USP
		Application Number	
Title of Invention	UTENSIL REST		
The application data sheet is part of the provisional or nonprovisional application for which it is being submitted. The following form contains the bibliographic data arranged in a format specified by the United States Patent and Trademark Office as outlined in 37 CFR 1.76. This document may be completed electronically and submitted to the Office in electronic format using the Electronic Filing System (EFS) or the document may be printed and included in a paper filed application.			

Secrecy Order 37 CFR 5.2:

Portions or all of the application associated with this Application Data Sheet may fall under a Secrecy Order pursuant to 37 CFR 5.2 (Paper filers only. Applications that fall under Secrecy Order may not be filed electronically.)

Inventor Information:

Inventor 1				
Legal Name				
Prefix	Given Name	Middle Name	Family Name	Suffix
	Rui	Medeiros	Medeiros Santos	
Residence Information (Select One) <input type="radio"/> US Residency <input checked="" type="radio"/> Non US Residency <input type="radio"/> Active US Military Service				
City	Rotterdam	Country of Residence	NL	
Mailing Address of Inventor:				
Address 1	Waasbloem 18			
Address 2				
City	Rotterdam	State/Province		
Postal Code	3068 AT	Country	NL	
Inventor 2				
Legal Name				
Prefix	Given Name	Middle Name	Family Name	Suffix
	Sandra		van Oosterbaan-Rijnen	
Residence Information (Select One) <input type="radio"/> US Residency <input checked="" type="radio"/> Non US Residency <input type="radio"/> Active US Military Service				
City	Barendrecht	Country of Residence	NL	
Mailing Address of Inventor:				
Address 1	Boeler 93			
Address 2				
City	Barendrecht	State/Province		
Postal Code	2991 KE	Country	NL	
Inventor 3				
Legal Name				

EFS Web 2.2.12

08/20/2019 17:45 PERETZ CHESAL & HERRMANN PL

(FAX)305 371 6807

P.010/018

PTO/AIA/14 (11-15)





Approved for use through 04/30/2017. OMB 0851-0032

U.S. Patent and Trademark Office; U.S. DEPARTMENT OF COMMERCE

Under the Paperwork Reduction Act of 1995, no persons are required to respond to a collection of information unless it contains a valid OMB control number.

Application Data Sheet 37 CFR 1.76		Attorney Docket Number	VI.001USP	
		Application Number		
Title of Invention	UTENSIL REST			
Prefix	Given Name	Middle Name	Family Name	Suffix
	Delphine		Buyse	
Residence Information (Select One) <input type="radio"/> US Residency <input checked="" type="radio"/> Non US Residency <input type="radio"/> Active US Military Service				
City	Voorburg	Country of Residence	NL	
Mailing Address of Inventor:				
Address 1	Van Halowijnlaan 167			
Address 2				
City	Voorburg	State/Province		
Postal Code	2274 TG	Country	NL	
All Inventors Must Be Listed - Additional Inventor Information blocks may be generated within this form by selecting the Add button.				

Correspondence Information:

Enter either Customer Number or complete the Correspondence Information section below. For further information see 37 CFR 1.33(a).			
<input type="checkbox"/> An Address is being provided for the correspondence information of this application.			
Customer Number	139305		
Email Address	patents@poh-iplaw.com		
Email Address	jenglander@poh-iplaw.com		

Application Information:

Title of the Invention	UTENSIL REST		
Attorney Docket Number	VI.001USP	Small Entity Status Claimed	<input type="checkbox"/>
Application Type	Nonprovisional		
Subject Matter	Design		
Total Number of Drawing Sheets (if any)	7	Suggested Figure for Publication (if any)	1
Filing By Reference:			
Only complete this section when filing an application by reference under 35 U.S.C. 111(c) and 37 CFR 1.57(a). Do not complete this section if application papers including a specification and any drawings are being filed. Any domestic benefit or foreign priority information must be provided in the appropriate section(s) below (i.e., "Domestic Benefit/National Stage Information" and "Foreign Priority Information").			
For the purposes of a filing date under 37 CFR 1.53(b), the description and any drawings of the present application are replaced by this			
Application number of the previously filed application	Filing date (YYYY-MM-DD)	Intellectual Property Authority or Country	

EF9 Web 2.2.12

08/20/2019 17:46 PERETZ CHESAL & HERRMANN PL

(FAX)305 371 6807

P.011/018

PTO/AIA/14 (11-15)

Approved for use through 04/30/2017. OMB 0851-0032

U.S. Patent and Trademark Office; U.S. DEPARTMENT OF COMMERCE

Under the Paperwork Reduction Act of 1995, no persons are required to respond to a collection of information unless it contains a valid OMB control number.

Application Data Sheet 37 CFR 1.76		Attorney Docket Number	VVI.001USP
		Application Number	
Title of Invention	UTENSIL REST		

Publication Information:

<input type="checkbox"/>	Request Early Publication (Fee required at time of Request 37 CFR 1.219)
<input type="checkbox"/>	Request Not to Publish. I hereby request that the attached application not be published under 35 U.S.C. 122(b) and certify that the invention disclosed in the attached application has not and will not be the subject of an application filed in another country, or under a multilateral international agreement, that requires publication at eighteen months after filing.

Representative Information:

Representative information should be provided for all practitioners having a power of attorney in the application. Providing this information in the Application Data Sheet does not constitute a power of attorney in the application (see 37 CFR 1.32). Either enter Customer Number or complete the Representative Name section below. If both sections are completed the customer number will be used for the Representative Information during processing.			
Please Select One:			
<input checked="" type="radio"/>	Customer Number	<input type="radio"/>	US Patent Practitioner
<input type="radio"/>		<input type="radio"/>	Limited Recognition (37 CFR 11.9)
Customer Number	139305		

Domestic Benefit/National Stage Information:

This section allows for the applicant to either claim benefit under 35 U.S.C. 119(e), 120, 121, 365(c), or 386(c) or indicate National Stage entry from a PCT application. Providing benefit claim information in the Application Data Sheet constitutes the specific reference required by 35 U.S.C. 119(e) or 120, and 37 CFR 1.78. When referring to the current application, please leave the "Application Number" field blank.

Prior Application Status			
Application Number	Continuity Type	Prior Application Number	Filing or 371(c) Date (YYYY-MM-DD)
Additional Domestic Benefit/National Stage Data may be generated within this form by selecting the Add button.			

Foreign Priority Information:

This section allows for the applicant to claim priority to a foreign application. Providing this information in the application data sheet constitutes the claim for priority as required by 35 U.S.C. 119(b) and 37 CFR 1.65. When priority is claimed to a foreign application that is eligible for retrieval under the priority document exchange program (PDX), the information will be used by the Office to automatically attempt retrieval pursuant to 37 CFR 1.65(i)(1) and (2). Under the PDX program, applicant bears the ultimate responsibility for ensuring that a copy of the foreign application is received by the Office from the participating foreign intellectual property office, or a certified copy of the foreign priority application is filed, within the time period specified in 37 CFR 1.65(g)(1).

EFS Web 2.2.12

08/20/2019 17:46 PERETZ CHESAL & HERRMANN PL

(FAX)305 371 6807

P.012/018

PTO/AIA/14 (11-15)

Approved for use through 04/30/2017. OMB 0861-0032

U.S. Patent and Trademark Office; U.S. DEPARTMENT OF COMMERCE

Under the Paperwork Reduction Act of 1995, no persons are required to respond to a collection of information unless it contains a valid OMB control number.

Application Data Sheet 37 CFR 1.76		Attorney Docket Number	VVI.001USP
		Application Number	
Title of Invention	UTENSIL REST		
Application Number	Country ¹	Filing Date (YYYY-MM-DD)	Access Code ² (if applicable)
Additional Foreign Priority Data may be generated within this form by selecting the Add button.			

Statement under 37 CFR 1.55 or 1.78 for AIA (First Inventor to File) Transition Applications

<p>This application (1) claims priority to or the benefit of an application filed before March 16, 2013 and (2) also contains, or contained at any time, a claim to a claimed invention that has an effective filing date on or after March 16, 2013.</p> <p><input type="checkbox"/> NOTE: By providing this statement under 37 CFR 1.55 or 1.78, this application, with a filing date on or after March 16, 2013, will be examined under the first inventor to file provisions of the AIA.</p>
--

EFS Web 2.2.12



UNITED STATES PATENT AND TRADEMARK OFFICE

UNITED STATES DEPARTMENT OF COMMERCE
 United States Patent and Trademark Office
 Address: COMMISSIONER FOR PATENTS
 P.O. Box 1450
 Alexandria, Virginia 22313-1450
 www.uspto.gov

APPLICATION NO.	FILING DATE	FIRST NAMED INVENTOR	ATTORNEY DOCKET NO.	CONFIRMATION NO.
29/625,265	11/08/2017	Rui Medeiros	VVI.001USP	5612
7590 07/31/2019				
Fowler White Burnett, P.A. 1395 Brickell Avenue, 14th Floor Miami, FL 33131				
EXAMINER				
PATYK, JANICE JULIA				
		ART UNIT		
		PAPER NUMBER		
2912				
		NOTIFICATION DATE		DELIVERY MODE
		07/31/2019		ELECTRONIC

Notice of Abandonment

This application is abandoned in view of:

- The applicant's failure to timely file a proper reply to the Office letter mailed on _____.
 - A reply was received on _____ (with a Certificate of Mailing or Transmission date _____), which is after the expiration of the period for reply (including a total extension of ____ month(s)) which expired on _____.
 - No reply has been received.
- Applicant's failure to timely pay the required issue fee and publication fee, if applicable, within the statutory period of three months from the mailing date of the Notice of Allowance (PTOL-85).
 - The issue fee and publication fee, if applicable, was received on _____ (with a Certificate of Mailing or Transmission date _____), which is after the expiration of the statutory period for payment of the issue fee (and publication fee) set in the Notice of Allowance (PTOL-85).
 - The submitted fee of \$ _____ is insufficient. A balance of \$ _____ is due.
 The issue fee required by 37 CFR 1.18 is \$ _____.
 The publication fee, if required by 37 CFR 1.18(d), is \$ _____.
 - The issue fee and publication fee, if applicable, has not been received.
- Applicant's failure to timely file corrected drawings as required by, and within the three-month period set in, the Notice of Allowability (PTO-37).
 - Proposed corrected drawings were received on _____ (with a Certificate of Mailing or Transmission dated _____), which is after the expiration of the period for reply.
 - No corrected drawing have been received.
- Applicant's failure to timely file the inventor's oath or declaration no later than the date on which the issue fee was paid as required by the Notice Requiring Inventor's Oath or Declaration (PTO-2306).
 - An inventor's oath or declaration was received on _____ (with a Certificate of Mailing or Transmission date _____), which is after the date on which the issue fee was paid.
 - While an oath or declaration (or substitute statement) for one or more inventors was received, an oath or declaration (or substitute statement) for at least one other inventor has not been received.
 - No inventor's oath or declaration has been received.
- Drawings received on _____ were disapproved by examiner. See examiner's response dated _____.
- Corrected drawings were received on _____, which is after the expiration of the one-month period for reply set in examiner's response dated _____.
- No corrected drawings have been received in reply to one-month period set in examiner's response dated _____.
- The reason(s) below:

Petitions to revive under 37 CFR 1.137(a) or request to withdraw the holding of abandonment under 37 CFR 1.181, should be promptly filed to minimize any negative effects on patent term.

Dr. Ayley for
 (571)-272-4200 or 1(888)-786-0101
 Patent Publication Branch
 Office of Data Management
 FORM PTO-ABN0 (Rev. 03/17)



UNITED STATES PATENT AND TRADEMARK OFFICE

 UNITED STATES DEPARTMENT OF COMMERCE
 United States Patent and Trademark Office
 Address: COMMISSIONER FOR PATENTS
 P.O. Box 1450
 Alexandria, Virginia 22313-1450
 www.uspto.gov

APPLICATION NO.	FILING DATE	FIRST NAMED INVENTOR	ATTORNEY DOCKET NO.	CONFIRMATION NO.
29/625,265	11/08/2017	Rui Medeiros	VVI.001USP	5612
7590 06/25/2019				
Fowler White Burnett, P.A. 1395 Brickell Avenue, 14th Floor Miami, FL 33131		EXAMINER PATYK, JANICE JULIA		
		ART UNIT PAPER NUMBER		
		2912		
		NOTIFICATION DATE DELIVERY MODE		
		06/25/2019 ELECTRONIC		

NOTICE REQUIRING INVENTOR'S OATH OR DECLARATION

An inventor's oath or declaration in compliance with 37 CFR 1.63 or substitute statement in compliance with 37 CFR 1.64 executed by or with respect to each inventor has not yet been submitted.

The inventor's oath or declaration or substitute statement dated 11/08/2017 is defective. The inventor's oath or declaration does not comply with 37 CFR 1.63 or the substitute statement does not comply with 37 CFR 1.64 because it:

- does not include a statement that the person executing the oath or declaration or substitute statement believes the named inventor or joint inventor to be the original inventor or an original joint inventor of a claimed invention in the application for which the oath or declaration is being submitted.
- does not state that the application was made or was authorized to be made by the person executing the oath or declaration or substitute statement.
- does not acknowledge that any willful false statement made in such oath or declaration or substitute statement is punishable under section 1001 of title 18 by fine or imprisonment of not more than 5 years, or both.
- does not identify the person executing the oath or declaration or substitute statement by his or her legal name.
- does not identify the application to which the oath or declaration or substitute statement is directed.
- Other: A properly executed OATH/DECLARATION or SUBSTITUTE STATEMENT for the following Inventor(s) has not been received: Rui MEDEIROS

The substitute statement dated _____ does not comply with 37 CFR 1.64 because it:

- does not identify the inventor with respect to whom the statement applies.
- does not identify the relationship to the non-signing inventor.
- does not identify the circumstances permitting execution of the statement.
- was signed by someone other than the applicant.
- Other: _____

An oath or declaration in compliance with 37 CFR 1.63, or a substitute statement in compliance with 37 CFR 1.64, executed by or with respect to each inventor MUST be filed no later than the date on which the issue fee is paid. See 35 U.S.C. 115(f). Failure to timely comply will result in ABANDONMENT of this application. This period for reply is not extendable under 37 CFR 1.136(a).

Questions relating to this Notice should be directed to the Application Assistance Unit at 571-272-4200.

(571)-272-4200 or 1(888)-786-0101
 Patent Publication Branch
 Office of Data Management



UNITED STATES PATENT AND TRADEMARK OFFICE

UNITED STATES DEPARTMENT OF COMMERCE
 United States Patent and Trademark Office
 Address: COMMISSIONER FOR PATENTS
 P.O. Box 1450
 Alexandria, Virginia 22313-1450
 www.uspto.gov

APPLICATION NUMBER	FILING or 371(c) DATE	GRP ART UNIT	FIL FEE REC'D	ATTY. DOCKET NO	TOT CLAIMS	IND CLAIMS
29/625,265	11/08/2017	2912	760	VVL001USP	1	1

139305
 Fowler White Burnett, P.A.
 1395 Brickell Avenue, 14th Floor
 Miami, FL 33131

CONFIRMATION NO. 5612
CORRECTED FILING RECEIPT



Date Mailed: 06/24/2019

Receipt is acknowledged of this non-provisional design patent application. The application will be taken up for examination in due course. Applicant will be notified as to the results of the examination. Any correspondence concerning the application must include the following identification information: the U.S. APPLICATION NUMBER, FILING DATE, NAME OF FIRST INVENTOR, and TITLE OF INVENTION. Fees transmitted by check or draft are subject to collection.

Please verify the accuracy of the data presented on this receipt. If an error is noted on this Filing Receipt, please submit a written request for a corrected Filing Receipt, including a properly marked-up ADS showing the changes with strike-through for deletions and underlining for additions. If you received a "Notice to File Missing Parts" or other Notice requiring a response for this application, please submit any request for correction to this Filing Receipt with your reply to the Notice. When the USPTO processes the reply to the Notice, the USPTO will generate another Filing Receipt incorporating the requested corrections provided that the request is grantable.

Inventor(s)

Rui Medeiros, Rotterdam, NETHERLANDS;
 Sandra van Oosterbaan-Rijnen, Barendrecht, NETHERLANDS;
 Delphine Buyse, Voorburg, NETHERLANDS;

Applicant(s)

Vacu Vin Innovations Ltd., Delfgauw, NETHERLANDS;

Power of Attorney: The patent practitioners associated with Customer Number 139305

Domestic Applications for which benefit is claimed - None.

A proper domestic benefit claim must be provided in an Application Data Sheet in order to constitute a claim for domestic benefit. See 37 CFR 1.76 and 1.78.

Foreign Applications for which priority is claimed (You may be eligible to benefit from the **Patent Prosecution Highway** program at the USPTO. Please see <http://www.uspto.gov> for more information.) - None.

Foreign application information must be provided in an Application Data Sheet in order to constitute a claim to foreign priority. See 37 CFR 1.55 and 1.76.

Permission to Access Application via Priority Document Exchange: No

Permission to Access Search Results: Yes

Applicant may provide or rescind an authorization for access using Form PTO/SB/39 or Form PTO/SB/69 as appropriate.

If Required, Foreign Filing License Granted: 11/09/2017

The country code and number of your priority application, to be used for filing abroad under the Paris Convention, is **US 29/625,265**

Projected Publication Date: None, application is not eligible for pre-grant publication

Non-Publication Request: No

Early Publication Request: No
Title

UTENSIL REST

Preliminary Class

D07

Statement under 37 CFR 1.55 or 1.78 for AIA (First Inventor to File) Transition Applications: No

PROTECTING YOUR INVENTION OUTSIDE THE UNITED STATES

Since the rights granted by a U.S. patent extend only throughout the territory of the United States and have no effect in a foreign country, an inventor who wishes patent protection in another country must apply for a patent in a specific country or in regional patent offices. Applicants may wish to consider the filing of an international application under the Patent Cooperation Treaty (PCT). An international (PCT) application generally has the same effect as a regular national patent application in each PCT-member country. The PCT process **simplifies** the filing of patent applications on the same invention in member countries, but **does not result** in a grant of "an international patent" and does not eliminate the need of applicants to file additional documents and fees in countries where patent protection is desired.

Almost every country has its own patent law, and a person desiring a patent in a particular country must make an application for patent in that country in accordance with its particular laws. Since the laws of many countries differ in various respects from the patent law of the United States, applicants are advised to seek guidance from specific foreign countries to ensure that patent rights are not lost prematurely.

Applicants also are advised that in the case of inventions made in the United States, the Director of the USPTO must issue a license before applicants can apply for a patent in a foreign country. The filing of a U.S. patent application serves as a request for a foreign filing license. The application's filing receipt contains further information and guidance as to the status of applicant's license for foreign filing.

Applicants may wish to consult the USPTO booklet, "General Information Concerning Patents" (specifically, the section entitled "Treaties and Foreign Patents") for more information on timeframes and deadlines for filing foreign patent applications. The guide is available either by contacting the USPTO Contact Center at 800-786-9199, or it can be viewed on the USPTO website at <http://www.uspto.gov/web/offices/pac/doc/general/index.html>.

For information on preventing theft of your intellectual property (patents, trademarks and copyrights), you may wish to consult the U.S. Government website, <http://www.stopfakes.gov>. Part of a Department of Commerce initiative, this website includes self-help "toolkits" giving innovators guidance on how to protect intellectual property in specific

countries such as China, Korea and Mexico. For questions regarding patent enforcement issues, applicants may call the U.S. Government hotline at 1-866-999-HALT (1-866-999-4258).

**LICENSE FOR FOREIGN FILING UNDER
Title 35, United States Code, Section 184
Title 37, Code of Federal Regulations, 5.11 & 5.15**

GRANTED

The applicant has been granted a license under 35 U.S.C. 184, if the phrase "IF REQUIRED, FOREIGN FILING LICENSE GRANTED" followed by a date appears on this form. Such licenses are issued in all applications where the conditions for issuance of a license have been met, regardless of whether or not a license may be required as set forth in 37 CFR 5.15. The scope and limitations of this license are set forth in 37 CFR 5.15(a) unless an earlier license has been issued under 37 CFR 5.15(b). The license is subject to revocation upon written notification. The date indicated is the effective date of the license, unless an earlier license of similar scope has been granted under 37 CFR 5.13 or 5.14.

This license is to be retained by the licensee and may be used at any time on or after the effective date thereof unless it is revoked. This license is automatically transferred to any related applications(s) filed under 37 CFR 1.53(d). This license is not retroactive.

The grant of a license does not in any way lessen the responsibility of a licensee for the security of the subject matter as imposed by any Government contract or the provisions of existing laws relating to espionage and the national security or the export of technical data. Licensees should apprise themselves of current regulations especially with respect to certain countries, of other agencies, particularly the Office of Defense Trade Controls, Department of State (with respect to Arms, Munitions and Implements of War (22 CFR 121-128)); the Bureau of Industry and Security, Department of Commerce (15 CFR parts 730-774); the Office of Foreign Assets Control, Department of Treasury (31 CFR Parts 500+) and the Department of Energy.

NOT GRANTED

No license under 35 U.S.C. 184 has been granted at this time, if the phrase "IF REQUIRED, FOREIGN FILING LICENSE GRANTED" DOES NOT appear on this form. Applicant may still petition for a license under 37 CFR 5.12, if a license is desired before the expiration of 6 months from the filing date of the application. If 6 months has lapsed from the filing date of this application and the licensee has not received any indication of a secrecy order under 35 U.S.C. 181, the licensee may foreign file the application pursuant to 37 CFR 5.15(b).

SelectUSA

The United States represents the largest, most dynamic marketplace in the world and is an unparalleled location for business investment, innovation, and commercialization of new technologies. The U.S. offers tremendous resources and advantages for those who invest and manufacture goods here. Through SelectUSA, our nation works to promote and facilitate business investment. SelectUSA provides information assistance to the international investor community; serves as an ombudsman for existing and potential investors; advocates on behalf of U.S. cities, states, and regions competing for global investment; and counsels U.S. economic development organizations on investment attraction best practices. To learn more about why the United States is the best country in the world to develop

technology, manufacture products, deliver services, and grow your business, visit <http://www.SelectUSA.gov> or call +1-202-482-6800.

UNITED STATES PATENT AND TRADEMARK OFFICE
COMMISSIONER FOR PATENTS
P.O. BOX 1450
ALEXANDRIA VA 22313-1451

PRESORTED
FIRST-CLASS MAIL
U.S. POSTAGE PAID
POSTEDIGITAL
NNNNN

Fowler White Burnett, P.A.
1395 Brickell Avenue, 14th Floor
Miami, FL 33131



**Courtesy Reminder for
Application Serial No: 29/625,265**

Attorney Docket No: VVI.001USP

Customer Number: 139305

Date of Electronic Notification: 04/15/2019

This is a courtesy reminder that new correspondence is available for this application. If you have not done so already, please review the correspondence. The official date of notification of the outgoing correspondence will be indicated on the form PTOL-90 accompanying the correspondence.

An email notification regarding the correspondence was sent to the following email address(es) associated with your customer number:

JEnglander@fowler-white.com

To view your correspondence online or update your email addresses, please visit us anytime at <https://ppair-my.uspto.gov/pair/PrivatePair>.

If you have any questions, please email the Electronic Business Center (EBC) at EBC@uspto.gov or call 1-866-217-9197.



UNITED STATES PATENT AND TRADEMARK OFFICE

UNITED STATES DEPARTMENT OF COMMERCE
 United States Patent and Trademark Office
 Address: COMMISSIONER FOR PATENTS
 P.O. Box 1450
 Alexandria, Virginia 22313-1450
 www.uspto.gov

NOTICE OF ALLOWANCE AND FEE(S) DUE

139305 7590 04/15/2019
 Fowler White Burnett, P.A.
 1395 Brickell Avenue, 14th Floor
 Miami, FL 33131

EXAMINER

PATYK, JANICE JULIA

ART UNIT	PAPER NUMBER
----------	--------------

2912

DATE MAILED: 04/15/2019

APPLICATION NO.	FILING DATE	FIRST NAMED INVENTOR	ATTORNEY DOCKET NO.	CONFIRMATION NO.
29/625,265	11/08/2017	Rui Medeiros Santos	VVL001USP	5612

TITLE OF INVENTION: UTENSIL REST

APPLN. TYPE	ENTITY STATUS	ISSUE FEE DUE	PUBLICATION FEE DUE	PREV. PAID ISSUE FEE	TOTAL FEE(S) DUE	DATE DUE
nonprovisional	UNDISCOUNTED	\$700	\$0.00	\$0.00	\$700	07/15/2019

THE APPLICATION IDENTIFIED ABOVE HAS BEEN EXAMINED AND IS ALLOWED FOR ISSUANCE AS A PATENT. PROSECUTION ON THE MERITS IS CLOSED. THIS NOTICE OF ALLOWANCE IS NOT A GRANT OF PATENT RIGHTS. THIS APPLICATION IS SUBJECT TO WITHDRAWAL FROM ISSUE AT THE INITIATIVE OF THE OFFICE OR UPON PETITION BY THE APPLICANT. SEE 37 CFR 1.313 AND MPEP 1308.

THE ISSUE FEE AND PUBLICATION FEE (IF REQUIRED) MUST BE PAID WITHIN THREE MONTHS FROM THE MAILING DATE OF THIS NOTICE OR THIS APPLICATION SHALL BE REGARDED AS ABANDONED. THIS STATUTORY PERIOD CANNOT BE EXTENDED. SEE 35 U.S.C. 151. THE ISSUE FEE DUE INDICATED ABOVE DOES NOT REFLECT A CREDIT FOR ANY PREVIOUSLY PAID ISSUE FEE IN THIS APPLICATION. IF AN ISSUE FEE HAS PREVIOUSLY BEEN PAID IN THIS APPLICATION (AS SHOWN ABOVE), THE RETURN OF PART B OF THIS FORM WILL BE CONSIDERED A REQUEST TO REAPPLY THE PREVIOUSLY PAID ISSUE FEE TOWARD THE ISSUE FEE NOW DUE.

HOW TO REPLY TO THIS NOTICE:

I. Review the ENTITY STATUS shown above. If the ENTITY STATUS is shown as SMALL or MICRO, verify whether entitlement to that entity status still applies.

If the ENTITY STATUS is the same as shown above, pay the TOTAL FEE(S) DUE shown above.

If the ENTITY STATUS is changed from that shown above, on PART B - FEE(S) TRANSMITTAL, complete section number 5 titled "Change in Entity Status (from status indicated above)".

For purposes of this notice, small entity fees are 1/2 the amount of undiscounted fees, and micro entity fees are 1/2 the amount of small entity fees.

II. PART B - FEE(S) TRANSMITTAL, or its equivalent, must be completed and returned to the United States Patent and Trademark Office (USPTO) with your ISSUE FEE and PUBLICATION FEE (if required). If you are charging the fee(s) to your deposit account, section "4b" of Part B - Fee(s) Transmittal should be completed and an extra copy of the form should be submitted. If an equivalent of Part B is filed, a request to reapply a previously paid issue fee must be clearly made, and delays in processing may occur due to the difficulty in recognizing the paper as an equivalent of Part B.

III. All communications regarding this application must give the application number. Please direct all communications prior to issuance to Mail Stop ISSUE FEE unless advised to the contrary.

IMPORTANT REMINDER: Maintenance fees are due in utility patents issuing on applications filed on or after Dec. 12, 1980. It is patentee's responsibility to ensure timely payment of maintenance fees when due. More information is available at www.uspto.gov/PatentMaintenanceFees.

PART B - FEE(S) TRANSMITTAL

Complete and send this form, together with applicable fee(s), by mail or fax, or via EFS-Web.

By mail, send to: Mail Stop ISSUE FEE
 Commissioner for Patents
 P.O. Box 1450
 Alexandria, Virginia 22313-1450

By fax, send to: (571)-273-2885

INSTRUCTIONS: This form should be used for transmitting the ISSUE FEE and PUBLICATION FEE (if required). Blocks 1 through 5 should be completed where appropriate. All further correspondence including the Patent, advance orders and notification of maintenance fees will be mailed to the current correspondence address as indicated unless corrected below or directed otherwise in Block 1, by (a) specifying a new correspondence address; and/or (b) indicating a separate "FEE ADDRESS" for maintenance fee notifications.

CURRENT CORRESPONDENCE ADDRESS (Note: Use Block 1 for any change of address)

139305 7590 04/15/2019
 Fowler White Burnett, P.A.
 1395 Brickell Avenue, 14th Floor
 Miami, FL 33131

Note: A certificate of mailing can only be used for domestic mailings of the Fee(s) Transmittal. This certificate cannot be used for any other accompanying papers. Each additional paper, such as an assignment or formal drawing, must have its own certificate of mailing or transmission.

Certificate of Mailing or Transmission

I hereby certify that this Fee(s) Transmittal is being deposited with the United States Postal Service with sufficient postage for first class mail in an envelope addressed to the Mail Stop ISSUE FEE address above, or being transmitted to the USPTO via EFS-Web or by facsimile to (571) 273-2885, on the date below.

_____	(Typed or printed name)
_____	(Signature)
_____	(Date)

APPLICATION NO.	FILING DATE	FIRST NAMED INVENTOR	ATTORNEY DOCKET NO.	CONFIRMATION NO.
29/625,265	11/08/2017	Rui Medeiros Santos	VVI.001USP	5612

TITLE OF INVENTION: UTENSIL REST

APPLN. TYPE	ENTITY STATUS	ISSUE FEE DUE	PUBLICATION FEE DUE	PREV. PAID ISSUE FEE	TOTAL FEE(S) DUE	DATE DUE
nonprovisional	UNDISCOUNTED	\$700	\$0.00	\$0.00	\$700	07/15/2019

EXAMINER	ART UNIT	CLASS-SUBCLASS
PATYK, JANICE JULIA	2912	D07-637000

1. Change of correspondence address or indication of "Fee Address" (37 CFR 1.363).

- Change of correspondence address (or Change of Correspondence Address form PTO/SB/122) attached.
- "Fee Address" indication (or "Fee Address" Indication form PTO/SB/47; Rev 03-09 or more recent) attached. **Use of a Customer Number is required.**

2. For printing on the patent front page, list

- (1) The names of up to 3 registered patent attorneys or agents OR, alternatively, 1 _____
- (2) The name of a single firm (having as a member a registered attorney or agent) and the names of up to 2 registered patent attorneys or agents. If no name is listed, no name will be printed. 2 _____
- 3 _____

3. ASSIGNEE NAME AND RESIDENCE DATA TO BE PRINTED ON THE PATENT (print or type)

PLEASE NOTE: Unless an assignee is identified below, no assignee data will appear on the patent. If an assignee is identified below, the document must have been previously recorded, or filed for recordation, as set forth in 37 CFR 3.11 and 37 CFR 3.81(a). Completion of this form is NOT a substitute for filing an assignment.

(A) NAME OF ASSIGNEE _____ (B) RESIDENCE: (CITY and STATE OR COUNTRY) _____

Please check the appropriate assignee category or categories (will not be printed on the patent): Individual Corporation or other private group entity Government

4a. Fees submitted: Issue Fee Publication Fee (if required) Advance Order - # of Copies _____

4b. Method of Payment: (Please first reapply any previously paid fee shown above)

- Electronic Payment via EFS-Web Enclosed check Non-electronic payment by credit card (Attach form PTO-2038)
- The Director is hereby authorized to charge the required fee(s), any deficiency, or credit any overpayment to Deposit Account No. _____

5. Change in Entity Status (from status indicated above)

- Applicant certifying micro entity status. See 37 CFR 1.29
- Applicant asserting small entity status. See 37 CFR 1.27
- Applicant changing to regular undiscounted fee status.

NOTE: Absent a valid certification of Micro Entity Status (see forms PTO/SB/15A and 15B), issue fee payment in the micro entity amount will not be accepted at the risk of application abandonment.
 NOTE: If the application was previously under micro entity status, checking this box will be taken to be a notification of loss of entitlement to micro entity status.
 NOTE: Checking this box will be taken to be a notification of loss of entitlement to small or micro entity status, as applicable.

NOTE: This form must be signed in accordance with 37 CFR 1.31 and 1.33. See 37 CFR 1.4 for signature requirements and certifications.

Authorized Signature _____ Date _____
 Typed or printed name _____ Registration No. _____

UNITED STATES PATENT AND TRADEMARK OFFICE

UNITED STATES DEPARTMENT OF COMMERCE
United States Patent and Trademark Office
 Address: COMMISSIONER FOR PATENTS
 P.O. Box 1450
 Alexandria, Virginia 22313-1450
 www.uspto.gov

APPLICATION NO.	FILING DATE	FIRST NAMED INVENTOR	ATTORNEY DOCKET NO.	CONFIRMATION NO.
29/625,265	11/08/2017	Rui Medeiros Santos	VV1.001USP	5612
139305	7590	04/15/2019	EXAMINER	
Fowler White Burnett, P.A. 1395 Brickell Avenue, 14th Floor Miami, FL 33131			PATYK, JANICE JULIA	
			ART UNIT	PAPER NUMBER
			2912	
DATE MAILED: 04/15/2019				

Determination of Patent Term Adjustment under 35 U.S.C. 154 (b)
 (Applications filed on or after May 29, 2000)

The Office has discontinued providing a Patent Term Adjustment (PTA) calculation with the Notice of Allowance.

Section 1(h)(2) of the AIA Technical Corrections Act amended 35 U.S.C. 154(b)(3)(B)(i) to eliminate the requirement that the Office provide a patent term adjustment determination with the notice of allowance. See Revisions to Patent Term Adjustment, 78 Fed. Reg. 19416, 19417 (Apr. 1, 2013). Therefore, the Office is no longer providing an initial patent term adjustment determination with the notice of allowance. The Office will continue to provide a patent term adjustment determination with the Issue Notification Letter that is mailed to applicant approximately three weeks prior to the issue date of the patent, and will include the patent term adjustment on the patent. Any request for reconsideration of the patent term adjustment determination (or reinstatement of patent term adjustment) should follow the process outlined in 37 CFR 1.705.

Any questions regarding the Patent Term Extension or Adjustment determination should be directed to the Office of Patent Legal Administration at (571)-272-7702. Questions relating to issue and publication fee payments should be directed to the Customer Service Center of the Office of Patent Publication at 1-(888)-786-0101 or (571)-272-4200.

OMB Clearance and PRA Burden Statement for PTOL-85 Part B

The Paperwork Reduction Act (PRA) of 1995 requires Federal agencies to obtain Office of Management and Budget approval before requesting most types of information from the public. When OMB approves an agency request to collect information from the public, OMB (i) provides a valid OMB Control Number and expiration date for the agency to display on the instrument that will be used to collect the information and (ii) requires the agency to inform the public about the OMB Control Number's legal significance in accordance with 5 CFR 1320.5(b).

The information collected by PTOL-85 Part B is required by 37 CFR 1.311. The information is required to obtain or retain a benefit by the public which is to file (and by the USPTO to process) an application. Confidentiality is governed by 35 U.S.C. 122 and 37 CFR 1.14. This collection is estimated to take 30 minutes to complete, including gathering, preparing, and submitting the completed application form to the USPTO. Time will vary depending upon the individual case. Any comments on the amount of time you require to complete this form and/or suggestions for reducing this burden, should be sent to the Chief Information Officer, U.S. Patent and Trademark Office, U.S. Department of Commerce, P.O. Box 1450, Alexandria, Virginia 22313-1450. DO NOT SEND FEES OR COMPLETED FORMS TO THIS ADDRESS. SEND TO: Commissioner for Patents, P.O. Box 1450, Alexandria, Virginia 22313-1450. Under the Paperwork Reduction Act of 1995, no persons are required to respond to a collection of information unless it displays a valid OMB control number.

Privacy Act Statement

The Privacy Act of 1974 (P.L. 93-579) requires that you be given certain information in connection with your submission of the attached form related to a patent application or patent. Accordingly, pursuant to the requirements of the Act, please be advised that: (1) the general authority for the collection of this information is 35 U.S.C. 2(b); (2) furnishing of the information solicited is voluntary; and (3) the principal purpose for which the information is used by the U.S. Patent and Trademark Office is to process and/or examine your submission related to a patent application or patent. If you do not furnish the requested information, the U.S. Patent and Trademark Office may not be able to process and/or examine your submission, which may result in termination of proceedings or abandonment of the application or expiration of the patent.

The information provided by you in this form will be subject to the following routine uses:

1. The information on this form will be treated confidentially to the extent allowed under the Freedom of Information Act (5 U.S.C. 552) and the Privacy Act (5 U.S.C. 552a). Records from this system of records may be disclosed to the Department of Justice to determine whether disclosure of these records is required by the Freedom of Information Act.
2. A record from this system of records may be disclosed, as a routine use, in the course of presenting evidence to a court, magistrate, or administrative tribunal, including disclosures to opposing counsel in the course of settlement negotiations.
3. A record in this system of records may be disclosed, as a routine use, to a Member of Congress submitting a request involving an individual, to whom the record pertains, when the individual has requested assistance from the Member with respect to the subject matter of the record.
4. A record in this system of records may be disclosed, as a routine use, to a contractor of the Agency having need for the information in order to perform a contract. Recipients of information shall be required to comply with the requirements of the Privacy Act of 1974, as amended, pursuant to 5 U.S.C. 552a(m).
5. A record related to an International Application filed under the Patent Cooperation Treaty in this system of records may be disclosed, as a routine use, to the International Bureau of the World Intellectual Property Organization, pursuant to the Patent Cooperation Treaty.
6. A record in this system of records may be disclosed, as a routine use, to another federal agency for purposes of National Security review (35 U.S.C. 181) and for review pursuant to the Atomic Energy Act (42 U.S.C. 218(c)).
7. A record from this system of records may be disclosed, as a routine use, to the Administrator, General Services, or his/her designee, during an inspection of records conducted by GSA as part of that agency's responsibility to recommend improvements in records management practices and programs, under authority of 44 U.S.C. 2904 and 2906. Such disclosure shall be made in accordance with the GSA regulations governing inspection of records for this purpose, and any other relevant (i.e., GSA or Commerce) directive. Such disclosure shall not be used to make determinations about individuals.
8. A record from this system of records may be disclosed, as a routine use, to the public after either publication of the application pursuant to 35 U.S.C. 122(b) or issuance of a patent pursuant to 35 U.S.C. 151. Further, a record may be disclosed, subject to the limitations of 37 CFR 1.14, as a routine use, to the public if the record was filed in an application which became abandoned or in which the proceedings were terminated and which application is referenced by either a published application, an application open to public inspection or an issued patent.
9. A record from this system of records may be disclosed, as a routine use, to a Federal, State, or local law enforcement agency, if the USPTO becomes aware of a violation or potential violation of law or regulation.

Notice of Allowability For A Design Application	Application No. 29/625,265	Applicant(s) Santos et al.	
	Examiner JANICE J PATYK	Art Unit 2912	AIA (FITF) Status Yes

-- The MAILING DATE of this communication appears on the cover sheet with the correspondence address--

All claims being allowable, PROSECUTION ON THE MERITS IS (OR REMAINS) CLOSED in this application. If not included herewith (or previously mailed), a Notice of Allowance (PTOL-85) or other appropriate communication will be mailed in due course. **THIS NOTICE OF ALLOWABILITY IS NOT A GRANT OF PATENT RIGHTS.** This application is subject to withdrawal from issue at the initiative of the Office or upon petition by the applicant. See 37 CFR 1.313 and MPEP 1308. This notice does not set or reset the time period for paying the issue fee. The issue fee must be paid within THREE MONTHS FROM THE MAILING DATE of the Notice of Allowance (PTOL-85) or this application shall be regarded as ABANDONED. This statutory period cannot be extended. See 35 U.S.C.151.

1. This communication is responsive to amendment - February 19, 2019 .
 A declaration(s)/affidavit(s) under 37 CFR 1.130(b) was/were filed on _____ .
2. An election was made by the applicant in response to a restriction requirement set forth during the interview on _____ the restriction requirement and election have been incorporated into this action.
3. The claim is allowed.
4. Acceptable drawings:
(a) The drawings filed on 19 February 2019 are accepted by the Examiner.
(b) Drawing Figures filed on _____ and drawing Figures filed on _____ are accepted by the _____ Examiner.
5. The claim for foreign priority under 35 U.S.C. § 119(a)-(d) or (f) is acknowledged.

Certified copies:

- a) All b) Some *c) None of the:
- Certified copies of the priority documents have been received.
 - Certified copies of the priority documents have been received in Application No. _____.
 - Copies of the certified copies of the priority documents have been received in this national stage application from the International Bureau (PCT Rule 17.2(a)).
- * Certified copies not received: _____

Applicant has THREE MONTHS FROM THE "MAILING DATE" of this communication to file a reply complying with the requirement for corrected drawings noted in item 6 below. Failure to timely comply will result in ABANDONMENT of this application. **THIS THREE-MONTH PERIOD IS NOT EXTENDABLE.** See 37 CFR 1.85(c). **NOTE: This notice does not set or reset the time period for paying the issue fee.**

6. CORRECTED DRAWINGS (as "replacement sheets") must be submitted.
 including changes required by the attached Examiner's Amendment / Comment or in the Office action of Paper No./Mail Date _____ .
- Identifying indicia such as the application number (see 37 CFR 1.84(c)) should be written on the drawings in the front (not the back) of each sheet. Replacement sheet(s) should be labeled as such in the header according to 37 CFR 1.121(d).

Attachment(s)

- | | |
|--|---|
| 1. <input type="checkbox"/> Notice of References Cited (PTO-892) | 4. <input type="checkbox"/> Examiner's Amendment/Comment |
| 2. <input type="checkbox"/> Information Disclosure Statements (PTO/SB/08),
Paper No./Receipt Date _____ | 5. <input type="checkbox"/> Examiner's Statement of Reasons for Allowance |
| 3. <input type="checkbox"/> Interview Summary (PTO-413),
Paper No./Mail Date _____ | 6. <input type="checkbox"/> Other _____ |

NOTE: PRINT FROM SCORE

/JANICE PATYK/
Examiner, Art Unit 2912

/DERRICK E HOLLAND/
Primary Examiner, Art Unit 2912

Search Notes 	Application/Control No. 29/625,265	Applicant(s)/Patent Under Reexamination Santos et al.
	Examiner JANICE J PATYK	Art Unit 2912

CPC - Searched*		
Symbol	Date	Examiner
A47G21/06,14	03/20/2019	JP
A47G29/08		
B65D43/169		
B65D45/00		
B67B7/16,44		

CPC Combination Sets - Searched*		
Symbol	Date	Examiner

US Classification - Searched*			
Class	Subclass	Date	Examiner
D3	273,274	03/20/2019	JP
D7	631,637-641,550.1		
D9	420-426,432		
D19	77,81-86		
206	553,557,562,564		
211	60.1,70.1,70.7		
220	23.83		

* See search history printout included with this form or the SEARCH NOTES box below to determine the scope of the search.

/JANICE JULIA PATYK/ Examiner, Art Unit 2912	
---	--

<i>Search Notes</i> 	Application/Control No. 29/625,265	Applicant(s)/Patent Under Reexamination Santos et al.
	Examiner JANICE J PATYK	Art Unit 2912

Search Notes		
Search Notes	Date	Examiner
Google image search on utensil rest	11/05/2018	JP
Performed inventor, assignee search on EAST		
EAST Keyword search(see attached)		
EAST forward/backward search		
Updated search	03/20/2019	JP

Interference Search			
US Class/CPC Symbol	US Subclass/CPC Group	Date	Examiner
D7	637	03/20/2019	JP

/JANICE JULIA PATYK/ Examiner, Art Unit 2912	
---	--

Issue Classification 	Application/Control No. 29/625,265	Applicant(s)/Patent Under Reexamination Santos et al.
	Examiner JANICE J PATYK	Art Unit 2912

CPC		
Symbol	Type	Version

CPC Combination Sets				
Symbol	Type	Set	Ranking	Version

Use images from artifact folder? <input type="radio"/> Yes <input checked="" type="radio"/> No			
/JANICE PATYK/ Examiner, Art Unit 2912 (Assistant Examiner)	20 March 2019 (Date)	Total Claims Allowed: 1	
/DERRICK E HOLLAND/ Primary Examiner, Art Unit 2912 (Primary Examiner)	28 March 2019 (Date)	O.G. Print Claim(s) 1	O.G. Print Figure 1

Issue Classification 	Application/Control No. 29/625,265	Applicant(s)/Patent Under Reexamination Santos et al.
	Examiner JANICE J PATYK	Art Unit 2912

INTERNATIONAL CLASSIFICATION			
CLAIMED			
	/	07	/

NON-CLAIMED			
	/		/

US ORIGINAL CLASSIFICATION	
CLASS	SUBCLASS
D7	637

CROSS REFERENCES(S)					
CLASS	SUBCLASS (ONE SUBCLASS PER BLOCK)				

Use images from artifact folder? <input checked="" type="radio"/> Yes <input type="radio"/> No			
/JANICE PATYK/ Examiner, Art Unit 2912 (Assistant Examiner)	20 March 2019 (Date)	Total Claims Allowed: 1	
/DERRICK E HOLLAND/ Primary Examiner, Art Unit 2912 (Primary Examiner)	28 March 2019 (Date)	O.G. Print Claim(s) 1	O.G. Print Figure 1

Issue Classification 	Application/Control No. 29/625,265	Applicant(s)/Patent Under Reexamination Santos et al.
	Examiner JANICE J PATYK	Art Unit 2912

Claims renumbered in the same order as presented by applicant
 CPA
 T.D.
 R.1.47

CLAIMS															
Final	Original	Final	Original	Final	Original	Final	Original	Final	Original	Final	Original	Final	Original	Final	Original
	1														

Use images from artifact folder? <input checked="" type="radio"/> Yes <input type="radio"/> No			
/JANICE PATYK/ Examiner, Art Unit 2912 (Assistant Examiner)	20 March 2019 (Date)	Total Claims Allowed: 1	
/DERRICK E HOLLAND/ Primary Examiner, Art Unit 2912 (Primary Examiner)	28 March 2019 (Date)	O.G. Print Claim(s) 1	O.G. Print Figure 1

Bibliographic Data

Application No: 29/625,265

Foreign Priority claimed: Yes No35 USC 119 (a-d) conditions met: Yes No Met After Allowance

Verified and Acknowledged:

/JANICE PATYK/

Examiner's Signature

Initials

Title:

UTENSIL REST

FILING or 371(c) DATE	CLASS	GROUP ART UNIT	ATTORNEY DOCKET NO.
11/08/2017	D07	2912	
RULE			

APPLICANTS

Vacu Vin Innovations Ltd., Delfgauw, NETHERLANDS

INVENTORS

Rui Medeiros Santos Rotterdam, NETHERLANDS

Sandra van Oosterbaan-Rijnen Barendrecht, NETHERLANDS

Delphine Buyse Voorburg, NETHERLANDS

CONTINUING DATA**FOREIGN APPLICATIONS****IF REQUIRED, FOREIGN LICENSE GRANTED****

11/09/2017

STATE OR COUNTRY

NETHERLANDS

ADDRESS**FILING FEE RECEIVED**

\$760

Application No.: 29/625,265
Reply to Office Action of November 19, 2018
Replacement Sheet 1 of 7

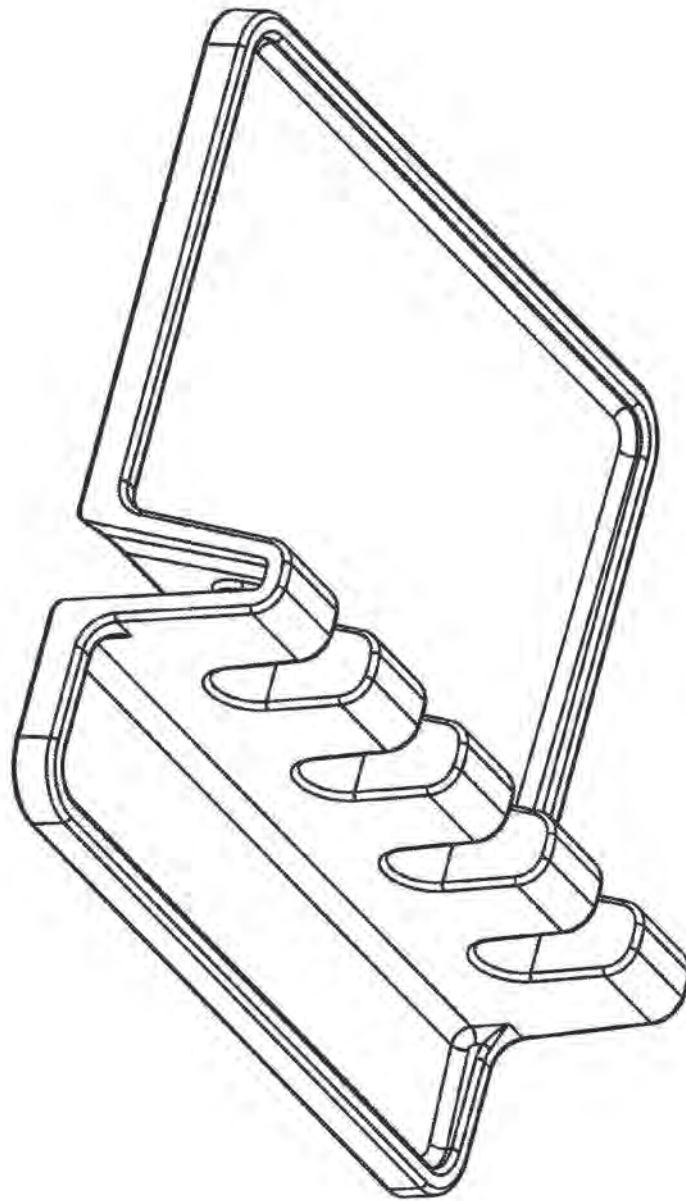

FIGURE 1

Reply to Office Action of November 19, 2018

Replacement Sheet 2 of 7

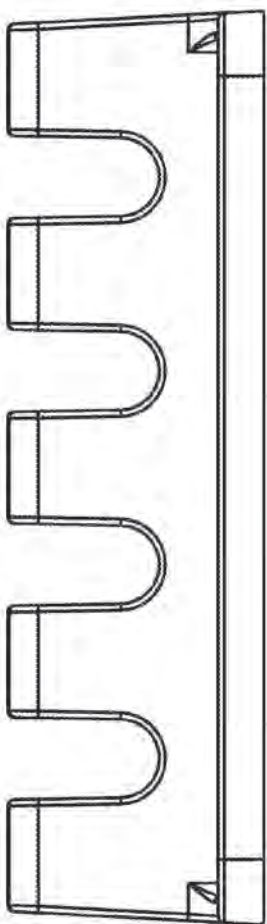

FIGURE 2

Application No.: 29/625,265
Reply to Office Action of November 19, 2018
Replacement Sheet 3 of 7

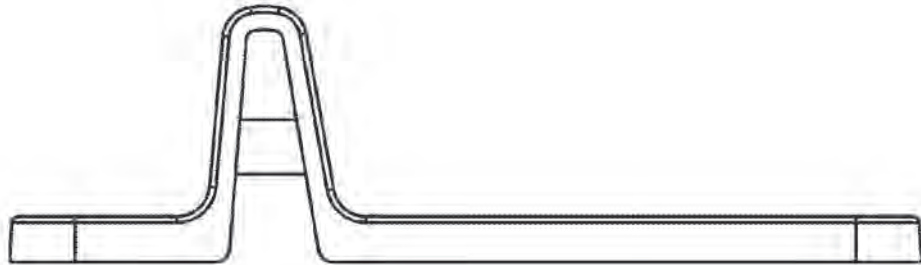

FIGURE 3

Application No.: 29/625,265
Reply to Office Action of November 19, 2018
Replacement Sheet 4 of 7

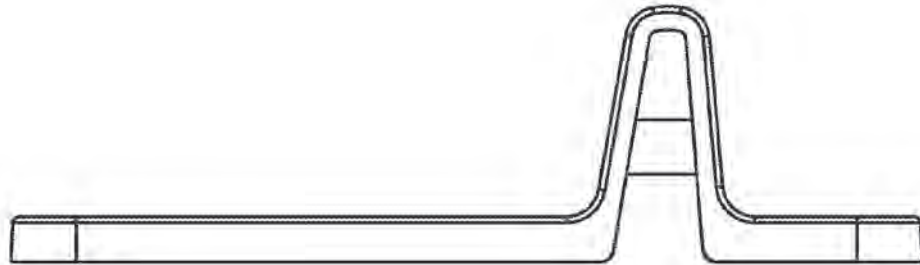

FIGURE 4

Application No.: 29/625,265
Reply to Office Action of November 19, 2018
Replacement Sheet 5 of 7

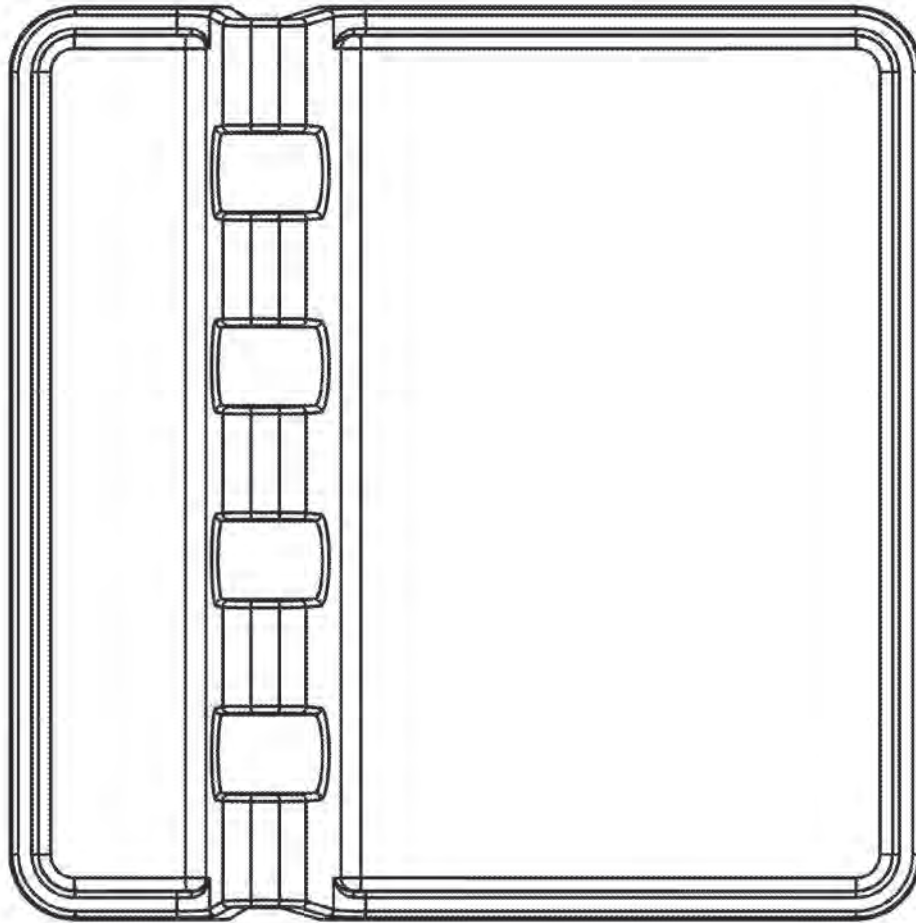

FIGURE 5

Applicaition No. 29/265,265
Reply to Office Action of November 19, 2018
Replacement Sheet 6 or 7

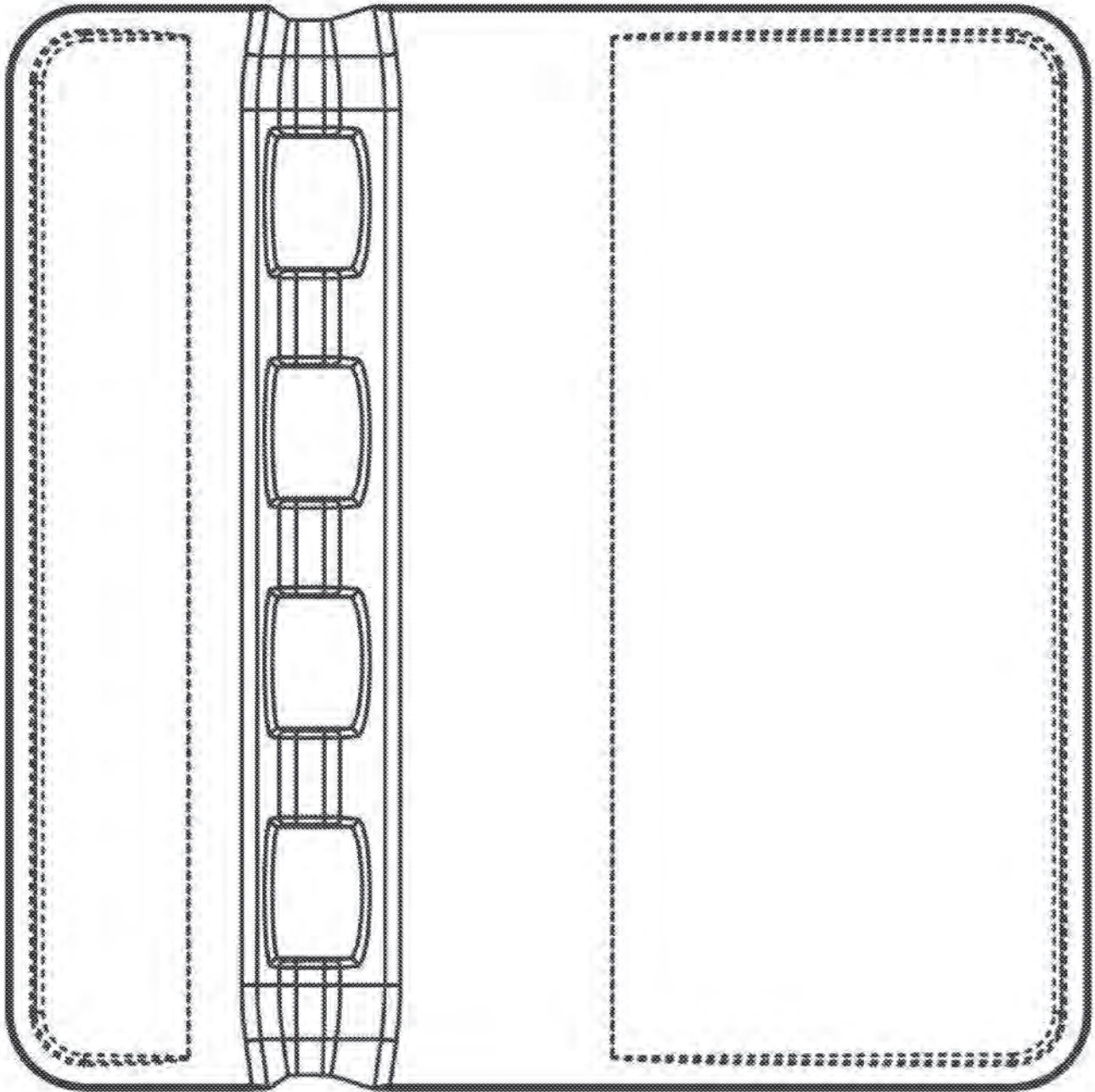

FIGURE 6

Application No.: 29/625,265
Reply to Office Action of November 19, 2018
Replacement Sheet 7 of 7

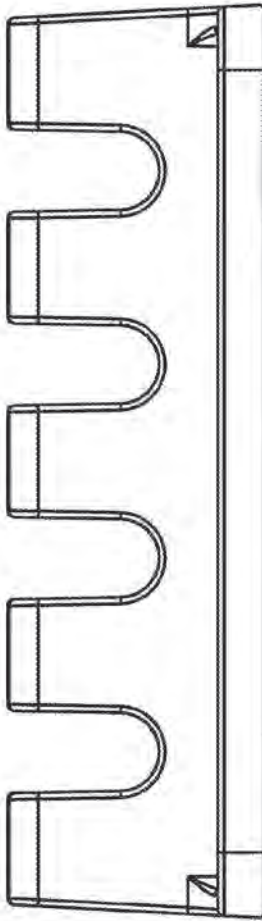

FIGURE 7

Electronic Acknowledgement Receipt

EFS ID:	35192602
Application Number:	29625265
International Application Number:	
Confirmation Number:	5612
Title of Invention:	UTENSIL REST
First Named Inventor/Applicant Name:	Rui Medeiros Santos
Customer Number:	139305
Filer:	Alberto Álvarez
Filer Authorized By:	
Attorney Docket Number:	WI.001USP
Receipt Date:	19-FEB-2019
Filing Date:	08-NOV-2017
Time Stamp:	17:09:37
Application Type:	Design

Payment information:

Submitted with Payment	no
------------------------	----

File Listing:

Document Number	Document Description	File Name	File Size(Bytes)/ Message Digest	Multi Part /.zip	Pages (if appl.)
1		ResponsetoOfficeActionwithdrawingsFINAL2.pdf	4556405 517bdc7a128acd7675e62b52654c52002: 0a9444	yes	13

Multipart Description/PDF files in .zip description		
Document Description	Start	End
Amendment/Req. Reconsideration-After Non-Final Reject	1	6
Drawings-only black and white line drawings	7	13
Warnings:		
Information:		
Total Files Size (in bytes):		4556405
<p>This Acknowledgement Receipt evidences receipt on the noted date by the USPTO of the indicated documents, characterized by the applicant, and including page counts, where applicable. It serves as evidence of receipt similar to a Post Card, as described in MPEP 503.</p> <p><u>New Applications Under 35 U.S.C. 111</u> If a new application is being filed and the application includes the necessary components for a filing date (see 37 CFR 1.53(b)-(d) and MPEP 506), a Filing Receipt (37 CFR 1.54) will be issued in due course and the date shown on this Acknowledgement Receipt will establish the filing date of the application.</p> <p><u>National Stage of an International Application under 35 U.S.C. 371</u> If a timely submission to enter the national stage of an international application is compliant with the conditions of 35 U.S.C. 371 and other applicable requirements a Form PCT/DO/EO/903 indicating acceptance of the application as a national stage submission under 35 U.S.C. 371 will be issued in addition to the Filing Receipt, in due course.</p> <p><u>New International Application Filed with the USPTO as a Receiving Office</u> If a new international application is being filed and the international application includes the necessary components for an international filing date (see PCT Article 11 and MPEP 1810), a Notification of the International Application Number and of the International Filing Date (Form PCT/RO/105) will be issued in due course, subject to prescriptions concerning national security, and the date shown on this Acknowledgement Receipt will establish the international filing date of the application.</p>		

IN THE UNITED STATES PATENT AND TRADEMARK OFFICE

Application Number: 29/625,265
Confirmation No.: 5612
Filing Date: November 8, 2017
Applicant: Vacu Vin Innovations Ltd.
Entitled: UTENSIL REST
Examiner: Janice Julia Patyk
Group Art Unit: 2912
Attorney Docket No.: VVL001USP

RESPONSE TO OFFICE ACTION

Mailbox: Amendment
Commissioner for Patents
P.O. Box 1450
Alexandria, Virginia 22313-1450

Dear Commissioner:

In response to the non-final Office Action dated November 19, 2018 in the above-captioned application, please enter and consider the following amendments and remarks. Applicant submits these amendments and remarks to clarify the present invention, are made without prejudice or disclaimer and are independent of patentability.

Amendments to the Description begin on page 2 of this document.

Amendments to the Drawings begin on page 3 of this document and include attached replacement sheets, which replace the original 7 sheets that include Figures 1, 2, 3, 4, 5, 6 and 7.

Remarks begin on page 4 of this document.

An **Appendix** including amended drawing figures is attached following page 5 of this paper.

Amendments to the Description:

Please amend the Description as set forth below. In the following amended Description, additional text is indicated by underlining (“XXXXXX”) and deleted text is indicated by a strikethrough (“~~XXXX~~”):

DESCRIPTION OF THE FIGURES OF THE DRAWINGS

FIG. 1 is a top perspective view of a utensil rest, showing our new design;

FIG. 2 is a front ~~plan~~ view thereof;

FIG. 3 is a right side ~~plan~~ view thereof;

FIG. 4 is a left side ~~plan~~ view thereof;

FIG. 5 is a top view thereof;

FIG. 6 is a bottom view thereof; and

FIG. 7 is a back ~~plan~~ view thereof.

The broken lines in the figures illustrate the portions of the design that form no part of the claimed design.

Amendments to the Drawings:

The sheets of drawings attached hereto as an Appendix include changes to the first sheet, which replaces the original sheet that included Figure 1, changes to the second sheet, which replaces the original sheet that included Figure 2, changes to the third sheet, which replaces the original sheet that included Figure 3, changes to the fourth sheet, which replaces the original sheet that included Figure 4, changes to the fifth sheet, which replaces the original sheet that included Figure 5, changes to the sixth sheet, which replaces the original sheet that included Figure 6, and changes to the seventh sheet, which replaces the original sheet that included Figure 7.

Each of the seven replacement sheets include amendments to its corresponding original sheet that include figures with better line quality and higher resolution to better define the claimed design. The replacement sheet corresponding to the original sheet that included Figure 6 identifies elements that are not part of the design sought to be patented. The elements that are not part of the design to be patented are identified by a broken line illustration.

Appendix: Replacement Sheets

REMARKS

This is a full and timely response to the outstanding Office Action dated November 19, 2018.

The changes herein reflect and include the matters addressed in the office action.

1. **Objection to the Drawing.**

As stated in the pending Office Action, the Examiner objected to the drawings because the line quality throughout the figures is poor and unclear and the solid lines appeared pixelated and merged to form heavy line weight in certain places, making the views unclear. The Examiner stated that for clarity in the disclosure, it is required that Applicant improve the line quality and better define the heavy line weight merged areas. The Examiner requested a full set of corrected drawings/replacement sheets in this reply to avoid abandonment of the application.

2. **Rejection under 35 USC §112(a) and (b).**

As stated in the pending Office Action, the Examiner rejected the claim because claimed invention was not described in such full, clear, concise and exact terms as to enable a person of reasonable skill in the art to make and use the same, and failed to particularly point out and distinctly claim the subject matter which Applicant regards as the invention. Furthermore, the claim was rejected as indefinite and non-enabling because the shape and appearance of the claimed design cannot be understood.

Specifically, the Examiner noted that the drawing in Figure 6 reflects the bottom surface shown with two rectangular surfaces where no other view shows such enclosed surfaces, making the exact depth and surface delineations of the bottom surfaces unclear.

3. Changes to the Drawings.

Per the Examiner's comments and suggestions as set forth in the pending Office Action, Applicant has amended the pending application to amend the original Figures 1, 2, 3, 4, 5, 6 and 7. Figure 1, 2, 3, 4, 5, 6, and 7 have been amended to show improved line quality and high resolution drawings that better define the heavy line weight merged areas. Figure 6 has further been amended to show, through a broken line illustration, that certain elements in the drawing are not part of the design sought to be patented. The amendments to the drawings do not add any new material to the application. They merely improve the quality of the drawings and clarify that certain elements illustrated in the drawings are not part of the design sought to be patented. Accordingly, it is respectfully submitted that the rejection has been overcome through the above referenced amendments and respectfully that the rejection be withdrawn.

The present application is in condition for allowance of the claim, and Applicant respectfully requests favorable action. In order to facilitate the resolution of any questions, the Examiner is invited to contact the undersigned attorney.

Respectfully submitted,

s/Alberto Alvarez
Alberto Alvarez
Reg. No. 69260
Peretz Chesal & Herrmann, P.L.
2 S. Biscayne Blvd., Suite 3700
Miami, Florida 33131
Telephone: (305) 341-3000
aalvarez@pch-iplaw.com

Application No.: 29/625,265
Group Art Unit: 2912
Filing Date: November 8, 2017
Examiner Janice Julia Patyk
Attorney Docket No.: VVI.001USP

APPENDIX

DocCode – SCORE

SCORE Placeholder Sheet for IFW Content

Application Number: 29625265

Document Date: 02/19/2019

The presence of this form in the IFW record indicates that the following document type was received in electronic format on the date identified above. This content is stored in the SCORE database.

Since this was an electronic submission, there is no physical artifact folder, no artifact folder is recorded in PALM, and no paper documents or physical media exist. The TIFF images in the IFW record were created from the original documents that are stored in SCORE.

- Drawing

At the time of document entry (noted above):

- USPTO employees may access SCORE content via eDAN using the Supplemental Content tab, or via the SCORE web page.
- External customers may access SCORE content via PAIR using the Supplemental Content tab.



UNITED STATES PATENT AND TRADEMARK OFFICE

UNITED STATES DEPARTMENT OF COMMERCE
United States Patent and Trademark Office
 Address: COMMISSIONER FOR PATENTS
 P.O. Box 1450
 Alexandria, Virginia 22313-1450
 www.uspto.gov

APPLICATION NO.	FILING DATE	FIRST NAMED INVENTOR	ATTORNEY DOCKET NO.	CONFIRMATION NO.
29/625,265	11/08/2017	Rui Medeiros Santos	VVI.001USP	5612
139305	7590	11/19/2018	EXAMINER	
Fowler White Burnett, P.A. 1395 Brickell Avenue, 14th Floor Miami, FL 33131			PATYK, JANICE JULIA	
			ART UNIT	PAPER NUMBER
			2912	
			NOTIFICATION DATE	DELIVERY MODE
			11/19/2018	ELECTRONIC

Please find below and/or attached an Office communication concerning this application or proceeding.

The time period for reply, if any, is set in the attached communication.

Notice of the Office communication was sent electronically on above-indicated "Notification Date" to the following e-mail address(es):

JEnglander@fowler-white.com

OFFICE ACTION

The present application, filed on or after March 16, 2013, is being examined under the first inventor to file provisions of the AIA.

Objection to the Drawing

The line quality throughout the figures is poor and unclear. The solid lines appear pixelated and have merged to form heavy line weight in places, making the views unclear. For clarity in the disclosure, it is required that applicant improve the line quality and better define the heavy line weight merged areas (please refer to 37CFR 1.84(k,l,m) for additional guidance). See below exemplary annotation.

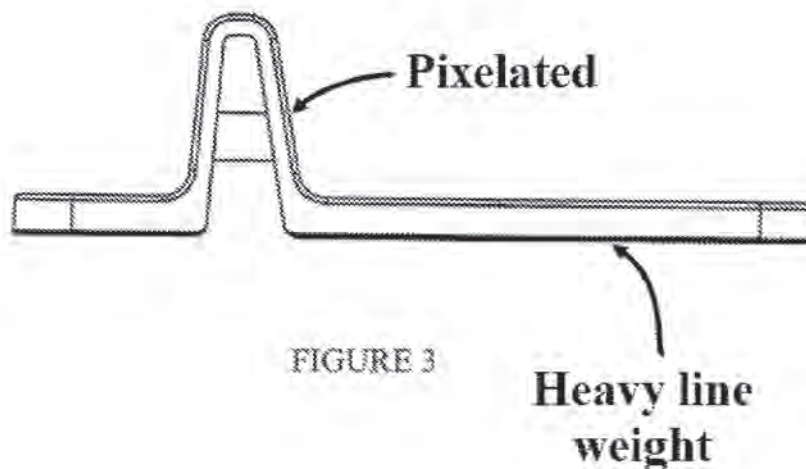

Please submit a full set of corrected drawings / replacement sheets.

Corrected drawing sheets are required in reply to the Office action to avoid abandonment of the application.

Replacement Sheets

Any amended replacement drawing sheet should include all of the figures appearing on the immediate prior version of the sheet, even if only one figure is being amended. The figure or figure number of an amended drawing should not be labeled as "amended."

Application/Control Number: 29/625,265
Art Unit: 2912

Page 3

If a drawing figure is to be canceled, the appropriate figure must be removed from the replacement sheet, and where necessary, the remaining figures must be renumbered and appropriate changes made to the brief description of the several views of the drawings for consistency. Additional replacement sheets may be necessary to show the renumbering of the remaining figures. If all the figures on a drawing sheet are canceled, a replacement sheet is not required. A marked-up copy of the drawing sheet (labeled as "Annotated Sheet") including an annotation showing that all the figures on that drawing sheet have been canceled must be presented in the amendment or remarks section that explains the change to the drawings. Each drawing sheet submitted after the filing date of an application must be labeled in the top margin as either "Replacement Sheet" or "New Sheet" pursuant to 37 CFR 1.121(d).

If the changes are not accepted by the examiner, the applicant will be notified and informed of any required corrective action in the next Office action.

When preparing new drawings in compliance with the requirement therefor, care must be exercised to avoid introduction of anything which could be construed to be new matter prohibited by 35 U.S.C. 132 and 37 CFR 1.121(f). This pertains to either: the addition to, or the removal of, any elements shown in the originally disclosed design.

Objection to the Specification

For clarity and proper view designations, the descriptions of **Figs. 1-4 and 7** should be amended as follows:

- **FIG. 1 is a top front perspective view of a utensil rest, showing our new design;**
- FIG. 2 is a front view thereof;**
- FIG. 3 is a right side view thereof;**
- FIG. 4 is a left side view thereof; --**
- **FIG. 7 is a back view thereof. --**

If applicant elects to use the broken lines as suggested in the rejection below, the following statement must be used to describe the broken lines on the drawing (MPEP § 1503.02, subsection III):

- **The broken lines in the figures illustrate the portions of the design that form no part of the claimed design. --**

If used, the above statement should be inserted in the specification preceding the claim.

Rejection – 35 U.S.C. § 112

The claim is rejected under 35 U.S.C. 112(a) and (b) or pre-AIA 35 U.S.C. 112, first and second paragraphs, as the claimed invention is not described in such full, clear, concise and exact terms as to enable any person skilled in the art to make and use the same, and fails to particularly point out and distinctly claim the subject matter which applicant regards as the invention.

The claim is indefinite and nonenabling because the shape and appearance of the claimed design cannot be understood due to the following:

Fig. 6 shows bottom surface shown with two rectangular surfaces (**A**) where no other view shows such enclosed surfaces, making the exact depth and surface delineations of the bottom surfaces unclear. Therefore, it is suggested to convert all of the full line details of (**A**) to broken lines in order to eliminate claim to the indefinite subject matter. See below annotation for clarification.

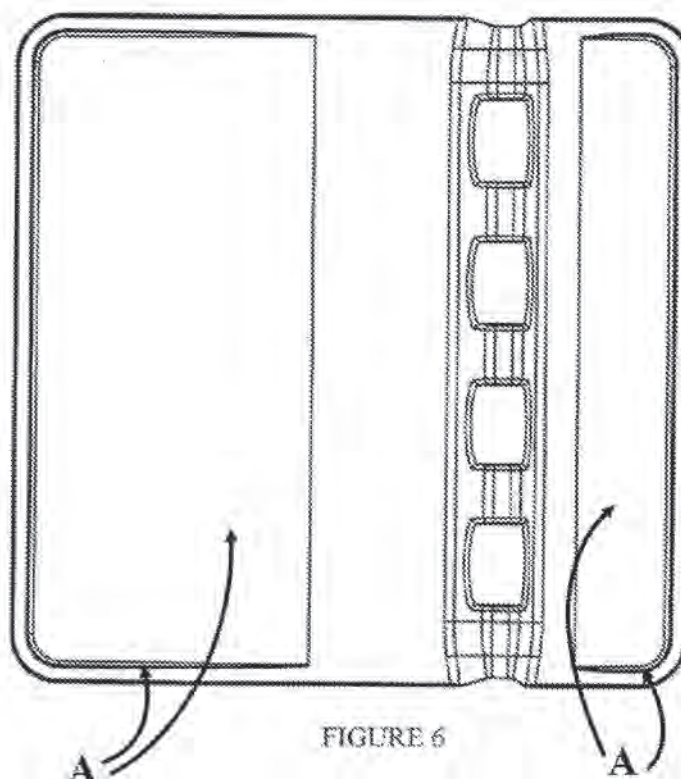

Failure to submit replacement correction sheets overcoming all of the deficiencies in the drawing disclosure set forth above, or an explanation why the drawing corrections or additional drawing views are not necessary will result in the rejection of the claim under 35 U.S.C. 112(a) and (b) or pre-AIA 35 U.S.C. 112, first and second paragraphs, being made FINAL in the next Office action.

Application/Control Number: 29/625,265
Art Unit: 2912

Page 5

The references are cited as pertinent prior art. Applicant may view and obtain copies of the cited references by visiting <<http://www.uspto.gov/patft/index.html>> and pressing the "Patent Number Search" button.

The claim stands rejected under 35 U.S.C. 112 (a) and (b).

Contact

Any inquiry concerning this communication or earlier communications from the examiner should be directed to JANICE J PATYK whose telephone number is (571)272-7594. The examiner can normally be reached on Mon-Thu from 7:00am-5:00pm. If attempts to reach the examiner by telephone are unsuccessful, the examiner's supervisor, Ian Simmons, can be reached on 571-272-2658. The fax phone number for the organization where this application or proceeding is assigned is 571-273-8300. Information regarding the status of an application may be obtained from the Patent Application Information Retrieval (PAIR) system. Status information for published applications may be obtained from either Private PAIR or Public PAIR. Status information for unpublished applications is available through Private PAIR only. For more information about the PAIR system, see <http://portal.uspto.gov/external/portal>. Should you have questions about access to the Private PAIR system, contact the Electronic Business Center (EBC) at 866-217-9197 (toll-free).

/JANICE PATYK/
Examiner, Art Unit 2912

Notice of References Cited	Application/Control No. 29/625,265	Applicant(s)/Patent Under Reexamination Santos et al.	
	Examiner JANICE J PATYK	Art Unit 2912	Page 1 of 1

U.S. PATENT DOCUMENTS

*		Document Number Country Code-Number-Kind Code	Date MM-YYYY	Name	CPC Classification	US Classification
*	A	US-D740619-S	10-2015	Elliott; Terry		D7/637
*	B	US-D689744-S	09-2013	Tarantino; Jay		D19/86
*	C	US-8668171-B2	03-2014	Tarantino; Jay	A47G21/14	220/500
*	D	US-D723875-S	03-2015	Elatrache; Michael		D7/637
*	E	US-7975857-B2	07-2011	Restis; Paula	A47L19/02	206/553
*	F	US-D504587-S	05-2005	Root; Tracy W.		D6/534
*	G	US-20020158031-A1	10-2002	Powers, Norman C.	A47J47/16	211/41.11
*	H	US-6604714-B1	08-2003	Hall; Anson L.	A47F7/0035	206/232
	I					
	J					
	K					
	L					
	M					

FOREIGN PATENT DOCUMENTS

*		Document Number Country Code-Number-Kind Code	Date MM-YYYY	Country	Name	CPC Classification
	N					
	O					
	P					
	Q					
	R					
	S					
	T					

NON-PATENT DOCUMENTS

*		Include as applicable: Author, Title Date, Publisher, Edition or Volume, Pertinent Pages)
	U	
	V	
	W	
	X	

*A copy of this reference is not being furnished with this Office action. (See MPEP § 707.05(a).)

Dates in MM-YYYY format are publication dates. Classifications may be US or foreign.

<i>Search Notes</i> 	Application/Control No. 29/625,265	Applicant(s)/Patent Under Reexamination Santos et al.
	Examiner JANICE J PATYK	Art Unit 2912

CPC - Searched*		
Symbol	Date	Examiner
A47G21/06,14	11/05/2018	JP
A47G29/08		
B65D43/169		
B65D45/00		
B67B7/16,44		

CPC Combination Sets - Searched*		
Symbol	Date	Examiner

US Classification - Searched*			
Class	Subclass	Date	Examiner
D3	273,274	11/05/2018	JP
D7	631,637-641,550.1		
D9	420-426,432		
D19	77,81-86		
206	553,557,562,564		
211	60.1,70.1,70.7		
220	23.83		

* See search history printout included with this form or the SEARCH NOTES box below to determine the scope of the search.

/JANICE JULIA PATYK/ Examiner, Art Unit 2912	
---	--

<i>Search Notes</i> 	Application/Control No. 29/625,265	Applicant(s)/Patent Under Reexamination Santos et al.
	Examiner JANICE J PATYK	Art Unit 2912

Search Notes		
Search Notes	Date	Examiner
Google image search on utensil rest	11/05/2018	JP
Performed inventor, assignee search on EAST		
EAST Keyword search(see attached)		
EAST forward/backward search		

Interference Search			
US Class/CPC Symbol	US Subclass/CPC Group	Date	Examiner
D7	637	11/05/2018	JP

/JANICE JULIA PATYK/ Examiner, Art Unit 2912	
---	--

EAST Search History

EAST Search History (Prior Art)

Ref #	Hits	Search Query	DBs	Default Operator	Plurals	Time Stamp
L7	27	utensil adj3 rest.ti.	US-PGPUB; USPAT; USOCR	OR	OFF	2018/11/06 15:34
L5	0	santos-rui van-oosterbaan-rijnen-sandra buyse-delphine.in.	US-PGPUB; USPAT; USOCR	OR	OFF	2018/11/06 15:33
L4	10	vacu adj vin adj innovations.as.	US-PGPUB; USPAT; USOCR	OR	OFF	2018/11/06 15:32
S70	124	("0178988" "1382652" "3235976" "3416276" "3482980" "3682053" "3718403" "3765784" "3776654" "3918824" "5244303" "5259524" "5419087" "7304852" "D154997" "D190781" "D210208" "D237447" "D237679" "D244340" "D246937" "D250279" "D253144" "D256419" "D257342" "D338583" "D357457" "D367322" "D367715" "D372390" "D387232" "D387398" "D394370" "D403438" "D415847" "D416735" "D426810" "D429531" "D433993" "D475898" "D495296" "D496629" "D497292" "D507447" "D511944" "D524732" "D532259" "D532657" "D539102" "D546478" "D553759" "D556685" "D573417" "D577130" "D582219" "D614778" "D645573" "D664677" "D675345" "D690437" "D695915" "D695916" "D695917" "D695918" "D695919" "D695920" "D695921" "D695922" "D737523" "D738534").PN. OR ("4315482" "D056913" "D247374" "D256419" "D493319" "D592464" "D651471" "D654870" "D729413" "D761443").URPN.	US-PGPUB; USPAT; USOCR	OR	OFF	2018/11/05 20:27
S8	2	cutlery adj stand.ti.	US-PGPUB; USPAT; USOCR	OR	OFF	2018/11/05 11:42
S7	704	(211/13.1,70.6,70.7,73,74,60.1,70.1,71.01,85.31,85.4,133.5,181.1; 248/37.3,37.6,176.1,175).CCLS. AND ((STEREOSCOPI C TRIMETRIC AXONOMETRIC PICTORIAL PICTORIAL ISOMETRIC OBLIQUE EXPLODED """"THREE DIMENSIONAL"""" perspectiv\$2) with (DRAWING VIEW)).bi. and HOLDER.ti.	US-PGPUB; USPAT; USOCR	OR	OFF	2018/11/02 16:36
S6	58	(206/553,557,562,564; 211/60.1,70.1,70.7; 220/23.83).CCLS. AND ((STEREOSCOPI C TRIMETRIC AXONOMETRIC PICTORIAL PICTORIAL ISOMETRIC OBLIQUE EXPLODED """"THREE DIMENSIONAL"""" perspectiv\$2) with (DRAWING VIEW)).bi. and utensil.ti.	US-PGPUB; USPAT; USOCR	OR	OFF	2018/10/31 16:34
S5	3951	(D19/77,81-86).CCLS.	US-PGPUB; USPAT; USOCR	OR	OFF	2018/10/31 16:33
S4	5363	(D9/420-426,432).CCLS.	US-PGPUB; USPAT; USOCR	OR	OFF	2018/10/31 16:33
S3	1642	(D7/631,637-641,550.1).CCLS.	US-	OR	OFF	2018/10/31

			PGPUB; USPAT; USOCR			16:33
S2	915	(D3/273,274).CCLS.	US- PGPUB; USPAT; USOCR	OR	OFF	2018/10/31 16:33
S1	137	(A47G21/06,14 A47G29/08 B65D43/169 B65D45/00 B67B7/16,44).cpc. and utensil.li.	US- PGPUB; USPAT; USOCR	OR	OFF	2018/10/31 16:33

11/6/2018 3:35:55 PM

C:\Users\jpatyk\Documents\EAST\Workspaces\Holders_10-31-2018.wsp



UNITED STATES PATENT AND TRADEMARK OFFICE

UNITED STATES DEPARTMENT OF COMMERCE
 United States Patent and Trademark Office
 Address: COMMISSIONER FOR PATENTS
 P.O. Box 1450
 Alexandria, Virginia 22313-1450
 www.uspto.gov

APPLICATION NUMBER	FILING or 371(c) DATE	GRP ART UNIT	FIL FEE REC'D	ATTY. DOCKET NO	TOT CLAIMS	IND CLAIMS
29/625,265	11/08/2017	2913	760	VVL001USP	1	1

CONFIRMATION NO. 5612

FILING RECEIPT



139305
 Peretz Chesal & Herrmann, P.L.
 One Biscayne Tower
 2 South Biscayne Boulevard Suite 3700
 Miami, FL 33131

Date Mailed: 11/14/2017

Receipt is acknowledged of this non-provisional patent application. The application will be taken up for examination in due course. Applicant will be notified as to the results of the examination. Any correspondence concerning the application must include the following identification information: the U.S. APPLICATION NUMBER, FILING DATE, NAME OF APPLICANT, and TITLE OF INVENTION. Fees transmitted by check or draft are subject to collection. Please verify the accuracy of the data presented on this receipt. **If an error is noted on this Filing Receipt, please submit a written request for a Filing Receipt Correction. Please provide a copy of this Filing Receipt with the changes noted thereon. If you received a "Notice to File Missing Parts" for this application, please submit any corrections to this Filing Receipt with your reply to the Notice. When the USPTO processes the reply to the Notice, the USPTO will generate another Filing Receipt incorporating the requested corrections**

Inventor(s)

Rui Medeiros Santos, Rotterdam, NETHERLANDS;
 Sandra van Oosterbaan-Rijnen, Barendrecht, NETHERLANDS;
 Delphine Buyse, Voorburg, NETHERLANDS;

Applicant(s)

Vacu Vin Innovations Ltd., Delfgauw, NETHERLANDS;

Power of Attorney: The patent practitioners associated with Customer Number 139305

Domestic Applications for which benefit is claimed - None.

A proper domestic benefit claim must be provided in an Application Data Sheet in order to constitute a claim for domestic benefit. See 37 CFR 1.76 and 1.78.

Foreign Applications for which priority is claimed (You may be eligible to benefit from the **Patent Prosecution Highway** program at the USPTO. Please see <http://www.uspto.gov> for more information.) - None.

Foreign application information must be provided in an Application Data Sheet in order to constitute a claim to foreign priority. See 37 CFR 1.55 and 1.76.

Permission to Access Application via Priority Document Exchange: No

Permission to Access Search Results: Yes

Applicant may provide or rescind an authorization for access using Form PTO/SB/39 or Form PTO/SB/69 as appropriate.

If Required, Foreign Filing License Granted: 11/09/2017

The country code and number of your priority application, to be used for filing abroad under the Paris Convention, is **US 29/625,265**

Projected Publication Date: None, application is not eligible for pre-grant publication

Non-Publication Request: No

Early Publication Request: No

Title

UTENSIL REST

Preliminary Class

D07

Statement under 37 CFR 1.55 or 1.78 for AIA (First Inventor to File) Transition Applications: No

PROTECTING YOUR INVENTION OUTSIDE THE UNITED STATES

Since the rights granted by a U.S. patent extend only throughout the territory of the United States and have no effect in a foreign country, an inventor who wishes patent protection in another country must apply for a patent in a specific country or in regional patent offices. Applicants may wish to consider the filing of an international application under the Patent Cooperation Treaty (PCT). An international (PCT) application generally has the same effect as a regular national patent application in each PCT-member country. The PCT process **simplifies** the filing of patent applications on the same invention in member countries, but **does not result** in a grant of "an international patent" and does not eliminate the need of applicants to file additional documents and fees in countries where patent protection is desired.

Almost every country has its own patent law, and a person desiring a patent in a particular country must make an application for patent in that country in accordance with its particular laws. Since the laws of many countries differ in various respects from the patent law of the United States, applicants are advised to seek guidance from specific foreign countries to ensure that patent rights are not lost prematurely.

Applicants also are advised that in the case of inventions made in the United States, the Director of the USPTO must issue a license before applicants can apply for a patent in a foreign country. The filing of a U.S. patent application serves as a request for a foreign filing license. The application's filing receipt contains further information and guidance as to the status of applicant's license for foreign filing.

Applicants may wish to consult the USPTO booklet, "General Information Concerning Patents" (specifically, the section entitled "Treaties and Foreign Patents") for more information on timeframes and deadlines for filing foreign patent applications. The guide is available either by contacting the USPTO Contact Center at 800-786-9199, or it can be viewed on the USPTO website at <http://www.uspto.gov/web/offices/pac/doc/general/index.html>.

For information on preventing theft of your intellectual property (patents, trademarks and copyrights), you may wish to consult the U.S. Government website, <http://www.stopfakes.gov>. Part of a Department of Commerce initiative, this website includes self-help "toolkits" giving innovators guidance on how to protect intellectual property in specific countries such as China, Korea and Mexico. For questions regarding patent enforcement issues, applicants may call the U.S. Government hotline at 1-866-999-HALT (1-866-999-4258).

LICENSE FOR FOREIGN FILING UNDER
Title 35, United States Code, Section 184
Title 37, Code of Federal Regulations, 5.11 & 5.15

GRANTED

The applicant has been granted a license under 35 U.S.C. 184, if the phrase "IF REQUIRED, FOREIGN FILING LICENSE GRANTED" followed by a date appears on this form. Such licenses are issued in all applications where the conditions for issuance of a license have been met, regardless of whether or not a license may be required as set forth in 37 CFR 5.15. The scope and limitations of this license are set forth in 37 CFR 5.15(a) unless an earlier license has been issued under 37 CFR 5.15(b). The license is subject to revocation upon written notification. The date indicated is the effective date of the license, unless an earlier license of similar scope has been granted under 37 CFR 5.13 or 5.14.

This license is to be retained by the licensee and may be used at any time on or after the effective date thereof unless it is revoked. This license is automatically transferred to any related applications(s) filed under 37 CFR 1.53(d). This license is not retroactive.

The grant of a license does not in any way lessen the responsibility of a licensee for the security of the subject matter as imposed by any Government contract or the provisions of existing laws relating to espionage and the national security or the export of technical data. Licensees should apprise themselves of current regulations especially with respect to certain countries, of other agencies, particularly the Office of Defense Trade Controls, Department of State (with respect to Arms, Munitions and Implements of War (22 CFR 121-128)); the Bureau of Industry and Security, Department of Commerce (15 CFR parts 730-774); the Office of Foreign Assets Control, Department of Treasury (31 CFR Parts 500+) and the Department of Energy.

NOT GRANTED

No license under 35 U.S.C. 184 has been granted at this time, if the phrase "IF REQUIRED, FOREIGN FILING LICENSE GRANTED" DOES NOT appear on this form. Applicant may still petition for a license under 37 CFR 5.12, if a license is desired before the expiration of 6 months from the filing date of the application. If 6 months has lapsed from the filing date of this application and the licensee has not received any indication of a secrecy order under 35 U.S.C. 181, the licensee may foreign file the application pursuant to 37 CFR 5.15(b).

SelectUSA

The United States represents the largest, most dynamic marketplace in the world and is an unparalleled location for business investment, innovation, and commercialization of new technologies. The U.S. offers tremendous resources and advantages for those who invest and manufacture goods here. Through SelectUSA, our nation works to promote and facilitate business investment. SelectUSA provides information assistance to the international investor community; serves as an ombudsman for existing and potential investors; advocates on behalf of U.S. cities, states, and regions competing for global investment; and counsels U.S. economic development organizations on investment attraction best practices. To learn more about why the United States is the best country in the world to develop technology, manufacture products, deliver services, and grow your business, visit <http://www.SelectUSA.gov> or call +1-202-482-6800.

Document code: WFEE

United States Patent and Trademark Office
Sales Receipt for Accounting Date: 11/13/2017

ASAHLE RF #30204899 Mailroom Dt: 11/13/2017 29625265

Credit Card Refund Total: \$180.00

American Express XXXXXXXXXXXXX2050

PTO/AIA/18 (10-17)

Approved for use through 11/30/2017, OMB 0651-0032

U.S. Patent and Trademark Office; U.S. DEPARTMENT OF COMMERCE

Under the Paperwork Reduction Act of 1995 no persons are required to respond to a collection of information unless it displays a valid OMB control number.

<p>DESIGN PATENT APPLICATION TRANSMITTAL</p> <p><i>(Only for new nonprovisional applications under 37 CFR 1.53(b))</i></p>	<p>Attorney Docket No. VVI.001USP</p> <hr/> <p>First Named Inventor Rui Medeiros Santos</p> <hr/> <p>Title UTENSIL REST</p> <hr/> <p>Priority Mail Express® Label No.</p>
---	--

<p>ADDRESS TO: Commissioner for Patents P.O. Box 1450 Alexandria, VA 22313-1450</p>	<p><i>DESIGN V. UTILITY:</i> A "design patent" protects an article's ornamental appearance (e.g., the way an article looks) (35 U.S.C. 171), while a "utility patent" protects the way an article is used and works (35 U.S.C. 101). The ornamental appearance of an article includes its shape/configuration or surface ornamentation upon the article, or both. Both a design and a utility patent may be obtained on an article if invention resides both in its ornamental appearance and its utility. For more information, see MPEP § 1502.01.</p>
---	--

<p>APPLICATION ELEMENTS</p> <p><i>See MPEP chapter 1500 concerning design patent application contents.</i></p>	<p>ACCOMPANYING APPLICATION PARTS</p>
---	--

<p>1. <input type="checkbox"/> Fee Transmittal Form (PTO/SB/17 or equivalent)</p> <p>2. <input type="checkbox"/> Applicant asserts small entity status. See 37 CFR 1.27</p> <p>3. <input type="checkbox"/> Applicant certifies micro entity status. See 37 CFR 1.29. Applicant must attach form PTO/SB/15A or B or equivalent.</p> <p>4. <input checked="" type="checkbox"/> Specification [Total Pages <u>1</u>] (preferred arrangement set forth below, MPEP § 1503.01) - Preamble - Cross References to Related Applications - Statement Regarding Fed sponsored R & D - Description of the figure(s) of the drawings - Feature description - Claim (only one (1) claim permitted, MPEP § 1503.03)</p> <p>5. <input checked="" type="checkbox"/> Drawing(s) [Total Sheets <u>7</u>] See 37 CFR 1.152</p> <p>6. Inventor's Oath or Declaration [Total Pages <u>3</u>] (including substitute statements under 37 CFR 1.64 and assignments serving as an oath or declaration under 37 CFR 1.63(e)) a. <input type="checkbox"/> Newly executed (original or copy) b. <input type="checkbox"/> A copy from a prior application (37 CFR 1.63(d))</p> <p>7. <input checked="" type="checkbox"/> Application Data Sheet *See note below. See 37 CFR 1.76 (PTO/AIA/14 or equivalent)</p>	<p>8. <input checked="" type="checkbox"/> Assignment Papers (cover sheet & document(s))</p> <p>9. <input checked="" type="checkbox"/> 37 CFR 3.73(c) Statement <input checked="" type="checkbox"/> Power of Attorney (when there is an assignee)</p> <p>10. <input type="checkbox"/> English Translation Document (if applicable)</p> <p>11. <input type="checkbox"/> Information Disclosure Statement (IDS) (PTO/SB/08 or PTO-1449) <input type="checkbox"/> Copies of foreign patent documents, publications, and other information</p> <p>12. <input type="checkbox"/> Preliminary Amendment</p> <p>13. <input type="checkbox"/> Return Receipt Postcard (MPEP § 503) (Should be specifically itemized)</p> <p>14. <input type="checkbox"/> Certified Copy of Priority Document(s) (if foreign priority is claimed)</p> <p>15. <input type="checkbox"/> Request for Expedited Examination of a Design Application (37 CFR 1.155) (NOTE: Use "Mail Stop Expedited Design")</p> <p>16. <input type="checkbox"/> Other: _____ _____ _____</p>
---	--

*Note: (1) Benefit claims under 37 CFR 1.78 and foreign priority claims under 1.55 must be included in an Application Data Sheet (ADS).
 (2) For applications filed under 35 U.S.C. 111, the application must contain an ADS specifying the applicant if the applicant is an assignee, person to whom the inventor is under an obligation to assign, or person who otherwise shows sufficient proprietary interest in the matter. See 37 CFR 1.46(b).

17. CORRESPONDENCE ADDRESS

The address associated with Customer Number: 13905 OR Correspondence address below

Name				
Address				
City	State	Zip Code		
Country	Telephone	Email		

Signature	/joseph r. englander/	Date	11/08/2017
Name (Print/Type)	Joseph R. Englander	Registration No. (Attorney/Agent)	38871

This collection of information is required by 37 CFR 1.53(b). The information is required to obtain or retain a benefit by the public which is to file (and by the USPTO to process) an application. Confidentiality is governed by 35 U.S.C. 122 and 37 CFR 1.11 and 1.14. This collection is estimated to take 12 minutes to complete, including gathering, preparing, and submitting the completed application form to the USPTO. Time will vary depending upon the individual case. Any comments on the amount of time you require to complete this form and/or suggestions for reducing this burden, should be sent to the Chief Information Officer, U.S. Patent and Trademark Office, U.S. Department of Commerce, P.O. Box 1450, Alexandria, VA 22313-1450. DO NOT SEND FEES OR COMPLETED FORMS TO THIS ADDRESS. SEND TO: Commissioner for Patents, P.O. Box 1450, Alexandria, VA 22313-1450.

If you need assistance in completing the form, call 1-800-PTO-9199 and select option 2.

Electronic Patent Application Fee Transmittal

Application Number:				
Filing Date:				
Title of Invention:	UTENSIL REST			
First Named Inventor/Applicant Name:	Rui Medeiros Santos			
Filer:	Joseph R. Englander/Erika Montane			
Attorney Docket Number:	VVI.001USP			
Filed as Large Entity				
Filing Fees for Design				
Description	Fee Code	Quantity	Amount	Sub-Total in USD(\$)
Basic Filing:				
DESIGN APPLICATION FILING	1012	1	180	180
Design Search Fee	1112	1	120	120
DESIGN EXAMINATION	1312	1	460	460
DESIGN APPLICATION FILING (CPA)	1017	1	180	180
Pages:				
Claims:				
Miscellaneous-Filing:				
Petition:				

Description	Fee Code	Quantity	Amount	Sub-Total in USD(\$)
Patent-Appeals-and-Interference:				
Post-Allowance-and-Post-Issuance:				
Extension-of-Time:				
Miscellaneous:				
Total in USD (\$)				940

Electronic Acknowledgement Receipt

EFS ID:	30890905
Application Number:	29625265
International Application Number:	
Confirmation Number:	5612
Title of Invention:	UTENSIL REST
First Named Inventor/Applicant Name:	Rui Medeiros Santos
Customer Number:	139305
Filer:	Joseph R. Englander/Erika Montane
Filer Authorized By:	Joseph R. Englander
Attorney Docket Number:	WI.001USP
Receipt Date:	08-NOV-2017
Filing Date:	
Time Stamp:	14:39:09
Application Type:	Design

Payment information:

Submitted with Payment	yes
Payment Type	CARD
Payment was successfully received in RAM	\$940
RAM confirmation Number	110917INTEFSW14403200
Deposit Account	
Authorized User	

The Director of the USPTO is hereby authorized to charge indicated fees and credit any overpayment as follows:

File Listing:

Document Number	Document Description	File Name	File Size(Bytes)/ Message Digest	Multi Part /.zip	Pages (if appl.)
1		PatentApplicationVVI.pdf	1970457 0e9c2df6ee748028642b1f121c7284068321933c	yes	25
Multipart Description/PDF files in .zip description					
	Document Description		Start		End
	Assignee showing of ownership per 37 CFR 3.73		24		25
	Oath or Declaration filed		21		23
	Power of Attorney		20		20
	Drawings-only black and white line drawings		13		19
	Specification		12		12
	Assignee showing of ownership per 37 CFR 3.73		10		11
	Application Data Sheet		2		9
	Transmittal of New Application		1		1
Warnings:					
Information:					
2	Fee Worksheet (SB06)	fee-info.pdf	36328 c89626124ed87d9e3feae03c26b0e250cc018658	no	2
Warnings:					
Information:					
Total Files Size (in bytes):			2006785		

This Acknowledgement Receipt evidences receipt on the noted date by the USPTO of the indicated documents, characterized by the applicant, and including page counts, where applicable. It serves as evidence of receipt similar to a Post Card, as described in MPEP 503.

New Applications Under 35 U.S.C. 111

If a new application is being filed and the application includes the necessary components for a filing date (see 37 CFR 1.53(b)-(d) and MPEP 506), a Filing Receipt (37 CFR 1.54) will be issued in due course and the date shown on this Acknowledgement Receipt will establish the filing date of the application.

National Stage of an International Application under 35 U.S.C. 371

If a timely submission to enter the national stage of an international application is compliant with the conditions of 35 U.S.C. 371 and other applicable requirements a Form PCT/DO/EO/903 indicating acceptance of the application as a national stage submission under 35 U.S.C. 371 will be issued in addition to the Filing Receipt, in due course.

New International Application Filed with the USPTO as a Receiving Office

If a new international application is being filed and the international application includes the necessary components for an international filing date (see PCT Article 11 and MPEP 1810), a Notification of the International Application Number and of the International Filing Date (Form PCT/RO/105) will be issued in due course, subject to prescriptions concerning national security, and the date shown on this Acknowledgement Receipt will establish the international filing date of the application.

ASSIGNMENT

IN CONSIDERATION of the sum of One Dollar (\$1.00), and of other good and valuable consideration paid to the undersigned by the Assignee,

VACU VIN INNOVATIONS LTD.

a private company with limited liability organized under the laws of the Netherlands, domiciled at

Groothandelsweg 1, 2645 EH Delfgauw, The Netherlands

receipt whereof is hereby acknowledged, the undersigned by these presents hereby sells, assigns, transfers, and sets over unto said assignee the entire right, title and interest in and to the invention or improvement in

DESIGN FOR "UTENSIL REST"

said invention being fully described and/or claimed in the application for Letters Patent of the United States of America, executed this date/ these dates, as well as any divisional, continuing, reissue, reexamination, or other patent applications, in and for the United States and all foreign countries, the same to be held and enjoyed by said assignee, its successors, assigns or other legal representatives, to the full ends of the terms for which all Letters Patent therefore may be granted, as fully and entirely as the same would have been held and enjoyed by the undersigned if this assignment and sale had not been made.

AND SAID ASSIGNEE IS HEREBY AUTHORIZED to make application for and to receive Letters Patent for said invention in any of said countries at its election.

AND BY THIS COVENANT the undersigned will execute or procure any further necessary assurance of title to said invention and Letters Patent; and at any time, upon the request of said assignee, will execute and deliver any and all papers that may be necessary or desirable to perfect the title to said invention or any Letters Patent which may be granted therefor to said Assignee, its successors, assigns or other legal representatives, and, upon the request of said assignee, will execute any divisional, continuing, reissue, reexamination, or other applications for patents for said invention, in any country, and will make all rightful oaths and do all lawful acts requisite for aiding, procuring, or maintaining the same or for aiding therein.

AND THE COMMISSIONER of Patents is hereby authorized and requested to issue any and all Letters Patent to the United States for said invention, to said assignee.

SIGNED as indicated.

[Signature]
Buyse, Delphine
Date 1 november 2017

Location: Delfgauw
Witnessed: [Signature]
Name: Patricia A. Laet November 2nd, 2017
(printed or typed) Date

[Signature]
van Oosterbaan-Rijnen, Sandra
Date 1 november 2017

Location: Delfgauw
Witnessed: [Signature]
Name: Arnoldus W. Zeehorst November 2nd, 2017
(printed or typed) Date

[Signature]
Santos, Rui Medeiros
Date 1 NOVEMBER 2017

Location: Delfgauw
Witnessed: [Signature]
Name: Jakob H. Formisna November 2nd, 2017
(printed or typed) Date

PTO/AIA/01 (06-12)

Approved for use through 01/31/2014. OMB 0651-0032
U.S. Patent and Trademark Office, U.S. DEPARTMENT OF COMMERCE

Under the Paperwork Reduction Act of 1995, no persons are required to respond to a collection of information unless it displays a valid OMB control number.

**DECLARATION (37 CFR 1.63) FOR UTILITY OR DESIGN APPLICATION USING AN
APPLICATION DATA SHEET (37 CFR 1.76)**

Title of Invention	UTENSIL REST
<p>As the below named inventor, I hereby declare that:</p> <p>This declaration is directed to: <input checked="" type="checkbox"/> The attached application, or <input type="checkbox"/> United States application or PCT international application number _____ filed on _____</p> <p>The above-identified application was made or authorized to be made by me</p> <p>I believe that I am the original inventor or an original joint inventor of a claimed invention in the application.</p> <p>I hereby acknowledge that any willful false statement made in this declaration is punishable under 18 U.S.C. 1001 by fine or imprisonment of not more than five (5) years, or both.</p> <p style="text-align: center;">WARNING:</p> <p>Petitioner/applicant is cautioned to avoid submitting personal information in documents filed in a patent application that may contribute to identity theft. Personal information such as social security numbers, bank account numbers, or credit card numbers (other than a check or credit card authorization form PTO-2038 submitted for payment purposes) is never required by the USPTO to support a petition or an application. If this type of personal information is included in documents submitted to the USPTO, petitioners/applicants should consider redacting such personal information from the documents before submitting them to the USPTO. Petitioner/applicant is advised that the record of a patent application is available to the public after publication of the application (unless a non-publication request in compliance with 37 CFR 1.213(a) is made in the application) or issuance of a patent. Furthermore, the record from an abandoned application may also be available to the public if the application is referenced in a published application or an issued patent (see 37 CFR 1.14). Checks and credit card authorization forms PTO-2038 submitted for payment purposes are not retained in the application file and therefore are not publicly available.</p>	
LEGAL NAME OF INVENTOR	
Inventor: <u>Sandra van Oosterbaan-Rijnen</u> Date (Optional) : _____	
Signature: 	
<p>Note: An application data sheet (PTO/SB/14 or equivalent), including naming the entire inventive entity, must accompany this form or must have been previously filed. Use an additional PTO/AIA/01 form for each additional inventor.</p>	

This collection of information is required by 35 U.S.C. 115 and 37 CFR 1.63. The information is required to obtain or retain a benefit by the public which is to file (and by the USPTO to process) an application. Confidentiality is governed by 35 U.S.C. 122 and 37 CFR 1.11 and 1.14. This collection is estimated to take 1 minute to complete, including gathering, preparing, and submitting the completed application form to the USPTO. Time will vary depending upon the individual case. Any comments on the amount of time you require to complete this form and/or suggestions for reducing this burden, should be sent to the Chief Information Officer, U.S. Patent and Trademark Office, U.S. Department of Commerce, P.O. Box 1450, Alexandria, VA 22313-1450. DO NOT SEND FEES OR COMPLETED FORMS TO THIS ADDRESS. SEND TO: Commissioner for Patents, P.O. Box 1450, Alexandria, VA 22313-1450.

If you need assistance in completing the form, call 1-800-PTO-9199 and select option 2.

PTO/AIA/01 (06-12)

Approved for use through 01/31/2014 OMB 0551-0032

U.S. Patent and Trademark Office, U.S. DEPARTMENT OF COMMERCE

Under the Paperwork Reduction Act of 1995, no persons are required to respond to a collection of information unless it displays a valid OMB control number.

DECLARATION (37 CFR 1.63) FOR UTILITY OR DESIGN APPLICATION USING AN APPLICATION DATA SHEET (37 CFR 1.76)

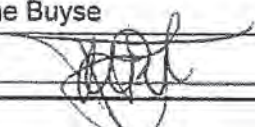
Title of Invention	UTENSIL REST
<p>As the below named inventor, I hereby declare that:</p> <p>This declaration is directed to: <input checked="" type="checkbox"/> The attached application, or <input type="checkbox"/> United States application or PCT international application number _____ filed on _____.</p> <p>The above-identified application was made or authorized to be made by me.</p> <p>I believe that I am the original inventor or an original joint inventor of a claimed invention in the application.</p> <p>I hereby acknowledge that any willful false statement made in this declaration is punishable under 18 U.S.C. 1001 by fine or imprisonment of not more than five (5) years, or both.</p> <p style="text-align: center;">WARNING:</p> <p>Petitioner/applicant is cautioned to avoid submitting personal information in documents filed in a patent application that may contribute to identity theft. Personal information such as social security numbers, bank account numbers, or credit card numbers (other than a check or credit card authorization form PTO-2038 submitted for payment purposes) is never required by the USPTO to support a petition or an application. If this type of personal information is included in documents submitted to the USPTO, petitioners/applicants should consider redacting such personal information from the documents before submitting them to the USPTO. Petitioner/applicant is advised that the record of a patent application is available to the public after publication of the application (unless a non-publication request in compliance with 37 CFR 1.213(a) is made in the application) or issuance of a patent. Furthermore, the record from an abandoned application may also be available to the public if the application is referenced in a published application or an issued patent (see 37 CFR 1.14). Checks and credit card authorization forms PTO-2038 submitted for payment purposes are not retained in the application file and therefore are not publicly available.</p>	
<p>LEGAL NAME OF INVENTOR</p> <p>Inventor: <u>Delphine Buyse</u> Date (Optional): _____</p> <p>Signature: </p>	
<p>Note: An application data sheet (PTO/SB114 or equivalent), including naming the entire inventive entity, must accompany this form or must have been previously filed. Use an additional PTO/AIA/01 form for each additional inventor.</p>	

This collection of information is required by 35 U.S.C. 116 and 37 CFR 1.63. The information is required to obtain or retain a benefit by the public which is to file (and by the USPTO to process) an application. Confidentiality is governed by 35 U.S.C. 122 and 37 CFR 1.11 and 1.14. This collection is estimated to take 1 minute to complete, including gathering, preparing, and submitting the completed application form to the USPTO. Time will vary depending upon the individual case. Any comments on the amount of time you require to complete this form and/or suggestions for reducing this burden, should be sent to the Chief Information Officer, U.S. Patent and Trademark Office, U.S. Department of Commerce, P.O. Box 1450, Alexandria, VA 22313-1450. DO NOT SEND FEES OR COMPLETED FORMS TO THIS ADDRESS. SEND TO: Commissioner for Patents, P.O. Box 1450, Alexandria, VA 22313-1450.

If you need assistance in completing the form, call 1-800-PTO-9199 and select option 2.

PTO/AIA/01 (06-12)

Approved for use through 01/31/2014 OMB 0651-0032
U.S. Patent and Trademark Office, U.S. DEPARTMENT OF COMMERCE

Under the Paperwork Reduction Act of 1995, no persons are required to respond to a collection of information unless it displays a valid OMB control number.

**DECLARATION (37 CFR 1.63) FOR UTILITY OR DESIGN APPLICATION USING AN
APPLICATION DATA SHEET (37 CFR 1.76)**

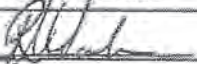
Title of Invention	UTENSIL REST
<p>As the below named inventor, I hereby declare that:</p> <p>This declaration is directed to: <input checked="" type="checkbox"/> The attached application, or <input type="checkbox"/> United States application or PCT international application number _____ filed on _____</p> <p>The above-identified application was made or authorized to be made by me.</p> <p>I believe that I am the original inventor or an original joint inventor of a claimed invention in the application.</p> <p>I hereby acknowledge that any willful false statement made in this declaration is punishable under 18 U.S.C. 1001 by fine or imprisonment of not more than five (5) years, or both.</p> <p style="text-align: center;">WARNING:</p> <p>Petitioner/applicant is cautioned to avoid submitting personal information in documents filed in a patent application that may contribute to identity theft. Personal information such as social security numbers, bank account numbers, or credit card numbers (other than a check or credit card authorization form PTO-2038 submitted for payment purposes) is never required by the USPTO to support a petition or an application. If this type of personal information is included in documents submitted to the USPTO, petitioners/applicants should consider redacting such personal information from the documents before submitting them to the USPTO. Petitioner/applicant is advised that the record of a patent application is available to the public after publication of the application (unless a non-publication request in compliance with 37 CFR 1.213(a) is made in the application) or issuance of a patent. Furthermore, the record from an abandoned application may also be available to the public if the application is referenced in a published application or an issued patent (see 37 CFR 1.14). Checks and credit card authorization forms PTO-2038 submitted for payment purposes are not retained in the application file and therefore are not publicly available.</p>	
LEGAL NAME OF INVENTOR	
Inventor: <u>Rui Medeiros Santos</u> Date (Optional): _____	
Signature: <u></u>	
<p>Note: An application data sheet (PTO/SB/14 or equivalent), including naming the entire inventive entity, must accompany this form or must have been previously filed. Use an additional PTO/AIA/01 form for each additional inventor.</p>	

This collection of information is required by 35 U.S.C. 115 and 37 CFR 1.63. The information is required to obtain or retain a benefit by the public which is to file (and by the USPTO to process) an application. Confidentiality is governed by 35 U.S.C. 122 and 37 CFR 1.11 and 1.14. This collection is estimated to take 1 minute to complete, including gathering, preparing, and submitting the completed application form to the USPTO. Time will vary depending upon the individual case. Any comments on the amount of time you require to complete this form and/or suggestions for reducing this burden, should be sent to the Chief Information Officer, U.S. Patent and Trademark Office, U.S. Department of Commerce, P.O. Box 1450, Alexandria, VA 22313-1450. DO NOT SEND FEES OR COMPLETED FORMS TO THIS ADDRESS. SEND TO: Commissioner for Patents, P.O. Box 1450, Alexandria, VA 22313-1450.

If you need assistance in completing the form, call 1-800-PTO-9199 and select option 2.

PTO/AIA/BO (07-17)
 Approved for use through 01/31/2018. OMB D651-0035
 U.S. Patent and Trademark Office, U.S. DEPARTMENT OF COMMERCE

Under the Paperwork Reduction Act of 1995, no person is required to respond to a collection of information unless it displays a valid OMB control number

POWER OF ATTORNEY TO PROSECUTE APPLICATIONS BEFORE THE USPTO

I hereby revoke all previous powers of attorney given in the application identified in the attached statement under 37 CFR 3.73(c).

I hereby appoint:

Practitioners associated with Customer Number: 139305

OR

Practitioner(s) named below (if more than ten patent practitioners are to be named, then a customer number must be used):

Name	Registration Number

Name	Registration Number

As attorney(s) or agent(s) to represent the undersigned before the United States Patent and Trademark Office (USPTO) in connection with any and all patent applications assigned only to the undersigned according to the USPTO assignment records or assignment documents attached to this form in accordance with 37 CFR 3.73(c).

Please change the correspondence address for the application identified in the attached statement under 37 CFR 3.73(c) to:

The address associated with Customer Number: 139305

OR

Firm or individual name

Address

City State Zip

Country

Telephone Email

Assignee name and address: Vacy Win Innovations Ltd
 Großhandelsweg 1
 20463 Elm Duesen
 The Netherlands

A copy of this form, together with a statement under 37 CFR 3.73(c) (Form PTO/AIA/96 or equivalent) is required to be filed in each application in which this form is used. The statement under 37 CFR 3.73(c) may be completed by one of the practitioners appointed in this form, and must identify the application in which this Power of Attorney is to be filed.

SIGNATURE of Assignee of Record

The individual whose signature and title is supplied below is authorized to act on behalf of the assignee.

Signature 	Date November 1 st , 2017
Name Patrick B.J. Schneider	Telephone +31 651313 209
Title President & CEO	

This collection of information is required by 37 CFR 1.31, 1.32, and 1.33. The information is required to obtain or retain a benefit by the public, which is to update (and by the USPTO to process) the file of a patent or reexamination proceeding. Confidentiality is governed by 35 U.S.C. 122 and 37 CFR 1.11 and 1.14. This collection is estimated to take 18 minutes to complete, including gathering, preparing, and submitting the completed application form to the USPTO. Time will vary depending upon the individual case. Any comments on the amount of time you require to complete this form and/or suggestions for reducing this burden, should be sent to the Chief Information Officer, U.S. Patent and Trademark Office, U.S. Department of Commerce, P.O. Box 1450, Alexandria, VA 22313-1450. DO NOT SEND FEES OR COMPLETED FORMS TO THIS ADDRESS. SEND TO: Commissioner for Patents, P.O. Box 1450, Alexandria, VA 22313-1450.
 If you need assistance in completing the form, call 1-800-PTO-9199 and select option 2.

Title: UTENSIL REST
Applicant: Vacu Vin Innovations, Ltd.
Inventors: Santos, et al.
Sheet 1 of 7

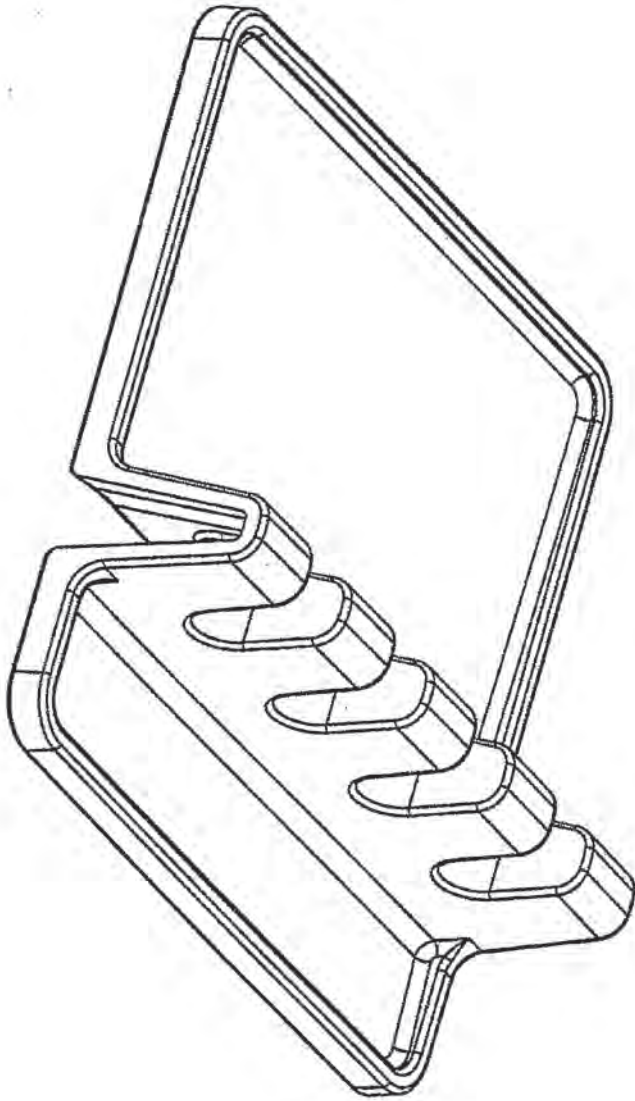

FIGURE 1

Title: UTENSIL REST
Applicant: Vacu Vin Innovations, Ltd.
Inventors: Santos, et al.

Sheet 2 of 7

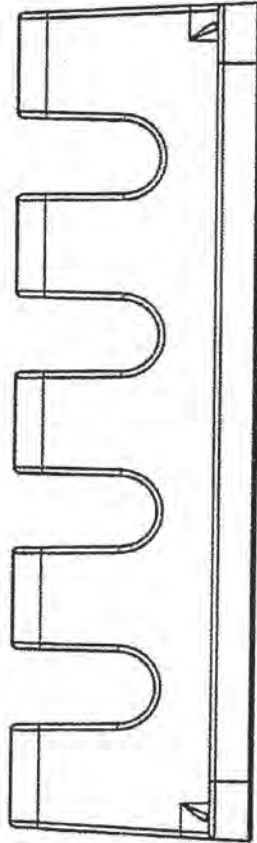

FIGURE 2

Title: UTENSIL REST
Applicant: Vacu Vin Innovations, Ltd.
Inventors: Santos, et al.

Sheet 3 of 7

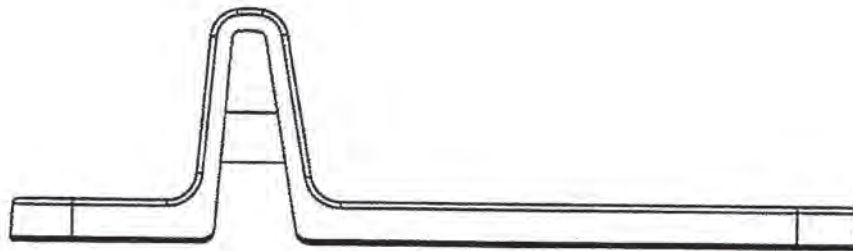

FIGURE 3

Title: UTENSIL REST
Applicant: Vacu Vin Innovations, Ltd.
Inventors: Santos, et al.

Sheet 4 of 7

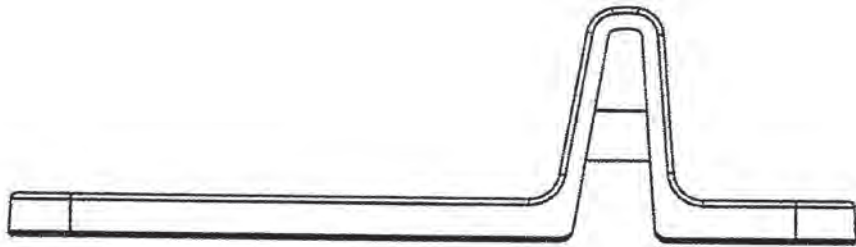

FIGURE 4

Title: UTENSIL REST
Applicant: Vacu Vin Innovations, Ltd.
Inventors: Santos, et al.

Sheet 5 of 7

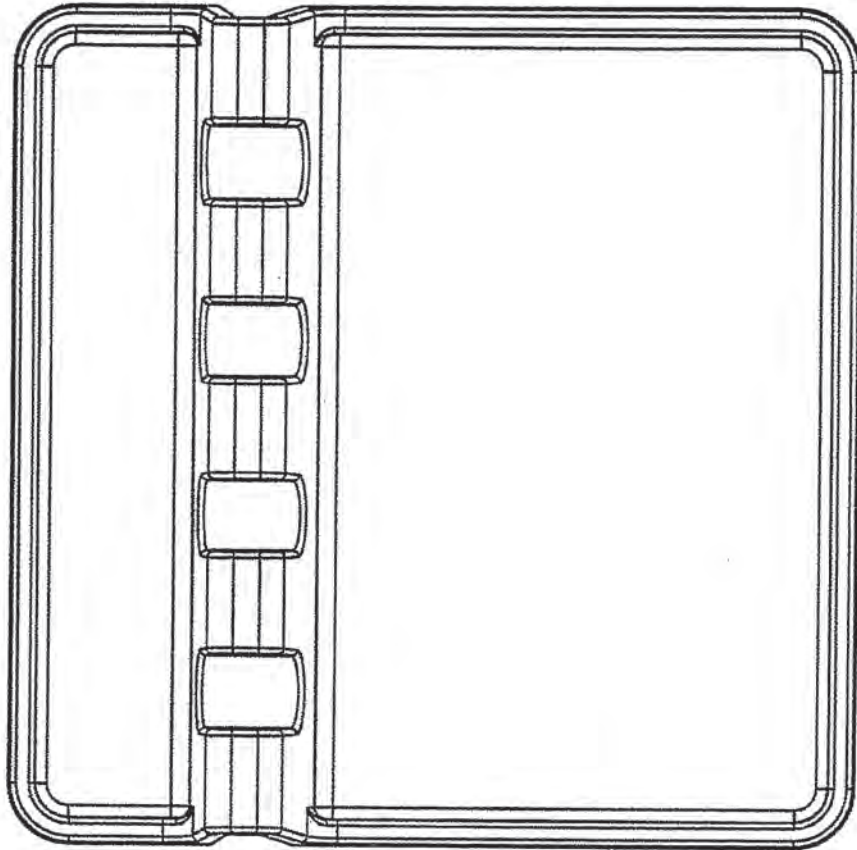

FIGURE 5

Title: UTENSIL REST
Applicant: Vacu Vin Innovations, Ltd.
Inventors: Santos, et al.

Sheet 6 of 7

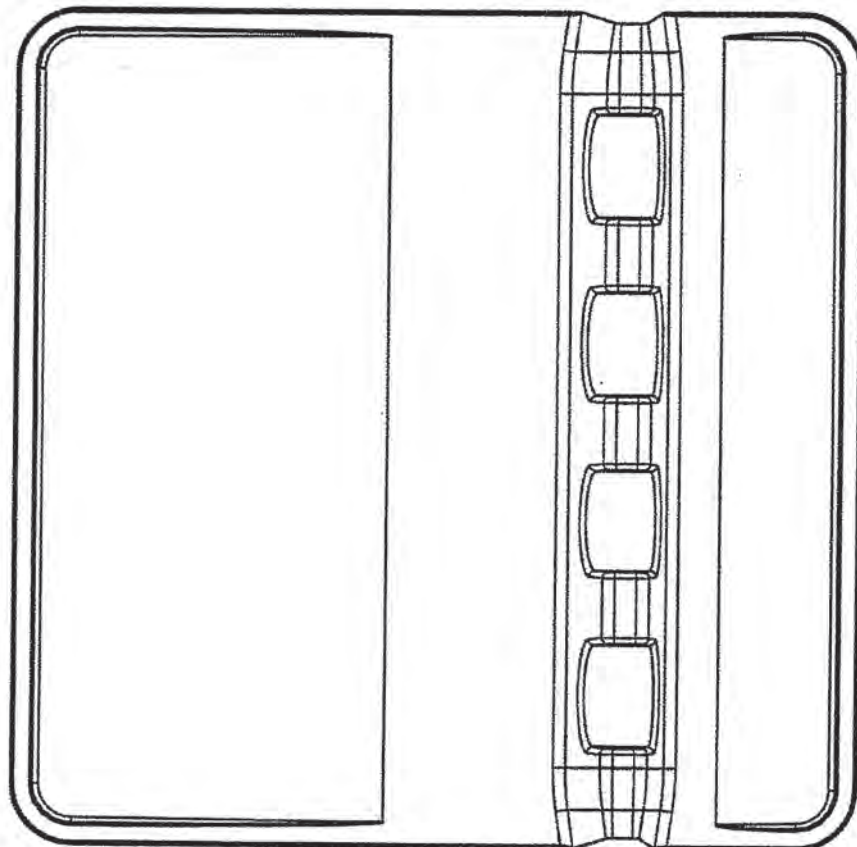

FIGURE 6

FIG. 7

Title: UTENSIL REST
Applicant: Vacu Vin Innovations, Ltd.
Inventors: Santos, et al.

Sheet 7 of 7

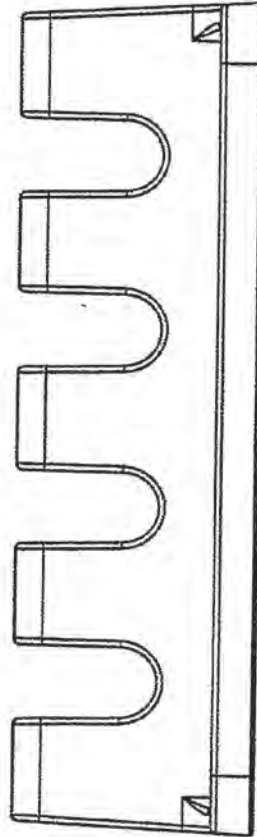

FIGURE 7

UTENSIL REST

TO ALL WHOM IT MAY CONCERN:

BE IT KNOWN that we, Rui Medeiros Santos, residing at Wasbloem 16, 3068 AT Rotterdam, Netherlands, a citizen of Netherlands, Delphine Buyse, residing at Van Halewijnlaan 167, 2274 TG Voorburg, Netherlands, a citizen of Netherlands, and Sandra van Oosterbaan-Rijnen, Boeier 93, 2991 KE Barendrecht, Netherlands, a citizen of Netherlands, have invented a new, original and ornamental design for a "UTENSIL REST" of which the following is a specification, with reference being made to the accompanying drawings, forming a part hereof.

DESCRIPTION OF THE FIGURES OF THE DRAWINGS

FIG. 1 is a top front perspective view of a utensil rest;

FIG. 2 is a front plan view thereof;

FIG. 3 is a right side plan view thereof;

FIG. 4 is a left side plan view thereof;

FIG. 5 is a top view thereof;

FIG. 6 is a bottom view thereof; and

FIG. 7 is a back plan view thereof.

CLAIM

We CLAIM: The ornamental design for a "UTENSIL REST" as shown and described.

STATEMENT UNDER 37 CFR 3.73(c)Applicant/Patent Owner: Vacu Vin Innovations Ltd.

Application No./Patent No.: _____ Filed/Issue Date: _____

Titled: UTENSIL RESTVacu Vin Innovations Ltd., a corporation

(Name of Assignee)

(Type of Assignee, e.g., corporation, partnership, university, government agency, etc.)

states that, for the patent application/patent identified above, it is (choose **one** of options 1, 2, 3 or 4 below):

1. The assignee of the entire right, title, and interest.
2. An assignee of less than the entire right, title, and interest (check applicable box):
- The extent (by percentage) of its ownership interest is _____%. Additional Statement(s) by the owners holding the balance of the interest must be submitted to account for 100% of the ownership interest.
- There are unspecified percentages of ownership. The other parties, including inventors, who together own the entire right, title and interest are:

Additional Statement(s) by the owner(s) holding the balance of the interest must be submitted to account for the entire right, title, and interest.

3. The assignee of an undivided interest in the entirety (a complete assignment from one of the joint inventors was made). The other parties, including inventors, who together own the entire right, title, and interest are:

Additional Statement(s) by the owner(s) holding the balance of the interest must be submitted to account for the entire right, title, and interest.

4. The recipient, via a court proceeding or the like (e.g., bankruptcy, probate), of an undivided interest in the entirety (a complete transfer of ownership interest was made). The certified document(s) showing the transfer is attached.

The interest identified in option 1, 2 or 3 above (not option 4) is evidenced by either (choose **one** of options A or B below):

- A. An assignment from the inventor(s) of the patent application/patent identified above. The assignment was recorded in the United States Patent and Trademark Office at Reel _____, Frame _____, or for which a copy thereof is attached.
- B. A chain of title from the inventor(s), of the patent application/patent identified above, to the current assignee as follows:
1. From: _____ To: _____
The document was recorded in the United States Patent and Trademark Office at Reel _____, Frame _____, or for which a copy thereof is attached.
2. From: _____ To: _____
The document was recorded in the United States Patent and Trademark Office at Reel _____, Frame _____, or for which a copy thereof is attached.

[Page 1 of 2]

This collection of information is required by 37 CFR 3.73(b). The information is required to obtain or retain a benefit by the public which is to file (and by the USPTO to process) an application. Confidentiality is governed by 35 U.S.C. 122 and 37 CFR 1.11 and 1.14. This collection is estimated to take 12 minutes to complete, including gathering, preparing, and submitting the completed application form to the USPTO. Time will vary depending upon the individual case. Any comments on the amount of time you require to complete this form and/or suggestions for reducing this burden, should be sent to the Chief Information Officer, U.S. Patent and Trademark Office, U.S. Department of Commerce, P.O. Box 1450, Alexandria, VA 22313-1450. DO NOT SEND FEES OR COMPLETED FORMS TO THIS ADDRESS. SEND TO: Commissioner for Patents, P.O. Box 1450, Alexandria, VA 22313-1450.

If you need assistance in completing the form, call 1-800-PTO-9199 and select option 2.

Under the Paperwork Reduction Act of 1995, no persons are required to respond to a collection of information unless it displays a valid OMB control number.

STATEMENT UNDER 37 CFR 3.73(c)

3. From: _____ To: _____

The document was recorded in the United States Patent and Trademark Office at
 Reel _____, Frame _____, or for which a copy thereof is attached.

4. From: _____ To: _____

The document was recorded in the United States Patent and Trademark Office at
 Reel _____, Frame _____, or for which a copy thereof is attached.

5. From: _____ To: _____

The document was recorded in the United States Patent and Trademark Office at
 Reel _____, Frame _____, or for which a copy thereof is attached.

6. From: _____ To: _____

The document was recorded in the United States Patent and Trademark Office at
 Reel _____, Frame _____, or for which a copy thereof is attached.

Additional documents in the chain of title are listed on a supplemental sheet(s).

As required by 37 CFR 3.73(c)(1)(i), the documentary evidence of the chain of title from the original owner to the assignee was, or concurrently is being, submitted for recordation pursuant to 37 CFR 3.11.

[NOTE: A separate copy (i.e., a true copy of the original assignment document(s)) must be submitted to Assignment Division in accordance with 37 CFR Part 3, to record the assignment in the records of the USPTO. See MPEP 302.08]

The undersigned (whose title is supplied below) is authorized to act on behalf of the assignee.

/joseph r. englander/

11/08/2017

Signature

Date

Joseph R. Englander

38871

Printed or Typed Name

Title or Registration Number

Under the Paperwork Reduction Act of 1995, no persons are required to respond to a collection of information unless it contains a valid OMB control number.

Application Data Sheet 37 CFR 1.76		Attorney Docket Number	VVI.001USP
		Application Number	
Title of Invention	UTENSIL REST		
<p>The application data sheet is part of the provisional or nonprovisional application for which it is being submitted. The following form contains the bibliographic data arranged in a format specified by the United States Patent and Trademark Office as outlined in 37 CFR 1.76. This document may be completed electronically and submitted to the Office in electronic format using the Electronic Filing System (EFS) or the document may be printed and included in a paper filed application.</p>			

Secrecy Order 37 CFR 5.2:

<input type="checkbox"/>	Portions or all of the application associated with this Application Data Sheet may fall under a Secrecy Order pursuant to 37 CFR 5.2 (Paper filers only. Applications that fall under Secrecy Order may not be filed electronically.)
--------------------------	---

Inventor Information:

Inventor 1					Remove
Legal Name					
Prefix	Given Name	Middle Name	Family Name	Suffix	
	Rui	Medeiros			
Residence Information (Select One) <input type="radio"/> US Residency <input checked="" type="radio"/> Non US Residency <input type="radio"/> Active US Military Service					
City	Rotterdam	Country of Residence ⁱ	NL		
Mailing Address of Inventor:					
Address 1	Wasbloem 16				
Address 2					
City	Rotterdam	State/Province			
Postal Code	3068 AT	Country ⁱ	NL		
Inventor 2					Remove
Legal Name					
Prefix	Given Name	Middle Name	Family Name	Suffix	
	Sandra		van Oosterbaan-Rijnen		
Residence Information (Select One) <input type="radio"/> US Residency <input checked="" type="radio"/> Non US Residency <input type="radio"/> Active US Military Service					
City	Barendrecht	Country of Residence ⁱ	NL		
Mailing Address of Inventor:					
Address 1	Boeier 93				
Address 2					
City	Barendrecht	State/Province			
Postal Code	2991 KE	Country ⁱ	NL		
Inventor 3					Remove
Legal Name					

Under the Paperwork Reduction Act of 1995, no persons are required to respond to a collection of information unless it contains a valid OMB control number.

Application Data Sheet 37 CFR 1.76		Attorney Docket Number	VVI.001USP
		Application Number	
Title of Invention	UTENSIL REST		

Prefix	Given Name	Middle Name	Family Name	Suffix
	Delphine		Buyse	
Residence Information (Select One) <input type="radio"/> US Residency <input checked="" type="radio"/> Non US Residency <input type="radio"/> Active US Military Service				
City	Voorburg	Country of Residence	i	NL

Mailing Address of Inventor:

Address 1	Van Halewijnlaan 167		
Address 2			
City	Voorburg	State/Province	
Postal Code	2274 TG	Country i	NL

All Inventors Must Be Listed - Additional Inventor Information blocks may be generated within this form by selecting the **Add** button.

Correspondence Information:

Enter either Customer Number or complete the Correspondence Information section below.
For further information see 37 CFR 1.33(a).

An Address is being provided for the correspondence information of this application.

Customer Number	139305		
Email Address	patents@pch-iplaw.com	<input type="button" value="Add Email"/>	<input type="button" value="Remove Email"/>
Email Address	jenglander@pch-iplaw.com	<input type="button" value="Add Email"/>	<input type="button" value="Remove Email"/>

Application Information:

Title of the Invention	UTENSIL REST		
Attorney Docket Number	VVI.001USP	Small Entity Status Claimed	<input type="checkbox"/>
Application Type	Nonprovisional		
Subject Matter	Design		
Total Number of Drawing Sheets (if any)	7	Suggested Figure for Publication (if any)	1

Filing By Reference:

Only complete this section when filing an application by reference under 35 U.S.C. 111(c) and 37 CFR 1.57(a). Do not complete this section if application papers including a specification and any drawings are being filed. Any domestic benefit or foreign priority information must be provided in the appropriate section(s) below (i.e., "Domestic Benefit/National Stage Information" and "Foreign Priority Information").

For the purposes of a filing date under 37 CFR 1.53(b), the description and any drawings of the present application are replaced by this

Application number of the previously filed application	Filing date (YYYY-MM-DD)	Intellectual Property Authority or Country

Under the Paperwork Reduction Act of 1995, no persons are required to respond to a collection of information unless it contains a valid OMB control number.

Application Data Sheet 37 CFR 1.76	Attorney Docket Number	VVI.001USP
	Application Number	
Title of Invention	UTENSIL REST	

Publication Information:
 Request Early Publication (Fee required at time of Request 37 CFR 1.219)

 Request Not to Publish. I hereby request that the attached application not be published under 35 U.S.C. 122(b) and certify that the invention disclosed in the attached application **has not and will not be** the subject of an application filed in another country, or under a multilateral international agreement, that requires publication at eighteen months after filing.
Representative Information:

Representative information should be provided for all practitioners having a power of attorney in the application. Providing this information in the Application Data Sheet does not constitute a power of attorney in the application (see 37 CFR 1.32). Either enter Customer Number or complete the Representative Name section below. If both sections are completed the customer Number will be used for the Representative Information during processing.

Please Select One:	<input checked="" type="radio"/> Customer Number	<input type="radio"/> US Patent Practitioner	<input type="radio"/> Limited Recognition (37 CFR 11.9)
Customer Number	139305		

Domestic Benefit/National Stage Information:

This section allows for the applicant to either claim benefit under 35 U.S.C. 119(e), 120, 121, 365(c), or 386(c) or indicate National Stage entry from a PCT application. Providing benefit claim information in the Application Data Sheet constitutes the specific reference required by 35 U.S.C. 119(e) or 120, and 37 CFR 1.78.

When referring to the current application, please leave the "Application Number" field blank.

Prior Application Status			Remove
Application Number	Continuity Type	Prior Application Number	Filing or 371(c) Date (YYYY-MM-DD)

Additional Domestic Benefit/National Stage Data may be generated within this form by selecting the **Add** button.

Foreign Priority Information:

This section allows for the applicant to claim priority to a foreign application. Providing this information in the application data sheet constitutes the claim for priority as required by 35 U.S.C. 119(b) and 37 CFR 1.55. When priority is claimed to a foreign application that is eligible for retrieval under the priority document exchange program (PDX), the information will be used by the Office to automatically attempt retrieval pursuant to 37 CFR 1.55(i)(1) and (2). Under the PDX program, applicant bears the ultimate responsibility for ensuring that a copy of the foreign application is received by the Office from the participating foreign intellectual property office, or a certified copy of the foreign priority application is filed, within the time period specified in 37 CFR 1.55(g)(1).

Under the Paperwork Reduction Act of 1995, no persons are required to respond to a collection of information unless it contains a valid OMB control number.

Application Data Sheet 37 CFR 1.76		Attorney Docket Number	VVI.001USP
		Application Number	
Title of Invention	UTENSIL REST		
Application Number	Country ⁱ	Filing Date (YYYY-MM-DD)	<input type="button" value="Remove"/> Access Code ⁱ (if applicable)
Additional Foreign Priority Data may be generated within this form by selecting the Add button.			

Statement under 37 CFR 1.55 or 1.78 for AIA (First Inventor to File) Transition Applications

<input type="checkbox"/> This application (1) claims priority to or the benefit of an application filed before March 16, 2013 and (2) also contains, or contained at any time, a claim to a claimed invention that has an effective filing date on or after March 16, 2013. NOTE: By providing this statement under 37 CFR 1.55 or 1.78, this application, with a filing date on or after March 16, 2013, will be examined under the first inventor to file provisions of the AIA.

Under the Paperwork Reduction Act of 1995, no persons are required to respond to a collection of information unless it contains a valid OMB control number.

Application Data Sheet 37 CFR 1.76		Attorney Docket Number	VVI.001USP
		Application Number	
Title of Invention	UTENSIL REST		

Authorization or Opt-Out of Authorization to Permit Access:

When this Application Data Sheet is properly signed and filed with the application, applicant has provided written authority to permit a participating foreign intellectual property (IP) office access to the instant application-as-filed (see paragraph A in subsection 1 below) and the European Patent Office (EPO) access to any search results from the instant application (see paragraph B in subsection 1 below).

Should applicant choose not to provide an authorization identified in subsection 1 below, applicant **must opt-out** of the authorization by checking the corresponding box A or B or both in subsection 2 below.

NOTE: This section of the Application Data Sheet is **ONLY** reviewed and processed with the **INITIAL** filing of an application. After the initial filing of an application, an Application Data Sheet cannot be used to provide or rescind authorization for access by a foreign IP office(s). Instead, Form PTO/SB/39 or PTO/SB/69 must be used as appropriate.

1. Authorization to Permit Access by a Foreign Intellectual Property Office(s)

A. Priority Document Exchange (PDX) - Unless box A in subsection 2 (opt-out of authorization) is checked, the undersigned hereby **grants the USPTO authority** to provide the European Patent Office (EPO), the Japan Patent Office (JPO), the Korean Intellectual Property Office (KIPO), the State Intellectual Property Office of the People's Republic of China (SIPO), the World Intellectual Property Organization (WIPO), and any other foreign intellectual property office participating with the USPTO in a bilateral or multilateral priority document exchange agreement in which a foreign application claiming priority to the instant patent application is filed, access to: (1) the instant patent application-as-filed and its related bibliographic data, (2) any foreign or domestic application to which priority or benefit is claimed by the instant application and its related bibliographic data, and (3) the date of filing of this Authorization. See 37 CFR 1.14(h)(1).

B. Search Results from U.S. Application to EPO- Unless box B in subsection 2 (opt-out of authorization) is checked, the undersigned hereby **grants the USPTO authority** to provide the EPO access to the bibliographic data and search results from the instant patent application when a European patent application claiming priority to the instant patent application is filed. See 37 CFR 1.14(h)(2).

The applicant is reminded that the EPO's Rule 141(1) EPC (European Patent Convention) requires applicants to submit a copy of search results from the instant application without delay in a European patent application that claims priority to the instant application.

2. Opt-Out of Authorizations to Permit Access by a Foreign Intellectual Property Office(s)

A. Applicant **DOES NOT** authorize the USPTO to permit a participating foreign IP office access to the instant application-as-filed. If this box is checked, the USPTO will not be providing a participating foreign IP office with any documents and information identified in subsection 1A above.

B. Applicant **DOES NOT** authorize the USPTO to transmit to the EPO any search results from the instant patent application. If this box is checked, the USPTO will not be providing the EPO with search results from the instant application.

NOTE: Once the application has published or is otherwise publicly available, the USPTO may provide access to the application in accordance with 37 CFR 1.14.

Under the Paperwork Reduction Act of 1995, no persons are required to respond to a collection of information unless it contains a valid OMB control number.

Application Data Sheet 37 CFR 1.76		Attorney Docket Number	VVI.001USP
		Application Number	
Title of Invention	UTENSIL REST		

Applicant Information:

Providing assignment information in this section does not substitute for compliance with any requirement of part 3 of Title 37 of CFR to have an assignment recorded by the Office.

Applicant 1

If the applicant is the inventor (or the remaining joint inventor or inventors under 37 CFR 1.45), this section should not be completed. The information to be provided in this section is the name and address of the legal representative who is the applicant under 37 CFR 1.43; or the name and address of the assignee, person to whom the inventor is under an obligation to assign the invention, or person who otherwise shows sufficient proprietary interest in the matter who is the applicant under 37 CFR 1.46. If the applicant is an applicant under 37 CFR 1.46 (assignee, person to whom the inventor is obligated to assign, or person who otherwise shows sufficient proprietary interest) together with one or more joint inventors, then the joint inventor or inventors who are also the applicant should be identified in this section.

Assignee Legal Representative under 35 U.S.C. 117 Joint Inventor

Person to whom the inventor is obligated to assign. Person who shows sufficient proprietary interest

If applicant is the legal representative, indicate the authority to file the patent application, the inventor is:

Name of the Deceased or Legally Incapacitated Inventor:

If the Applicant is an Organization check here.

Organization Name Vacu Vin Innovations Ltd.

Mailing Address Information For Applicant:

Address 1 Groothandelsweg 1

Address 2

City Delfgauw **State/Province**

Country NL **Postal Code** 2645 EH

Phone Number **Fax Number**

Email Address

Additional Applicant Data may be generated within this form by selecting the Add button.

Assignee Information including Non-Applicant Assignee Information:

Providing assignment information in this section does not substitute for compliance with any requirement of part 3 of Title 37 of CFR to have an assignment recorded by the Office.

Under the Paperwork Reduction Act of 1995, no persons are required to respond to a collection of information unless it contains a valid OMB control number.

Application Data Sheet 37 CFR 1.76		Attorney Docket Number	VVI.001USP
		Application Number	
Title of Invention	UTENSIL REST		

Assignee 1

Complete this section if assignee information, including non-applicant assignee information, is desired to be included on the patent application publication. An assignee-applicant identified in the "Applicant Information" section will appear on the patent application publication as an applicant. For an assignee-applicant, complete this section only if identification as an assignee is also desired on the patent application publication.

Signature:

If the Assignee or Non-Applicant Assignee is an Organization check here.

Organization Name	Vacu Vin Innovations Ltd.
-------------------	---------------------------

Mailing Address Information For Assignee including Non-Applicant Assignee:

Address 1		Groothandelsweg 1	
Address 2			
City		Delfgauw	State/Province
Country i	NL	Postal Code	2645 EH
Phone Number		Fax Number	
Email Address			

Additional Assignee or Non-Applicant Assignee Data may be generated within this form by selecting the Add button.

Signature:

NOTE: This Application Data Sheet must be signed in accordance with 37 CFR 1.33(b). However, if this Application Data Sheet is submitted with the INITIAL filing of the application and either box A or B is not checked in subsection 2 of the "Authorization or Opt-Out of Authorization to Permit Access" section, then this form must also be signed in accordance with 37 CFR 1.14(c). This Application Data Sheet must be signed by a patent practitioner if one or more of the applicants is a **juristic entity** (e.g., corporation or association). If the applicant is two or more joint inventors, this form must be signed by a patent practitioner, **all** joint inventors who are the applicant, or one or more joint inventor-applicants who have been given power of attorney (e.g., see USPTO Form PTO/AIA/81) on behalf of **all** joint inventor-applicants. See 37 CFR 1.4(d) for the manner of making signatures and certifications.

Signature	/joseph r. englander/		Date (YYYY-MM-DD)	2017-11-08	
First Name	Joseph	Last Name	Englander	Registration Number	38871

Additional Signature may be generated within this form by selecting the Add button.

Under the Paperwork Reduction Act of 1995, no persons are required to respond to a collection of information unless it contains a valid OMB control number.

Application Data Sheet 37 CFR 1.76	Attorney Docket Number	VVI.001USP
	Application Number	
Title of Invention	UTENSIL REST	

This collection of information is required by 37 CFR 1.76. The information is required to obtain or retain a benefit by the public which is to file (and by the USPTO to process) an application. Confidentiality is governed by 35 U.S.C. 122 and 37 CFR 1.14. This collection is estimated to take 23 minutes to complete, including gathering, preparing, and submitting the completed application data sheet form to the USPTO. Time will vary depending upon the individual case. Any comments on the amount of time you require to complete this form and/or suggestions for reducing this burden, should be sent to the Chief Information Officer, U.S. Patent and Trademark Office, U.S. Department of Commerce, P.O. Box 1450, Alexandria, VA 22313-1450. DO NOT SEND FEES OR COMPLETED FORMS TO THIS ADDRESS. **SEND TO: Commissioner for Patents, P.O. Box 1450, Alexandria, VA 22313-1450.**

DocCode – SCORE

SCORE Placeholder Sheet for IFW Content

Application Number: 29625265

Document Date: 11/08/2017

The presence of this form in the IFW record indicates that the following document type was received in electronic format on the date identified above. This content is stored in the SCORE database.

Since this was an electronic submission, there is no physical artifact folder, no artifact folder is recorded in PALM, and no paper documents or physical media exist. The TIFF images in the IFW record were created from the original documents that are stored in SCORE.

- Drawing

At the time of document entry (noted above):

- USPTO employees may access SCORE content via eDAN using the Supplemental Content tab, or via the SCORE web page.
- External customers may access SCORE content via PAIR using the Supplemental Content tab.

Document code: WFEE

United States Patent and Trademark Office
Sales Receipt for Accounting Date: 11/13/2017

ASAHLE	ADJ #00000007	Mailroom Dt: 11/08/2017
	Seq No: 979	Sales Acctg Dt: 11/09/2017 29625265
	04 FC : 1017	-180.00 OP

From: Amazon <notice@amazon.com>

Date: Sat, May 13, 2023 at 7:34 AM

Subject: Notice: Policy Warning

To: <callmebrandon@gmail.com>

Hello,

We removed some of your listings because we received a report from a rights owner alleging that they infringe on the rights owner's patent. The rights owner communication about the alleged infringement and the listings we removed are at the bottom of this message.

Why did this happen?

We received a report from a rights owner alleging that one or more of your listings may be infringing the intellectual property rights of others. Listing content infringing on the intellectual property of others is against our policies.

We're here to help.

If you need help understanding why your listings may infringe the intellectual property of others, please search for "Intellectual Property Violations" in Seller Central Help: <https://sellercentral.amazon.com/gp/help/external/201361070>

How do I reactivate my listing?

To reactivate your listing, you may provide the following:
-- A letter of authorization or a licensing agreement from the manufacturer or rights owner demonstrating that your product sales are lawful. External links are not accepted. For security reasons, we only accept attachments in the following file formats: .jpeg, .jpg, .pjpeg, .gif, .png, .tiff.

-- An invoice to indicate that your products are original and are purchased from the rights owner directly or from an authorized distributor and are not infringing the patent claimed by the rights owner. You can find the contact information of the rights owner at the bottom of this message.

How do I submit this information?

Go to Received Intellectual Property Complaints under the Product Policy Compliance section in Account Health: https://sellercentral.amazon.com/performance/dashboard?ref=ah_em_mpa

Locate the deactivation record for this product listing. Click on the Appeal button next to the listing deactivation record to submit information necessary to reactivate your listing.

Have your listings been removed in error?

If you have never sold or listed the product, please reach out to us and tell us.

If you think that the rights owner has made an error in sending the notice, please reach out to the rights owner and ask them to submit a retraction of this notice. We may only accept retractions that the rights owner submits to us directly. We do not accept forwarded or attached retractions.

These are the rights owner's contact details:

-- Michiel

— mpereira@vacuvin.com

For any other reason, please explain to us why you were warned in error so that we can investigate the case.

What happens if I do not provide the requested information?
If we do not receive the requested information, your listings will remain inactive.

If you do not provide the information within 60 days, you will receive a request to remove the inventory associated with these listings per our removal policy (<https://sellercentral.amazon.com/gp/help/202000820>). Failure to address this request can lead to destruction of your inventory.

Rights owner communication: This ASINs is an exact copy of our product – please delete this ASINs from Amazon. Please find the patent number attached.

ASIN: B0874SHJFX

B0874S275K

B0874S11MY

Infringement type: Patent

Patent Number: D904832S

Complaint ID: 12737922331

To view your account performance, go to the "Account Health" page in Seller Central:

https://sellercentral.amazon.com/performance/dashboard?reftag=email_appeal

Alternatively, select "Account Health" on the home screen of the Amazon Seller app on your iOS or Android device. The Account Health dashboard shows how well your account is performing against the performance metrics and policies required to sell on Amazon.

— Download the iOS app:

<https://itunes.apple.com/us/app/amazon-seller/id794141485>

<https://itunes.apple.com/us/app/amazon-seller/id794141485>

— Download the Android app:

https://play.google.com/store/apps/details?id=com.amazon.sellermobile.android&hl=en_US

https://play.google.com/store/apps/details?id=com.amazon.sellermobile.android&hl=en_US

https://play.google.com/store/apps/details?id=com.amazon.sellermobile.android&hl=en_US

https://play.google.com/store/apps/details?id=com.amazon.sellermobile.android&hl=en_US

[Amazon.com](https://www.amazon.com)

From: Amazon <notice@amazon.com>

Date: Mon, Jul 3, 2023 at 3:20 AM

Subject: Notice: Policy Warning

To: <callmebrandon@gmail.com>

Hello ,

We removed some of your listings because we received a report from a rights owner alleging that they infringe on the rights owner's patent. The rights owner communication about the alleged infringement and the listings we removed are at the bottom of this message.

Why did this happen?

We received a report from a rights owner alleging that one or more of your listings may be infringing the intellectual property rights of others. Listing content infringing on the intellectual property of others is against our policies.

We're here to help.

If you need help understanding why your listings may infringe the intellectual property of others, please search for "Intellectual Property Violations" in Seller Central Help: <https://sellercentral.amazon.com/gp/help/external/201361070>

How do I reactivate my listing?

To reactivate your listing, you may provide the following:
— A letter of authorization or a licensing agreement from the manufacturer or rights owner demonstrating that your product sales are lawful. External links are not accepted. For security reasons, we only accept attachments in the following file formats: .jpeg, .jpg, .png, .gif, .tiff.

— An invoice to indicate that your products are original and are purchased from the rights owner directly or from an authorized distributor and are not infringing the patent claimed by the rights owner. You can find the contact information of the rights owner at the bottom of this message.

How do I submit this information?

Go to Received Intellectual Property Complaints under the Product Policy Compliance section in Account Health: https://sellercentral.amazon.com/performance/dashboard?ref=ah_em_mpa

Locate the deactivation record for this product listing. Click on the Appeal button next to the listing deactivation record to submit information necessary to reactivate your listing.

Have your listings been removed in error?

If you have never sold or listed the product, please reach out to us and tell us.

If you think that the rights owner has made an error in sending the notice, please reach out to the rights owner and ask them to submit a retraction of this notice. We may only accept retractions that the rights owner submits to us directly. We do not accept forwarded or attached retractions.

These are the rights owner's contact details:

vacuvin-bp@amzwatchdog.com

For any other reason, please explain to us why you were warned in error so that we can investigate the case.

What happens if I do not provide the requested information? If we do not receive the requested information, your listings will remain inactive.

If you do not provide the information within 60 days, you will receive a request to remove the inventory associated with these listings per our removal policy (<https://sellercentral.amazon.com/gp/help/202000820>). Failure to address this request can lead to destruction of your inventory.

Rights owner communication: I am writing on behalf of Vacu Vin Innovations, Ltd., the rightful owner of design patent number USD904832S1 ("the Patent") registered with the United States Patent and Trademark Office (USPTO). It has recently come to our attention that multiple sellers on your platform are selling products that infringe on this patent. These infringements are a direct violation of our intellectual property rights.

The patent in question relates to an ornamental design of a utensil rest. A record of our patent can be found in the public database of USPTO at the following link: <https://patents.google.com/patent/USD904832S1>.

We have examined the listings and the product images provided, and we believe, in good faith, that the items being sold by these sellers are in clear violation of our patent rights.

As a result, we request your immediate assistance in the removal of these listings.

We understand that Amazon respects intellectual property rights and takes patent infringement seriously. By taking immediate action, you will assist us in preventing the further unauthorized use of our patented design.

This letter does not constitute an exhaustive statement of AMZ Watchdog's nor Vacu Vin Innovations, LTD.'s rights, remedies, claims or defenses, all of which are expressly reserved.

Thank you for your prompt attention to this serious matter.

Yours sincerely,

Chris Keef
Sr. VP Brand Enforcement
AMZ Watchdog
chriskeef@amzwatchdog.com

ASIN: B0874SHJFX
Infringement type: Patent
Patent: Patent Number: D904832S1
Complaint ID: 13170282501

To view your account performance, go to the "Account Health" page in Seller Central:

https://sellercentral.amazon.com/performance/dashboard?reftag=email_appeal

Alternatively, select "Account Health" on the home screen of the Amazon Seller app on your iOS or Android device. The Account Health dashboard shows how well your account is performing against the performance metrics and policies required to sell on Amazon.

— Download the iOS app:

<https://itunes.apple.com/us/app/amazon-seller/id794141485>

<https://itunes.apple.com/us/app/amazon-seller/id794141485>

— Download the Android app:

https://play.google.com/store/apps/details?id=com.amazon.sellermobile.android&hl=en_US

https://play.google.com/store/apps/details?id=com.amazon.sellermobile.android&hl=en_US

https://play.google.com/store/apps/details?id=com.amazon.sellermobile.android&hl=en_US

https://play.google.com/store/apps/details?id=com.amazon.sellermobile.android&hl=en_US

[Amazon.com](https://www.amazon.com)

From: Amazon <notice@amazon.com>
Date: Tue, Jul 4, 2023, 10:00 PM
Subject: Notice: Policy Warning
To: <callmebrandon@gmail.com>

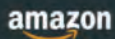

Hello,

We removed some of your listings because we received a report from a rights owner that they infringe the rights owner's patent. The rights owner communication about the alleged infringement and the listings we removed are at the bottom of this message.

Why did this happen?

We received a report from a rights owner alleging that one or more of your listings may be infringing the intellectual property rights of others. Listing content infringing on the intellectual property of others is against our policies.

We're here to help.

If you need help understanding why your listings may infringe the intellectual property of others, please search for "Intellectual Property Violations" in Seller Central Help (<https://sellercentral.amazon.com/gp/help/external/201361070>).

How do I reactivate my listing?

To reactivate your listing you may provide the following:
— A letter of authorization or a licensing agreement from the manufacturer or rights owner demonstrating that your product sales are lawful. External links are not accepted. For security reasons, we only accept attachments in the following file formats: .jpeg, .jpg, .jpeg, .gif, .png, .tiff.

How do I submit this information?

Go to Received Intellectual Property Complaints under the Product Policy Compliance section in account health (https://sellercentral.amazon.com/performance/dashboard?ref=ah_em_mpa) and locate the deactivation record for this product listing. Click on the Appeal button next to the listing deactivation record to submit information necessary to reactivate your listing.

Have your listings been removed in error?

If you have never sold or listed the product, please reach out to us and tell us.

If you think that the rights owner has made an error in sending the notice, please reach out to the rights owner and ask for a retraction of the notice. To retract the complaint, the rights owner must send the retraction to us at notice-retraction@amazon.com or use the retraction function in Brand Registry.

These are the rights owner's contact details:

Brand Protection
vacuvin-bp@amzwatchdog.com

We can only accept retractions if the rights owner clearly states that they made an error. For any other reason, please explain to us why you were warned in error so that we can investigate the case.

What happens if I do not provide the requested information?

If we do not receive the requested information, your listings will remain inactive.

If you do not provide the information within 60 days, you will receive a request to remove the inventory associated with these listings per our removal policy (<https://sellercentral.amazon.com/gp/help/202000820>). Failure to address this request can lead to destruction of your inventory.

Rights owner communication:

I am writing on behalf of Vacu Vin Innovations, Ltd., the rightful owner of design patent number USD904832S1 ("the Patent") registered with the United States Patent and Trademark Office (USPTO). It has recently come to our attention that multiple sellers on your platform are selling products that infringe on this patent. These infringements are a direct violation of our intellectual property rights.

The patent in question relates to an ornamental design of a utensil rest. A record of our patent can be found in the public database of USPTO at the following link: <https://patents.google.com/patent/USD904832S1>.

We have examined the listings and the product images provided, and we believe, in good faith, that the items being sold by these sellers are in clear violation of our patent rights, as they are selling IDENTICAL ITEMS without our authorization

As a result, we request your immediate assistance in the removal of these listings.

We understand that Amazon respects intellectual property rights and takes patent infringement seriously. By taking immediate action, you will assist us in preventing the further unauthorized use of our patented design.

This letter does not constitute an exhaustive statement of AMZ Watchdog's nor Vacu Vin Innovations, LTD.'s rights, remedies, claims or defenses, all of which are expressly reserved.

Thank you for your prompt attention to this serious matter.

ASIN:B08745HJFX
B08745275K
B0874511MY
Infringement type: Patent
Patent: \${Patent Number: D904832S1
Complaint ID: 13183893311

You can view your account performance (https://sellercentral.amazon.com/performance/dashboard?reftag=email_warn) or select Account Health on the home screen of the Amazon Seller app on your iOS or Android device. The Account Health dashboard shows how well your account is performing against the performance metrics and policies required to sell on Amazon.

-- iOS: <https://itunes.apple.com/us/app/amazon-seller/id794141485>
-- Android: <https://play.google.com/store/apps/details?id=com.amazon.sellermobile.android&hl=en>

6:37
LTE 100%

sellercentral.amazon.com

amazon
Cooler Kitchen Kitchenware | United ... Search

Shipments
Account Health

Product Policy Compliance [Leave feedback](#)

Product Policy Violations: 6

January 9, 2023 - July 7, 2023

Target: 0 Issues

Amazon policies maintain a store that is safe for buyers and fair to sellers. Violations of these policies may result in content removal or account deactivation. Below is a record of all listings associated with your account that violate Amazon policy. View a full list of our [policies](#) for more detail.

Seller Forums: [ask other Sellers and Amazon](#)

Account Health Rating

1000

This rating reflects your adherence to Amazon's selling policies. [Learn more.](#)

Add Filters
Applied Filters: Received Intellectual Property Complaints (3) X
Sort by

Date: Most recent - oldest

Reason	Date	What was impacted? <small>ASIN</small>	Action Taken	Account Health Rating Impact	Next Steps
Patent Infringement	Jul 5, 2023	Black Silicone Spoon Rest for Stove Top with Drip Pad (Two Pack) - Heat-Resistant, BPA-Free Utensil Rest & Spoon Holder for Kitchen Counter-Grill Utensil Holder for Spatulas, Tongs, Ladles <small>ASIN: B0874SHJFX</small>	Listing removed	High	<div style="background-color: #0070c0; color: white; padding: 5px; width: 60px; margin: 0 auto;">Submit appeal</div> <small>Status: Your submission is required.</small>
Patent Infringement	Jul 5, 2023	Red Silicone Spoon Rest for Stove Top with Drip Pad (Two Pack) - Heat-Resistant, BPA-Free Utensil Rest & Spoon Holder for Kitchen Counter-Grill Utensil Holder for Spatulas, Tongs, Ladles <small>ASIN: B0874S11MY</small>	Listing removed	High	<div style="background-color: #0070c0; color: white; padding: 5px; width: 60px; margin: 0 auto;">Submit appeal</div> <small>Status: Your submission is required.</small>
Patent Infringement	Jul 5, 2023	Grey Silicone Spoon holder for Stove Top with Drip Pad (Two Pack) - Heat Resistant, BPA Free Utensil Rest & Spoon Rest for Kitchen Counter - Grill Utensil Holder for Spatulas, Tongs, Ladles <small>ASIN: B0874S275K</small>	Listing removed	High	<div style="background-color: #0070c0; color: white; padding: 5px; width: 60px; margin: 0 auto;">Submit appeal</div> <small>Status: Your submission is required.</small>

Page 1 of 1 Go
< 1 >
25 per page

Help Program Policies English
Download the Amazon Seller mobile app