

**IN THE UNITED STATES DISTRICT COURT  
FOR THE EASTERN DISTRICT OF NEW YORK**

MARUT ENTERPRISES LLC and BRETT  
MARUT,

Plaintiffs,

v.

FOTO ELECTRIC SUPPLY CO., INC.,

Defendant.

CASE NO. 1:23-cv-5875

**COMPLAINT FOR PATENT  
INFRINGEMENT**

**JURY TRIAL DEMANDED**

Plaintiffs Marut Enterprises LLC (“Marut Enterprises”) and Brett Marut (“Mr. Marut”) (collectively “Plaintiffs”) through their undersigned counsel, bring this action against Defendant Foto Electric Supply Co., Inc. (“Foto” or “Defendant”). In support of the Complaint, Plaintiffs allege as follows:

**NATURE OF THE ACTION**

1. This a patent infringement action against Defendant for infringement of United States Patent No. 7,856,725 (“the ’725 Patent” or “the Asserted Patent”).
2. Defendant has intentionally infringed the ’725 Patent by manufacturing, making, using, marketing, offering for sale and/or selling infringing shaver products (“Foto Shavers”).

**THE PARTIES**

3. Plaintiff Marut Enterprises LLC is a California limited liability company having a principal place of business at 1855 West Katella Ave, Ste 365, Orange, California 92867.
4. Plaintiff Brett Marut is an individual residing in Miami Beach, Florida.

5. On information and belief, Defendant Foto Electric Supply Co., Inc. is a New York corporation having a principal place of business at 1264 E 27th Street, Brooklyn, New York 11210.

### **JURISDICTION AND VENUE**

6. This Court has original subject matter jurisdiction over this action pursuant to 28 U.S.C. §§ 1331 and 1338(a).

7. This Court has personal jurisdiction over the Defendant because, on information and belief, it is organized and exists under the laws of the State of New York. On information and belief, Defendant was incorporated within the State of New York on June 2, 1980 and maintains a principal place of business at 1264 E 27th Street, Brooklyn, New York 11210.

8. In addition, on information and belief, Defendant has conducted and does conduct business within the State of New York. Defendant manufactures, markets, distributes, ships, imports, offers for sale, and/or sells Foto Shavers, directly or through intermediaries, in the State of New York and the Eastern District of New York. Defendant has committed acts of patent infringement within the State of New York and the Eastern District of New York.

9. Venue in this Judicial District is proper under 28 U.S.C. §§ 1391(b) and 1400(b) because Defendant is incorporated under the laws of the State of New York and maintains a principal place of business at 1264 E 27th Street, Brooklyn, New York 11210.

### **THE '725 PATENT**

10. United States Patent No. 7,856,725 is titled “RAZOR WITH ARTICULATED HANDLE EXTENSION” and was issued by the United States Patent and Trademark Office on December 28, 2010. A true and correct copy of the '725 Patent is attached hereto as **Exhibit A**.

11. Mr. Marut owns the '725 Patent. As the owner of the '725 Patent, Mr. Marut possesses the right to sue and to recover for infringement of the '725 Patent.

12. Marut Enterprises possesses the exclusive right to manufacture, market, and sell the invention of the '725 Patent. As the exclusive rightsholder to manufacture, market, and sell the invention of the '725 Patent, Marut Enterprises possesses the right to sue and to recover for infringement of the '725 Patent.

13. The '725 Patent discloses a razor design that includes a pivoting, extendable handle to assist the user in reaching areas of the body that cannot be reached with a normal sized razor.

14. The invention is an improvement over the prior art, offering a personal grooming product that is easier and more efficient to use than competing products.

15. Marut Enterprises manufactures and sells the invention of the '725 Patent through its website mangroomer.com, as well as through general e-commerce websites such as amazon.com. The Amazon webpage for one of Marut Enterprises' products is shown below.

The screenshot displays the Amazon product page for the MANGROOMER Do-It-Yourself Electric Back Hair Shaver (101-6). On the left, there is a main product image of the shaver, which is silver and black, with a pivoting handle. Below the main image are several smaller thumbnail images showing different views and features of the shaver. To the right of the image, the product title is 'MANGROOMER Do-It-Yourself Electric Back Hair Shaver (101-6)'. Below the title, it says 'Visit the MANGROOMER Store' and shows a 3.8-star rating with 6,108 ratings and 39 answered questions. The price is listed as \$39.99, which is a 20% discount from the list price of \$49.99. There is a 'FREE Returns' option. Below the price, there is a promotional message: 'Unlock a \$60 Amazon Gift Card upon approval for the Amazon Store Card. No annual fee. Get info'. A table of specifications follows: Brand: MANGROOMER; Recommended Uses For Product: Back Hair; Special Feature: Features: Adjustable Handle; Power Source: Battery Powered; Included Components: Charger. Below the table, there is an 'About this item' section with a list of bullet points: 'Shave off all your back hair effortlessly with the new mangroomer essential back shaver', 'Unique patented design enables men of all sizes and shapes to easily reach all areas of your back from different angles with ease', 'Sleek, lightweight, compact design goes from its discreet stored position to fully functional easily in a matter of seconds', 'Extra-wide blade enables extremely close and smooth results without the potential of ingrown hairs that manual back razors commonly cause. Fully extendable and adjustable handle locks into place at various lengths to reach even the most difficult middle and lower portions of the back', and 'Operates on just 2 AA batteries'. Below the 'About this item' section, there is an 'Additional Details' section with a 'Small Business' logo and text: 'This product is from a small business brand. Support small. Learn more'. On the right side of the page, there is a Prime banner with the text: 'Enjoy fast, FREE delivery, exclusive deals and award-winning movies & TV shows with Prime. Try Prime and start saving today with Fast, FREE Delivery'. Below the banner, there are 'Delivery' and 'Pickup' options. The price is shown as \$39.99 (\$39.99 / Count) with a 'FREE Returns' option. Below the price, it says 'FREE delivery Wednesday, August 2' and 'Or fastest delivery Sunday, July 30. Order within 3 hrs 23 mins'. There is a 'Select delivery location' option. Below that, there is a 'Qty: 1' dropdown menu. At the bottom of the right side, there are 'Add to Cart' and 'Buy Now' buttons. Below the buttons, there is a 'Payment' section with 'Secure transaction' and 'Ships from Amazon'. Below that, it says 'Sold by MANGROOMER' and 'Returns Eligible for Return, Refund or Replacement within 30 days of receipt'. At the very bottom of the right side, there is an 'Add a Protection Plan:' option.

16. Because of the benefits offered by the claims of the '725 Patent, Plaintiffs have sold hundreds of thousands of shavers covered by the claimed invention of the '725 Patent.

**THE ACCUSED PRODUCTS**

17. Because of the benefits offered by the claims of the '725 Patent, Defendant copied every aspect of Mr. Marut’s invention, manufacturing and selling Foto Shavers that infringe the '725 Patent.

18. Defendant sells Foto Shavers at least through amazon.com under the names “Groom Essentials” and “CHARGEWORX.” The Amazon webpage for two models of Foto Shavers is shown below. The first image shows a “battery operated” model, the second image shows a “rechargeable” model.

The screenshot displays an Amazon product listing for a cordless back shaver. On the left, a man is shown from the back, using the shaver on his upper back. The product title is "Groom Essentials Cordless Back Shavers for Men | Battery Operated Hair Trimmer for Men w/Extendable & Foldable Arm for Hard-to-Reach Areas | Back Shaver, Body Trimmer for Men | Electric Razor for Men". The price is listed as \$19.50, with a note that it is a "FREE Returns" item. A promotional offer states: "Get \$60 off instantly: Pay \$0.00 \$19.50 upon approval for the Amazon Store Card. No annual fee." The product is categorized as "Style: Battery Operated". Two options are shown: one for \$19.50 and another for \$25.99. The brand is "CHARGEWORX". Special features include "Cordless", "Battery Powered", and "Cleaning Brush". The item weight is "0.4 Pounds". Under "About this item", two bullet points describe the ergonomic handle and the battery operation. The right side of the page shows the Prime logo, shipping information ("FREE delivery Wednesday, August 2"), and purchase buttons ("Add to Cart" and "Buy Now").

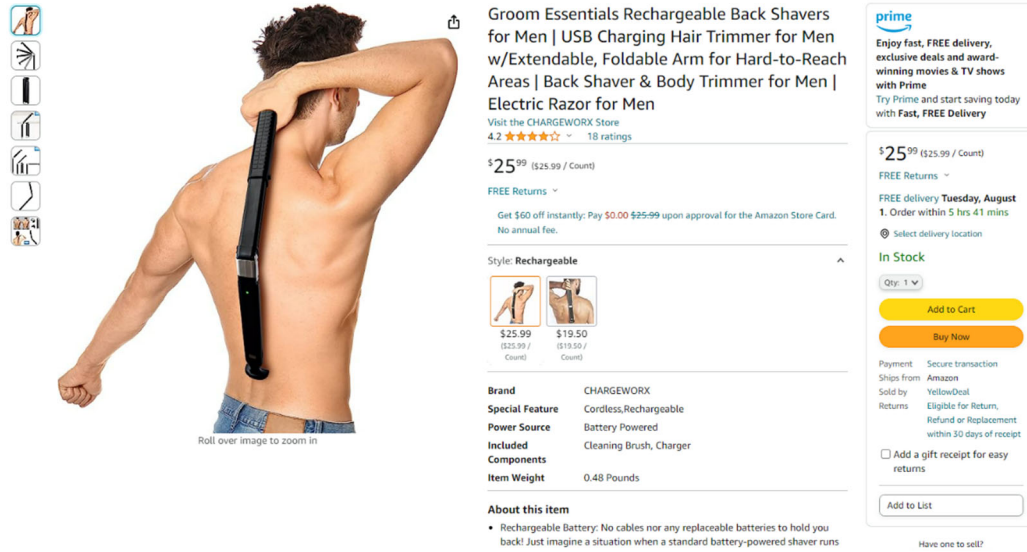

19. The Amazon webpage for each model identifies the manufacturer as “Foto Electric Supply Co.” The first image below shows the “Product details” for the “battery operated” model, the second image shows the “product details” for the “rechargeable” model.

**Product details**

**Product Dimensions :** 2.17 x 2.05 x 9.33 inches; 6.4 Ounces  
**Item model number :** GEMS107  
**Batteries :** 2 AA batteries required.  
**Date First Available :** March 23, 2023  
**Manufacturer :** Foto Electric Supply Co  
**ASIN :** B0BZFPPC7F  
**Country of Origin :** China

**Product details**

**Product Dimensions :** 2.17 x 2.05 x 9.33 inches; 7.68 Ounces  
**Item model number :** GEMS108  
**Batteries :** 1 Lithium Ion batteries required. (included)  
**Date First Available :** March 23, 2023  
**Manufacturer :** Foto Electric Supply Co  
**ASIN :** B0BZF8Y337  
**Country of Origin :** China

20. On information and belief, Defendant has been manufacturing and/or selling Foto Shavers since at least March 23, 2023.

21. The infringement analysis below applies equally to both Foto Shaver models.

**COUNT 1: Infringement of U.S. Patent No. 7,856,725**

22. Plaintiffs incorporate by reference the foregoing paragraphs of this Complaint as if fully set forth herein.

23. On information and belief, Defendant, alone or by directing and controlling others, manufactured, used, marketed, distributed, imported, shipped, offered for sale, and/or sold and continues to sell in this district and elsewhere in the United States, Foto Shavers which infringe at least claim 1 of the '725 Patent, literally or under the doctrine of equivalents, as identified below in violation of 35 U.S.C. § 271.

24. Claim 1 recites: “A razor assembly, comprising.” The Foto Shavers are razor assemblies, as shown below with packaging:



25. Claim 1 further recites: “a shaving head.” The Foto Shavers have a shaving head:

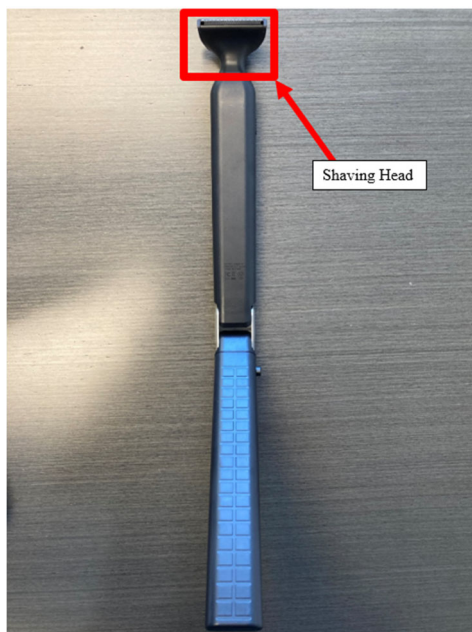

26. Claim 1 further recites: “a handle having.” The Foto Shavers have a handle:

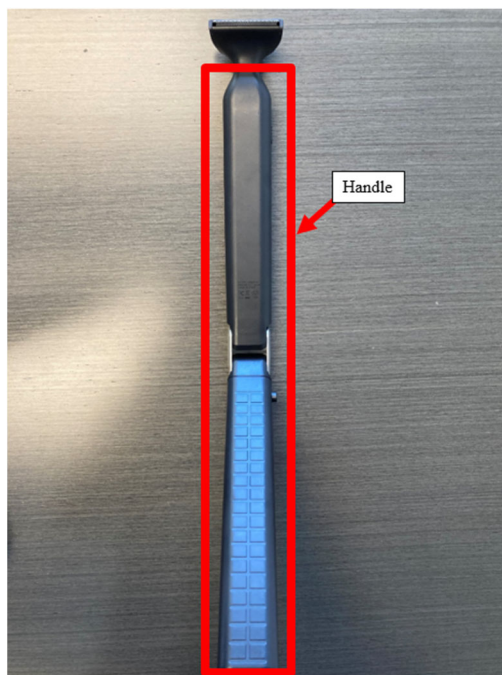

27. Claim 1 further recites: “a connector having a first engageable surface, and two parallel side plates.” The Foto Shavers have these claim elements, highlighted below:



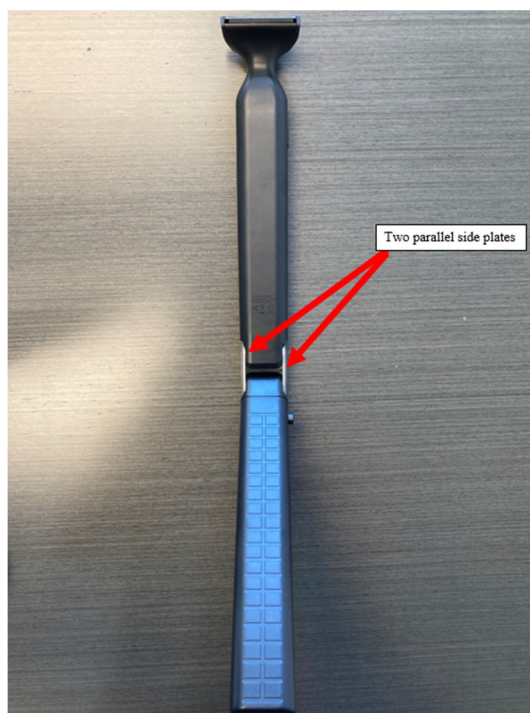
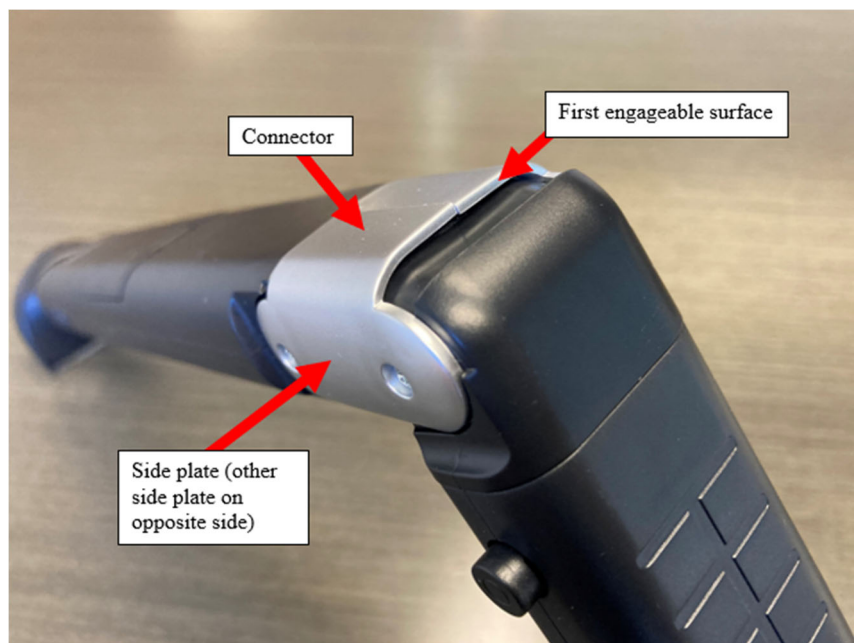

28. Claim 1 further recites: “a first handle section connected to the shaving head.”

The Foto Shavers have a first handle section connected to the shaving head:



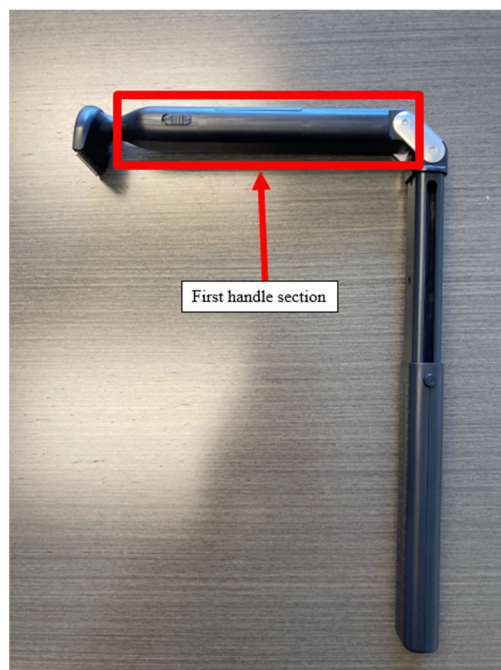

29. Claim 1 further recites: “a second handle section pivotably coupled to the first handle section by the connector, the second handle section having.” The Foto Shavers have a second handle section pivotably coupled to the first handle section by the connector:

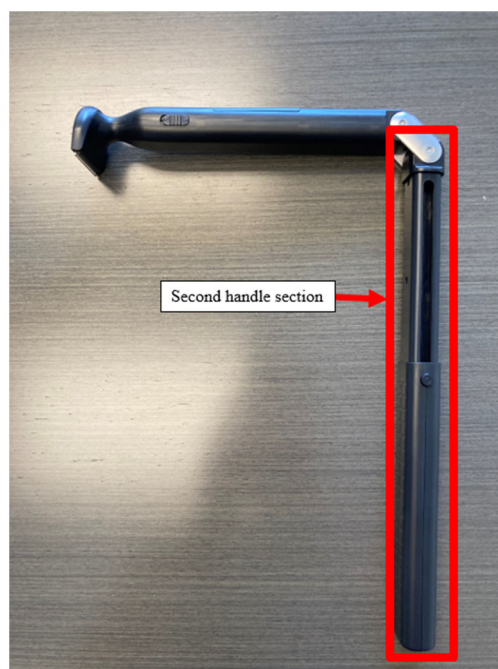

30. Claim 1 further recites: “a second engageable surface.” The second handle section has a second engageable surface:

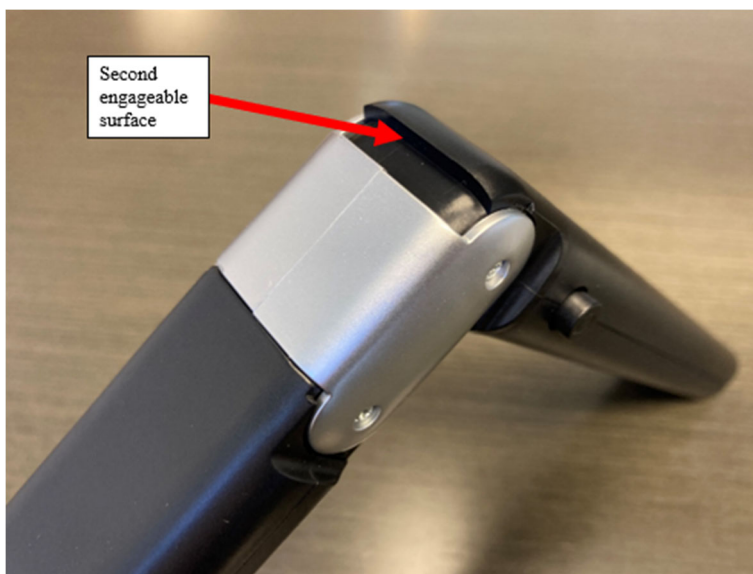

31. Claim 1 further recites: “a first portion and a second portion, with the first portion being slidable with respect to the second portion to adjust the length of the second handle section, and.” The second handle section has a first portion and a second portion as described in the claim:

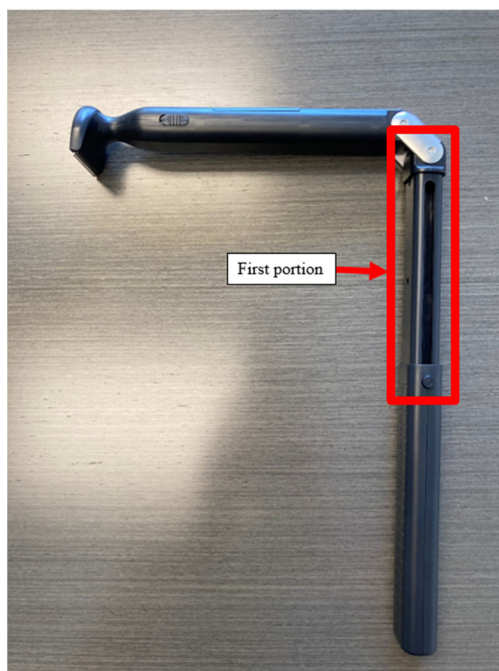

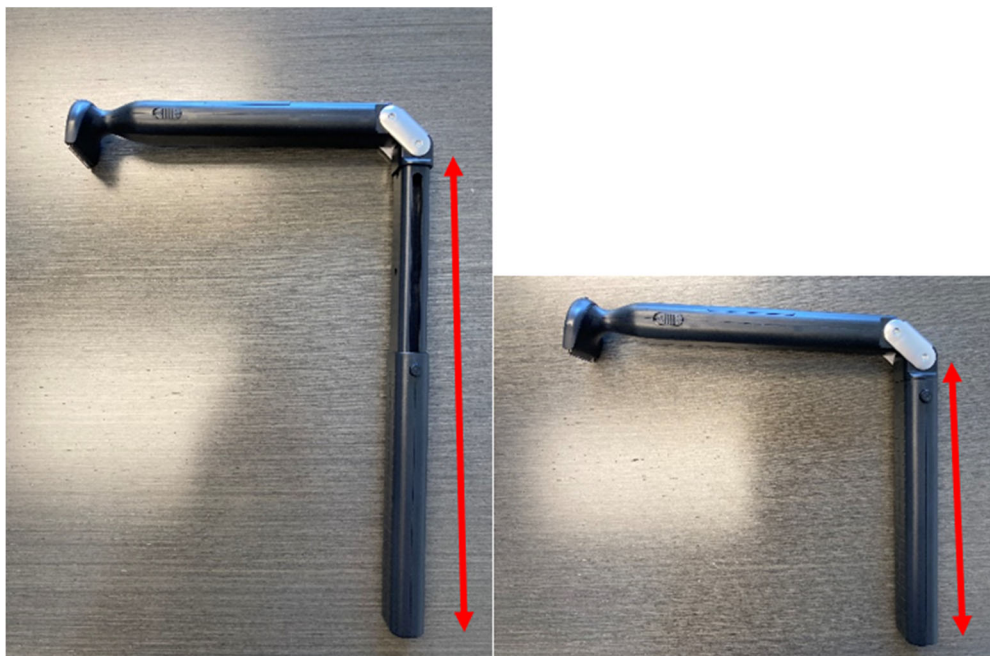

32. Claim 1 further recites: “a detent assembly for locking the first portion at a fixed location along the second portion, the detent assembly including a button resting on a plate, with an elastic member coupled between and contacting the plate and the first portion and biasing the button through the first portion, the button being movable longitudinally along the first portion.” The Foto Shavers have these claim elements as shown below:

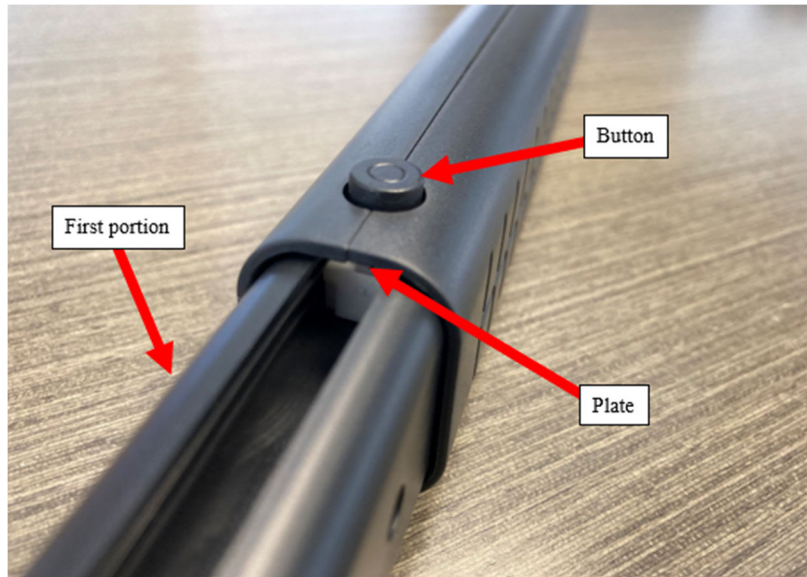
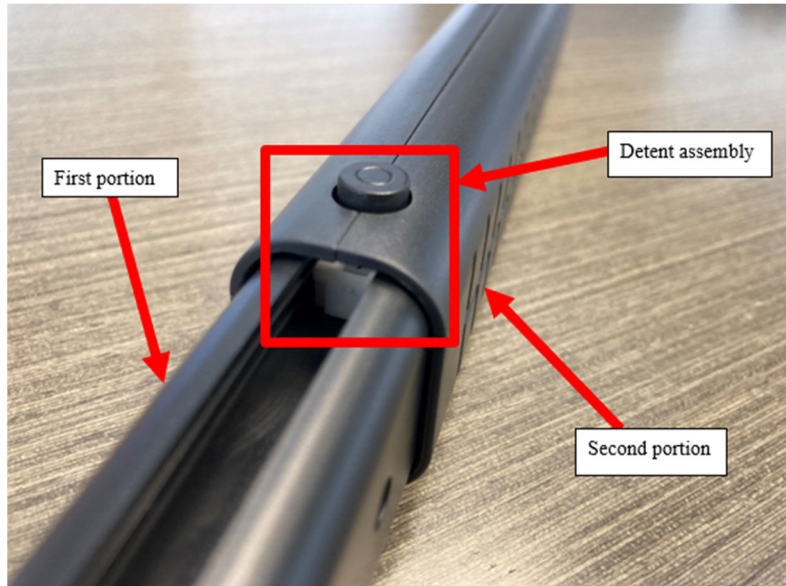



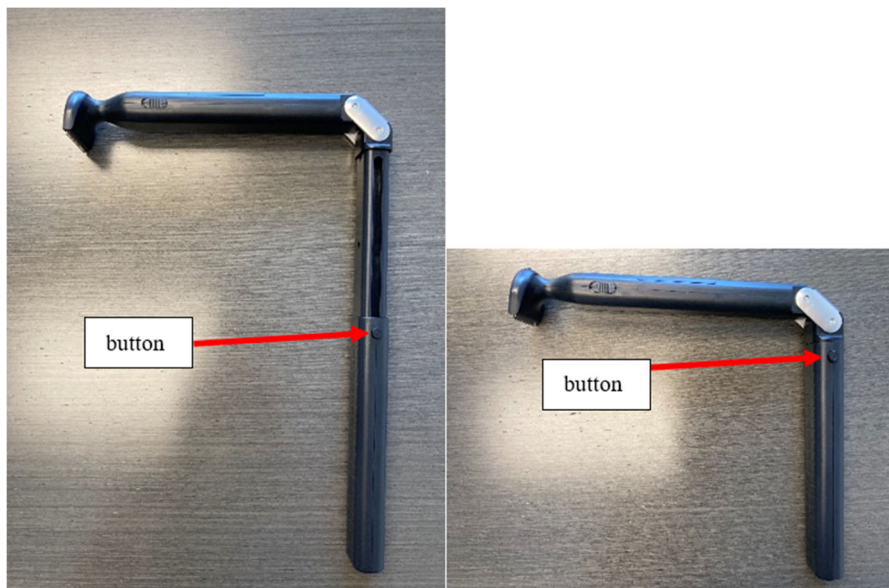

33. Claim 1 further recites: “wherein the second handle section is pivoted in a first direction to a first retracted position side-by-side the first handle section.” The Foto Shavers have these claim elements as shown below:

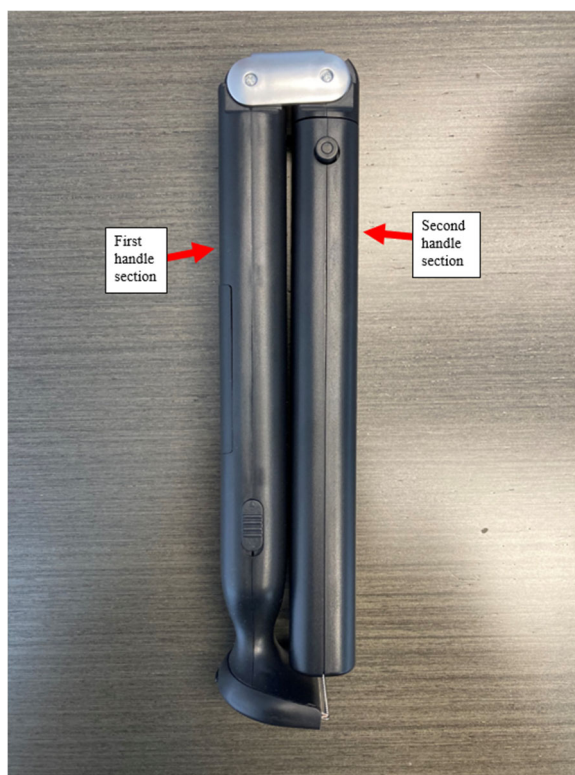



34. Claim 1 further recites: “and pivoted in a second direction to a second extended position with respect to the first handle section, wherein the first and second engageable surfaces engage each other to limit the pivoting of the handle sections with respect to each other at the second extended position to an angle of no more than 135 degrees; and.” The Foto Shavers have these claim elements as shown below:

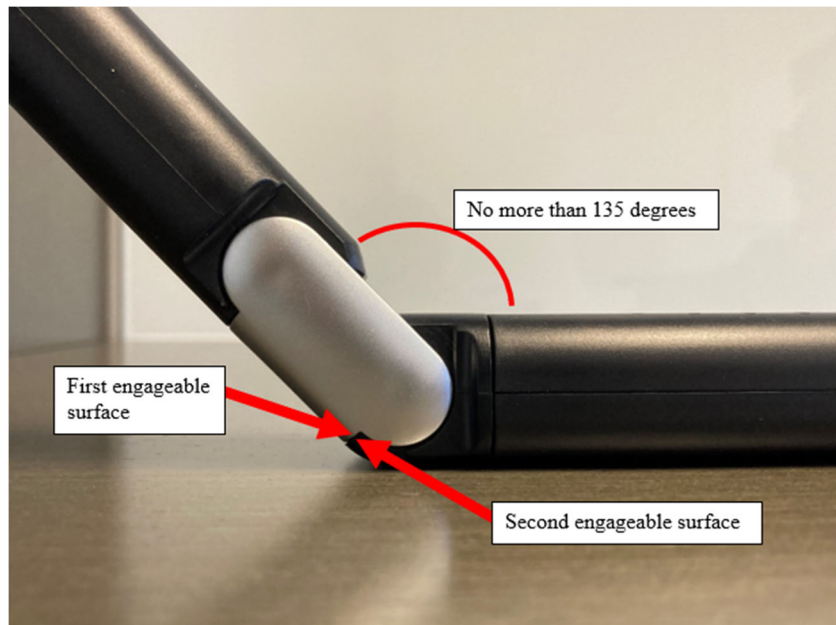





35. Claim 1 further recites: “wherein each of the first and second handle sections has an outer surface, and two recessed surfaces adjacent the location where each handle section is pivotably coupled to the side plates, and the recessed surfaces accept the side plates in a manner to provide two flush parallel surfaces extending across the side plates to the outer surfaces of the first and second handle sections.” The Foto Shavers have these claim elements as shown below:

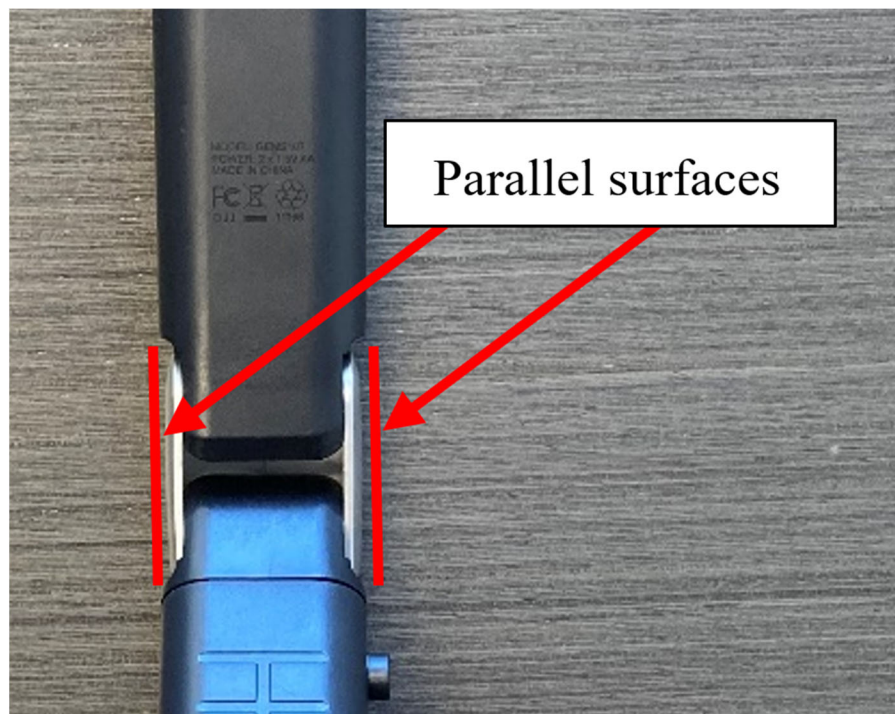
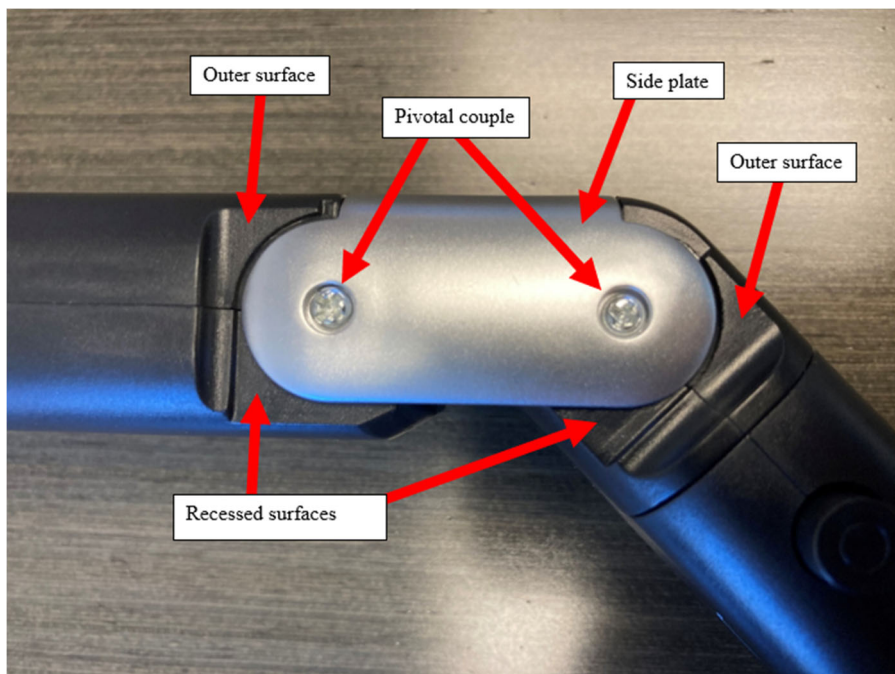

36. On information and belief, given the striking similarity between the Foto Shavers and the figures in the '725 Patent, Defendant knowingly or with reckless disregard willfully infringed the '725 Patent at least as of the time they designed the Foto Shavers.

37. To illustrate the similarity between the figures in the '725 Patent and the Foto Shavers, Fig. 1a is shown below left, a Foto Shaver is shown below right.

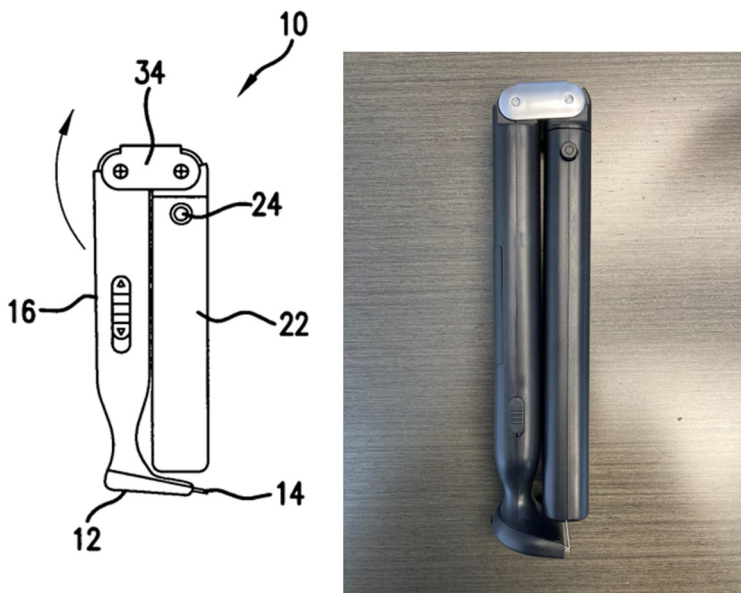

38. Fig. 1b is below left, a Foto Shaver is below right.

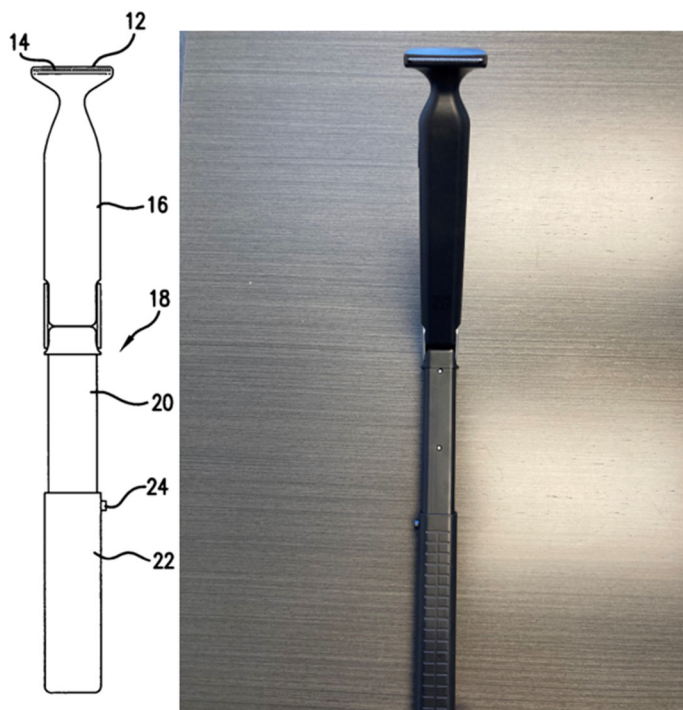

39. Fig. 1c is below left, a Foto Shaver is below right.

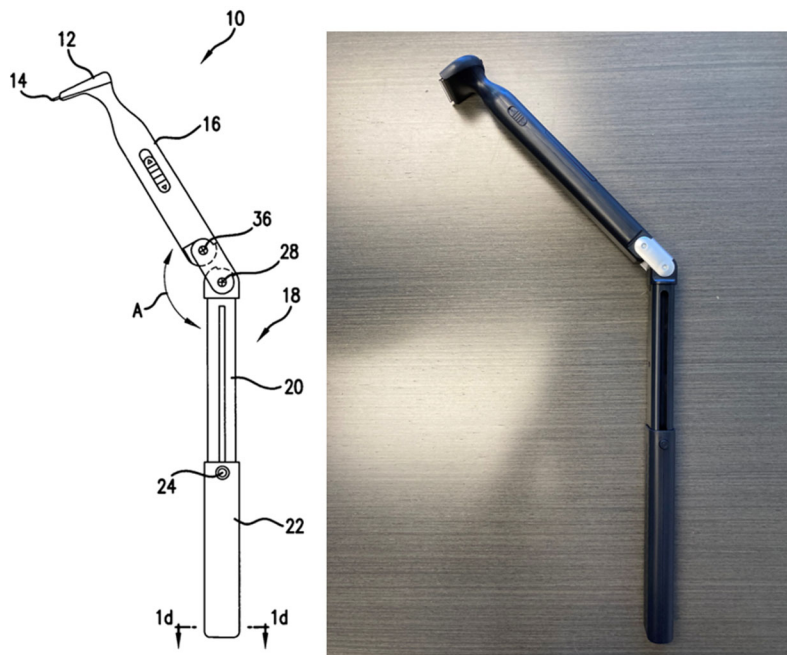

40. Fig. 1e is below left, a Foto Shaver is below right.

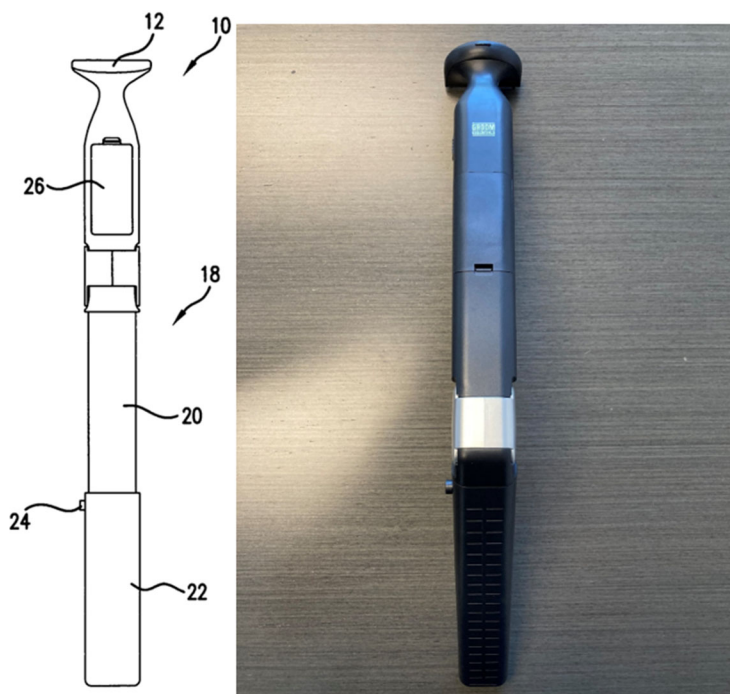

41. In addition, Defendant had actual knowledge of the '725 Patent at least as of May 26, 2023, when Plaintiffs, through counsel, sent a letter to Defendant's counsel informing them that their Foto Shavers infringed the '725 Patent.

42. Due to Defendant having actual notice of infringement of the '725 Patent and continuing to infringe despite an objectively high likelihood that its actions constitute infringement of Plaintiffs' valid patent rights, Plaintiffs seek enhanced damages pursuant to 35 U.S.C. § 284.

**PRAYER FOR RELIEF**

1. Wherefore, Plaintiffs demand judgment against Defendant as follows:
  - a. That it has jurisdiction of the parties and of the subject matter of this action;
  - b. That the '725 Patent is valid and owned by Mr. Marut;
  - c. That Defendant has infringed the '725 Patent by manufacturing, using, distributing, importing, shipping, using, marketing, offering for sale and/or selling the Foto Shavers;
  - d. That Defendant's infringement is willful;
  - e. That Defendant and all affiliates, subsidiaries, officers, employees, agents, representatives, licensees, successors, assigns, and all those acting in concert with, or on behalf of Defendant, be enjoined from further infringing the '725 Patent.
  - f. That Defendant be required by mandatory injunction to deliver up to Plaintiffs for destruction any and all Foto Shavers in Defendant's possession, custody, or control, as well as any promotional literature and packaging which display the Foto Shavers.
  - g. That Plaintiffs be awarded damages covered by the acts of patent infringement of Defendant in an amount not less than a reasonable royalty pursuant to 35 U.S.C. § 284 or in an amount equal to Defendant's profits

pursuant to 35 U.S.C. § 289, whichever is greater and that such damages be trebled in accordance with the provisions of 35 U.S.C. § 284;

- h. That Defendant pay Plaintiffs prejudgment interest on all infringement damages;
- i. That Plaintiffs recover their costs in this action, including attorneys' fees; and
- j. That Plaintiffs have such other or further relief as the Court may deem just and proper.

**JURY DEMAND**

Plaintiffs hereby request a trial by jury pursuant to Rule 38 of the Federal Rules of Civil Procedure.

Dated: August 2, 2023

Respectfully submitted,

/s/ Sarah S. Brooks

Sarah S. Brooks (NY Bar # 4379400)  
Venable LLP  
2049 Century Park East, Suite 2300  
Los Angeles, CA 90067  
Tel: (310) 229-9900  
Fax: (310) 229-9901  
ssbrooks@venable.com

*Attorney for Plaintiffs*