

**UNITED STATES DISTRICT COURT
EASTERN DISTRICT OF TEXAS
MARSHALL DIVISION**

<p>LONGITUDE LICENSING LIMITED,</p> <p style="text-align: center;">Plaintiff,</p> <p style="text-align: center;">v.</p> <p>BOE TECHNOLOGY GROUP CO., LTD.,</p> <p style="text-align: center;">Defendant.</p>	<p>Civil Action No. <u>2:23-cv-00515</u></p> <p style="text-align: center;">JURY TRIAL DEMANDED</p>
--	--

COMPLAINT FOR PATENT INFRINGEMENT

Plaintiff Longitude Licensing Limited (“Plaintiff” or “Longitude”) alleges patent infringement against Defendant BOE Technology Group Co., Ltd. (“BOE” or “Defendant”):

INTRODUCTION

1. This is an action for patent infringement under the Patent Laws of the United States, 35 U.S.C. § 1 *et seq.* Longitude alleges that BOE has infringed and continues to infringe, directly and indirectly, six patents: U.S. Patent Nos. 7,502,079 (“the ’079 patent”), 7,705,948 (“the ’948 patent”), 8,223,093 (“the ’093 patent”), 9,184,157 (“the ’157 patent”), 9,557,606 (“the ’606 patent”), and 10,181,462 (“the ’462 patent”) (collectively, the “Longitude Patents”). *See* Exs. 1-6, attached.

2. The Longitude Patents are directed to foundational liquid crystal display (“LCD”) technologies used in modern LCD devices, panels, and/or modules, covering

innovations relating to, for example, pixel layouts, electrode structures, panel seals and terminals, and driving circuitry.

3. BOE has infringed and continues to infringe the Longitude Patents, directly and indirectly, by (1) making, using, offering to sell, selling, and/or importing into the United States LCD panels and/or modules that include the claimed innovations of the Longitude Patents; (2) inducing third parties (e.g., BOE customers and end-users) to make, use, offer to sell, sell, and/or import into the United States BOE products and/or components (e.g., BOE LCD panels) that include the claimed innovations of the Longitude Patents, with knowledge of the Longitude Patents and with specific intent to cause the third parties' infringement; and (3) contributing to third parties' (e.g., BOE customers and end-users) direct infringement of the Longitude Patents by offering to sell, selling, and/or importing into the United States components of patented devices, which constitute a material part of the claimed inventions, with knowledge of the Longitude Patents and of the third parties' infringement.

4. Longitude seeks damages and other relief for BOE's infringement of the Longitude Patents.

THE PARTIES

5. Plaintiff Longitude Licensing Limited is a private limited company registered in the Republic of Ireland, having a principal place of business at Plaza 255, Suite 2A, Blanchardstown Corporate Park 2, Dublin 15, D15 YH6H, Ireland.

6. On information and belief, Defendant BOE is a company organized and existing under the laws of China, having a principal place of business at No. 12,

Xihuazhong Road, BDA, Beijing, 100176, China.

JURISDICTION AND VENUE

7. This is an action for patent infringement under the Patent Laws of the United States, 35 U.S.C. § 1 *et seq.*

8. This Court has subject matter jurisdiction pursuant to 28 U.S.C. §§ 1331 and 1338(a).

9. This Court may exercise general and specific personal jurisdiction over BOE consistent with the requirements of the Due Process Clause of the United States Constitution and the Texas Long Arm Statute. On information and belief, BOE has intentionally manufactured and/or distributed LCD panels and/or modules that infringe the Longitude Patents, and/or caused its subsidiaries, affiliates, or intermediaries to manufacture and/or distribute infringing LCD panels and/or modules, through established distribution channels, intending that those products be sold in the United States, the State of Texas, and this District. BOE holds itself and its subsidiaries out as a single global entity serving the United States. For example, according to BOE's website, its "subsidiaries span 20 countries and regions, including the United States," and "[i]ts service network covers major regions in Europe, the Americas, Asia, Africa and beyond." <https://www.boe.com/en/about/index> (last accessed Nov. 8, 2023).

10. Further, BOE has (itself and/or through subsidiaries, affiliates, or intermediaries) committed acts of patent infringement in the United States, the State of Texas, and this District, including by making, using, offering to sell, and/or selling infringing BOE LCD panels and/or modules in the United States, the State of Texas, and

this District and/or inducing others to commit acts of patent infringement and/or contributing to the direct infringement of others in the United States, the State of Texas, and this District.

11. On information and belief, BOE knows or should reasonably expect that the Accused Instrumentalities, described *infra*, are incorporated in finished products sold in the United States, including in Texas (the U.S. state with the second-highest population) and this District. BOE knows that Accused Instrumentalities will be incorporated into finished consumer products, such as smartphones, tablet PCs, laptops, monitors, and TVs. On information and belief, BOE knows or should reasonably expect that finished consumer products, such as HP monitors and other consumer electronic devices identified and described *infra*, incorporating Accused Instrumentalities are sold in numerous retail locations throughout the United States, including in Texas and in this District. On information and belief, BOE knows or should reasonably expect that finished consumer products incorporating Accused Instrumentalities are sold through websites controlled by U.S. companies, such as HP, and accessible by U.S. consumers, including in Texas and in this District.

12. Accordingly, BOE has established minimum contacts within the forum and purposefully availed itself of the benefits of Texas, and the exercise of personal jurisdiction over BOE would not offend traditional notions of fair play and substantial justice. In addition, or in the alternative, this Court has personal jurisdiction over BOE pursuant to Federal Rule of Civil Procedure 4(k)(2).

13. Venue is proper in this District pursuant to 28 U.S.C. § 1391(c)(3) because

BOE does not reside in the United States and thus may be sued in any judicial district in the United States.

FACTUAL BACKGROUND

I. The Longitude Patents

14. Longitude is a privately owned intellectual property management company. Among other holdings, Longitude manages and licenses a portfolio of more than 1,000 active patents worldwide directed to display technologies. Longitude is the exclusive worldwide licensee of the Longitude Patents with exclusive rights to sublicense, enforce, and obtain damages, including past damages, for infringement of the Longitude Patents.

15. The '079 patent, entitled "Electro-Optical Device and Electronic Apparatus," duly and legally issued on March 10, 2009, from a patent application filed December 1, 2005, with Masao Murade as the sole named inventor. The '079 patent claims priority to Foreign (JP) Patent Application Nos. 2002-000713, filed on January 7, 2002, and 2002-363864, filed December 16, 2002. The claimed invention relates to a particular LCD layout providing two-fold benefits, including data lines comprising a "broader" region to provide light-shielding benefits over a wider channel region and a "narrower" region to allow for overall panel miniaturization.

16. The '948 patent, entitled "Liquid Crystal Display Device," duly and legally issued on April 27, 2010, from a patent application filed October 12, 2007, with Yasuo Segawa, Masaaki Aota, and Shinji Ichikawa as the named inventors. The '948 patent claims priority to Foreign (JP) Patent Application No. 2006-280583, filed on October 13, 2006. The claimed inventions relate to geometries for slits in liquid crystal pixel

structures. These geometries provide benefits including reducing disclination at the slit ends, which improves light transmission and overall image quality. The claimed geometry also improves stability in the patterning process, increasing yield during manufacturing.

17. The '093 patent, entitled "Electrooptic Device, Electronic Apparatus, and Projection Display" duly and legally issued on July 17, 2012, from a patent application filed August 28, 2009, with Tomoki Yokota as the named inventor. The '093 patent claims priority to Foreign (JP) Patent Application No. 2008-258122, filed on October 3, 2008. The claimed inventions relate to a novel way to configure the position and orientation of pixel electrodes relative to the transistors that control each pixel, which enables pixel size to be reduced without reducing the size of the transistor for each pixel. The claimed inventions provide benefits such as enabling the production of displays with greater pixel density and therefore resolution without the cost and complexity of producing smaller transistors.

18. The '157 patent, entitled "Semiconductor Device, Display Device, and Electronic Apparatus," duly and legally issued on November 10, 2015, from a patent application filed May 6, 2009, with Yutaka Kobashi as the sole named inventor. The '157 patent is a continuation of U.S. Application No. 11/101,450, filed on April 8, 2005, and claims priority to Foreign (JP) Patent Application No. 2004-198040, filed on July 5, 2004. The claimed inventions relate to placing protective circuits connected to power lines and the driving circuit on both sides of a driving circuit built into the display substrate of a display panel. The protective circuits provide benefits such as protecting

the driving circuitry from electrostatic shock damage that can enter the display substrate circuitry via signal and power lines.

19. The '606 patent, entitled "Liquid Crystal Display Device Having Rectangular Close-shape Seal Members," duly and legally issued on January 31, 2017, from a patent application filed December 16, 2014, with Yoichi Momose and Satoshi Hasegawa as the named inventors. The '606 patent claims priority to Foreign (JP) Patent Application No. 2004-375697, filed on December 27, 2004. The claimed inventions relate to an LCD panel with a continuous seal between substrates and arranging conductive portions away from electrical elements crossing the seal. The "one-drop" fill manufacturing process provided by the inventions provides benefits such as improving speed and reliability compared to prior manufacturing methods.

20. The '462 patent, entitled "Semiconductor Device, Display Device, and Electronic Apparatus," was duly and legally issued on January 15, 2019, from a patent application filed December 9, 2014, with Yutaka Kobashi as the sole named inventor. The '462 patent claims priority to Foreign (JP) Patent Application No. 2004-198040, filed on July 5, 2004. The claimed inventions relate to placing protective circuits connected to power and signal lines on both sides of a driving circuit built into the display substrate of an LCD panel. The two sets of protective circuits provide benefits such as protecting the driving circuitry from electrostatic shock damage that can enter the display substrate circuitry via signal and power lines.

21. Each of the Longitude Patents is valid and enforceable.

22. BOE is not authorized to practice the Longitude Patents.

23. The claimed inventions of the Longitude Patents enable BOE and its customers to sell LCD panels and/or modules with improved consumer-facing benefits, including improved image quality and brightness, and to realize improvements in manufacturing yields and costs.

II. The Inventors

24. The Longitude Patents describe and claim inventions developed by Seiko Epson Corporation (“Epson”). Epson is a Japanese electronics company that is a pioneer in the development of LCD technologies and a recognized innovator in the semiconductor and electronics components and devices spaces. The Longitude Patents cover foundational LCD innovations that Epson developed.

III. BOE

25. BOE is a Chinese multinational corporation that designs, manufactures, and sells electronic components. Headquartered in Beijing, BOE operates manufacturing facilities in at least 10 cities across China. According to its annual reports, BOE comprises five core operating divisions: (1) Display Devices, (2) IoT Innovation, (3) Sensors, (4) MLED, and (5) Smart Medical Engineering. BOE’s Display Devices business, through which it supplies customers with LCD and OLED display panels and modules for end-device applications including smartphones, tablet PCs, laptops, monitors, and automotive displays, accounted for more than 88 percent of BOE’s 2022 operating revenue and more than 92 percent of its 2021 operating revenue. BOE’s Display Devices business is a world leader in the global semiconductor display industry; for example, BOE’s 2022 annual report states that BOE’s semiconductor display products

rank first in the world in terms of shipment volume, and its LCD panels and modules rank first for the five mainstream applications (end devices) for LCD displays: smartphones, tablet PCs, laptops, monitors, and TVs.

26. On information and belief, BOE's Display Devices business provides LCD, OLED, and other display technology components, including display panels and modules, to third parties that then incorporate BOE display panels and modules into devices for end users. BOE's 2022 annual report refers to these third parties as its "brand customers."

27. On information and belief, BOE targets the United States for its sales of display panels and modules. For example, BOE's 2022 annual report states that approximately 20 percent of BOE's 2022 operating revenue was from BOE's "America" operating segment, which includes the United States. BOE's 2022 annual report also states that BOE ranked eleventh worldwide in terms of entities with the most U.S. patents granted, and that it has been among the global top 20 U.S. patent grantees for five consecutive years—BOE obtains U.S. patents to protect the U.S. market for its products. Furthermore, in a January 2017 press release, Li Xinguo, BOE Vice President and Director of BOE's Intellectual Property and Technology Management Center, commented on BOE's inclusion in the 2016 top 50 entities granted patent assignments by the USPTO, stating, "[i]n the past, BOE applied for patents mainly to protect our products. Now, we also seek to increase the market shares of our products. Patent grants will not only support our business but also drive development of our business." BOE Press Release, "BOE ranked 40th in the Top 50 USPTO Patent Assignees in 2016," Jan. 12, 2017, available at <https://www.boe.com/en/company/dynamic->

891ce385fc934f698f223a3072960c7e, last accessed Nov. 8, 2023.

28. On information and belief, BOE targets the U.S. market for its display panels and modules through its U.S.-based subsidiary, BOE Technology America, Inc. (“BOE America”). BOE’s global website states that BOE America currently has four offices in the United States, including an office in Texas. On information and belief, BOE established BOE America for the purpose of strategic brand customer development in the United States and North America and to provide services to BOE’s existing U.S. and North American brand customers, as described, e.g., at <https://wearable.su.domains/boe-2/> (last accessed Nov. 7, 2023).

29. BOE America is an extension of BOE. On information and belief, BOE America is controlled by BOE and under common ownership with BOE. According to BOE America’s corporate filings, its officers and directors are also high-level BOE (the Chinese parent) employees, indicating that BOE America exists for the purpose of serving BOE’s market in the United States for LCD panels and modules.

30. Thus, BOE—directly and/or through its subsidiaries, affiliates, or intermediaries—has imported, offered to sell, and sold, and continues to import, offer to sell, and sell infringing LCD panels and modules in the United States through established distribution channels. BOE intends to sell and does sell infringing products in the United States, the State of Texas, and this District.

IV. BOE’s Direct Infringement and Accused Instrumentalities

31. BOE has directly infringed and continues to directly infringe, pursuant to 35 U.S.C. § 271(a), one or more claims of each of the Longitude Patents (as further

specified in Counts I-VI) by making, using, offering to sell, selling within the United States, and/or importing into the United States, infringing LCD panels and modules (the “Accused Instrumentalities”).

32. The Accused Instrumentalities include LCD panels and modules incorporated in third-party devices, including smartphones, tablet PCs, laptops, monitors, TVs, and vehicle infotainment displays, as described here.

33. On information and belief, BOE imports, offers to sell, and sells Accused Instrumentalities in the United States and provides Accused Instrumentalities to third parties for sale in the United States as part of third-party devices, and BOE actively targets the U.S. market for sales of the Accused Instrumentalities. For example, on information and belief, BOE sells Accused Instrumentalities to customers for incorporation into electronic devices, and those sales occur in the United States. For example, BOE sells infringing LCD modules, a subset of the Accused Instrumentalities, to HP Inc. for incorporation into the HP 21kd monitor. HP Inc. is a U.S. company based in Palo Alto, California. On information and belief, BOE’s sales of these LCD modules to HP Inc.—a U.S. company—occur in the United States.

34. The above-described acts of direct infringement committed by BOE have caused and will continue to cause injury and damage to Longitude.

V. Longitude Provided Actual Notice of Infringement to BOE

35. Longitude provided actual notice, pursuant to 35 U.S.C. § 287(a), of the Longitude Patents and the alleged infringement over the course of its licensing negotiations with BOE.

36. Longitude's licensing negotiations with BOE began on or around January 2, 2020, when 138 East LCD Advancements Ltd. ("138 East"), the owner of the patent portfolio including the Longitude Patents, sent a letter (the "Initial Notice") to BOE. That letter identified Longitude as the entity that would represent 138 East during licensing negotiations with BOE. Longitude and its licensing representatives then participated in at least thirteen licensing meetings and exchanged with BOE numerous claim charts relating to the Longitude Patents and BOE's infringing products, between approximately September 2020 and July 2023.

37. Over the course of those licensing negotiations, Longitude provided actual notice to BOE of BOE's infringement of the '948, '606, '462, '079, and '093 patents and identified, in claim charts and in letters, exemplary infringing third-party devices incorporating Accused Instrumentalities, including LCD panels or modules used in TVs, monitors, and laptops.

38. Longitude provided to BOE actual notice of BOE's infringement of the '948 patent on or around January 2, 2020, as part of the Initial Notice.

39. Longitude provided to BOE actual notice of BOE's infringement of the '606 and '462 patents on or around April 8, 2021, in technical presentations to BOE during licensing negotiations.

40. Longitude provided to BOE actual notice of BOE's infringement of the '079 and '093 patents on or around September 28, 2023, in a letter provided to BOE identifying certain infringing BOE panels and modules in exemplary LG Electronics-branded consumer electronic devices.

41. Longitude provided to BOE actual notice of BOE's infringement of the '157 patent on or around November 6, 2023, in a letter sent to BOE explaining that certain Accused Instrumentalities infringe at least this additional patent.

42. Longitude proposed reasonable licensing terms to BOE in April 2023, as part of the parties' ongoing licensing negotiations, but BOE rejected Longitude's offer.

43. BOE continued to directly and indirectly infringe the Longitude Patents after Longitude provided actual notice of BOE's infringement of the Longitude Patents and identified exemplary third-party devices incorporating Accused Instrumentalities. BOE knew or should have known that its conduct infringed the Longitude Patents. BOE's continued and continuing direct and indirect infringement was and is deliberate and intentional. BOE has therefore willfully infringed each Longitude Patent at least since Longitude identified specific patents and infringement to BOE during the course of the parties' licensing negotiations: BOE has willfully infringed the '948 patent since at least January 2, 2020; the '606 and '462 patents since at least April 8, 2021; the '079 and '093 patents since at least September 28, 2023; and the '157 patent since November 6, 2023, or at least as of the filing of this complaint.

VI. BOE's Indirect Infringement

44. BOE has indirectly infringed and continues to indirectly infringe the Longitude Patents by inducing infringement by third parties under 35 U.S.C. § 271(b), including BOE's customers that incorporate Accused Instrumentalities into other electronic devices, and further including other importers, resellers, and end users in BOE's supply chain, in this District and elsewhere in the United States and the State of

Texas. For example, BOE has sold Accused Instrumentalities to LG Electronics, Inc., and HP, Inc., for incorporation into LG LCD TVs and monitors and HP LCD monitors, which on information and belief were available for sale through LG's and HP's authorized retailers, including Walmart and Best Buy, in this District, specifically, Walmart Marshall Supercenter, 1701 E End Blvd N., Marshall, TX 75670, and Best Buy, 422 W Loop 281, Ste. 100, Longview, TX 75605. On further information and belief, these same LG LCD TVs and monitors and HP LCD monitors have been available for sale through the websites of LG's and HP's authorized retailers or finished product suppliers, and those websites are accessible from the United States, the State of Texas, and this District.

45. BOE has induced, and continues to induce, others' direct infringement of the Longitude Patents by selling Accused Instrumentalities to third-party customers, including consumer electronics and vehicle manufacturers and/or sellers, who then directly infringe by making, using, offering to sell, and/or selling within the United States, and/or importing into the United States, the Accused Instrumentalities.

46. BOE knew and specifically intended that its customers and other importers, resellers, and end users in BOE's supply chain would sell infringing Accused Instrumentalities in the United States and/or cause Accused Instrumentalities to be sold in the United States—or deliberately avoided learning of the infringing circumstances so as to be willfully blind to the infringement that was induced. BOE specifically intended that its customers and other importers, resellers, and end users in BOE's supply chain would make, use, sell, or offer to sell Accused Instrumentalities in the United States, or import Accused Instrumentalities into the United States, as discussed in § III above.

47. BOE has induced others' direct infringement despite actual notice that the Accused Instrumentalities infringe the Longitude Patents, as described herein. BOE therefore has caused its third-party customers and other importers, resellers, and end users in BOE's supply chain to directly infringe the Longitude Patents with knowledge of the Longitude Patents and specific intent that the customers would directly infringe, or deliberately avoided learning of the infringing circumstances so as to be willfully blind to the infringement that was induced.

48. BOE also has contributed to and continues to contribute to direct infringement of the Longitude Patents by third parties, including its customers and other importers, resellers, and end users in BOE's supply chain, in violation of 35 U.S.C. § 271(c). BOE offers to sell, sells, and/or imports into the United States components of patented devices—specifically, certain Accused Instrumentalities. Those Accused Instrumentalities, including certain BOE LCD panels and modules, constitute a material part of the infringing third-party electronic devices into which they are incorporated. BOE knew that those Accused Instrumentalities were especially made for use in infringing the Longitude Patents—specifically, the '606 and '462 patents—at least after receiving actual notice of those patents. The Accused Instrumentalities that are incorporated into these third-party electronic devices have no substantial non-infringing use outside of those devices.

49. BOE specifically intends to cause the acts constituting direct infringement because it derives significant revenue by selling Accused Instrumentalities to third parties who directly infringe, and whose other importers, resellers, and end users directly

infringe, one or more claims of the Longitude Patents. On information and belief, BOE's Display Devices business's sales of LCD and OLED display panels and modules to third-party brand customers in the Americas accounted for approximately 20 percent of BOE's 2022 operating revenue, as discussed above in § III. On information and belief, a significant portion of BOE's Americas operating revenue is generated from sales of Accused Instrumentalities to BOE's brand customers in the United States for inclusion in third-party devices, for example, smartphones, tablet PCs, laptops, monitors, and automotive displays sold in the United States. And as discussed in § III, BOE specifically targets the United States market as a destination for sales of Accused Instrumentalities, actively seeks to develop strategic brand customer relationships with third parties that sell devices incorporating Accused Instrumentalities to end-users in the United States, and provides services to its existing brand costumers in the United States.

50. The above-described acts of indirect infringement committed by BOE have caused and will continue to cause injury and damage to Longitude.

COUNT I: INFRINGEMENT OF U.S. PATENT NO. 7,502,079

51. Pursuant to 35 U.S.C. § 282, the '079 patent is presumed valid.

52. BOE has directly infringed and continues to directly infringe one or more claims of the '079 patent, in violation of 35 U.S.C. § 271(a).

53. The Accused Instrumentalities directly infringe at least claim 2 of the '079 patent.

54. Paragraphs 56-62 describe the manner in which the Accused Instrumentalities infringe claim 2 of the '079 patent, by way of the exemplary BOE panel

in the LG 27-inch 27UK600 monitor. Longitude’s allegations of infringement are not limited to claim 2 or the exemplary product, and additional infringement will be identified and disclosed through discovery and in infringement contentions.

55. The panel in the LG 27-inch 27UK600 monitor is a BOE panel, as indicated by the “BOE” logo on the panel casing and the printed circuit board:

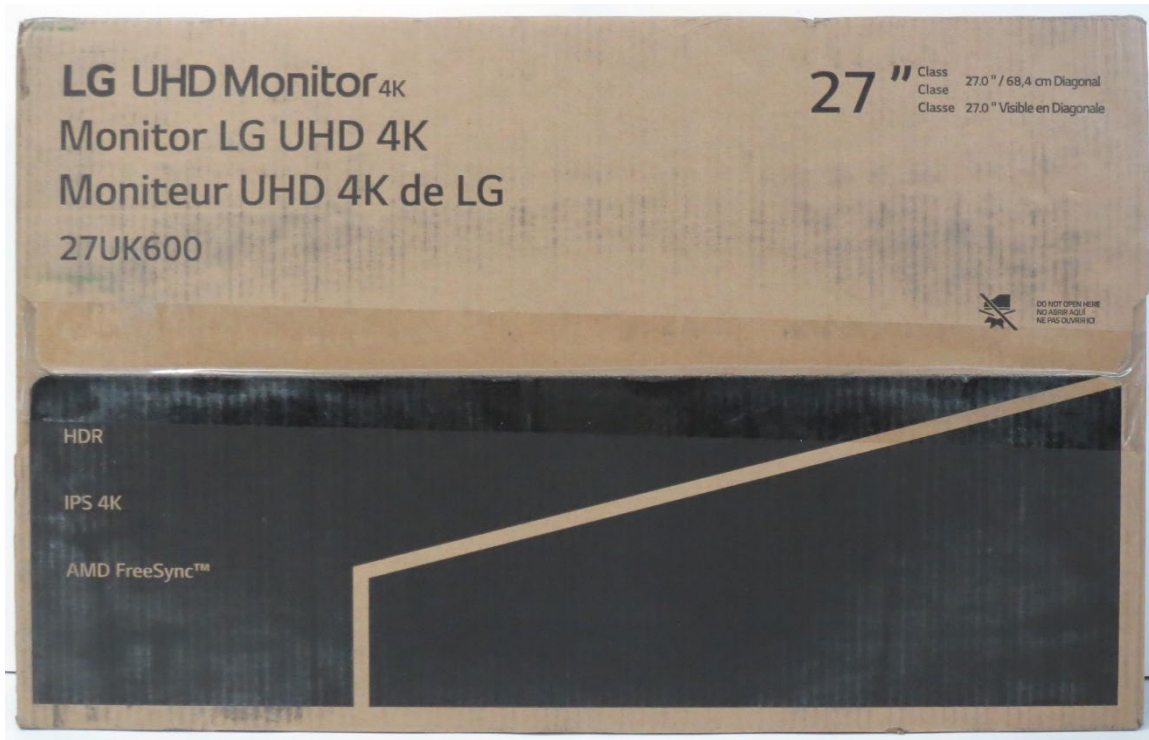



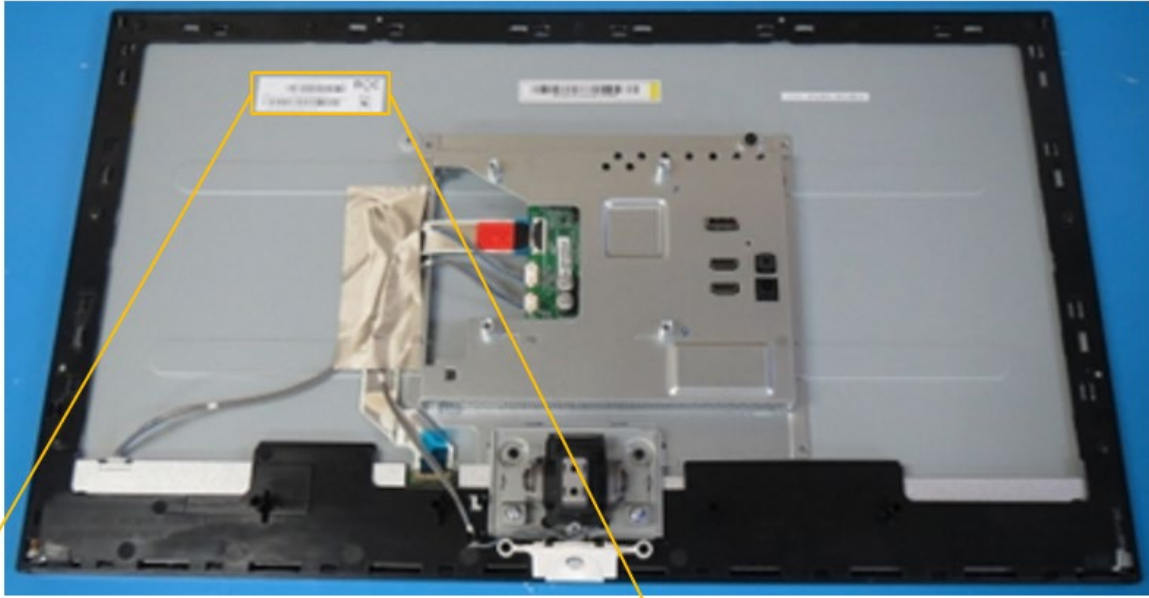

MV270QUM-N20 B5 BOE
1901 MLAA1915940004837N
BBVDMN20CCB51B5E91700AT
eCO
RoHS Compliant
CNS
MADE IN CHINA

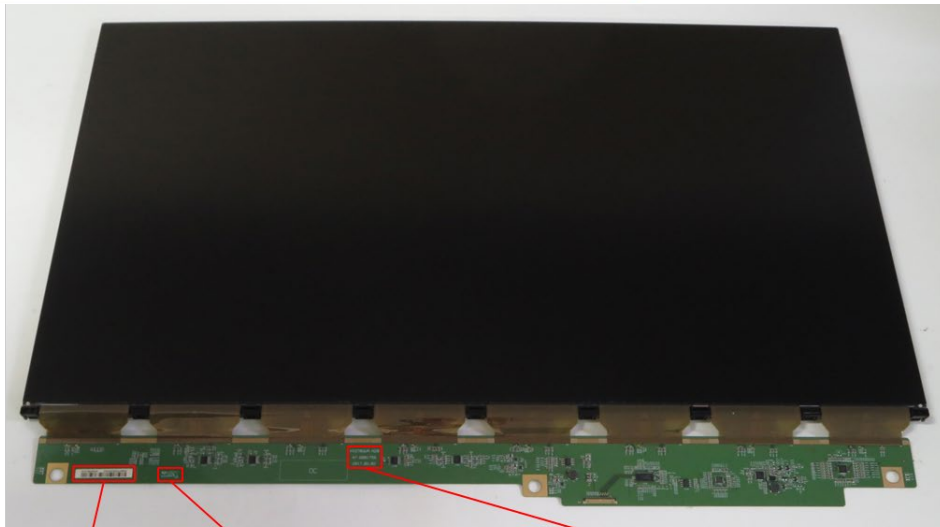

Front view

MV270QUMN20 2564AG08A9120899

BOE TRIPOD 42-9
E361035 01
94V-0
B089004AA0156-03
1846

MV270QUM-N20
47-6001756
2017.06.02

56. BOE LCD panels and modules, including, for example, the BOE LCD panel in the LG 27UK600 monitor, comprise an electro-optical device. The devices comprise LCD pixels that are used to display images made up of optical light.

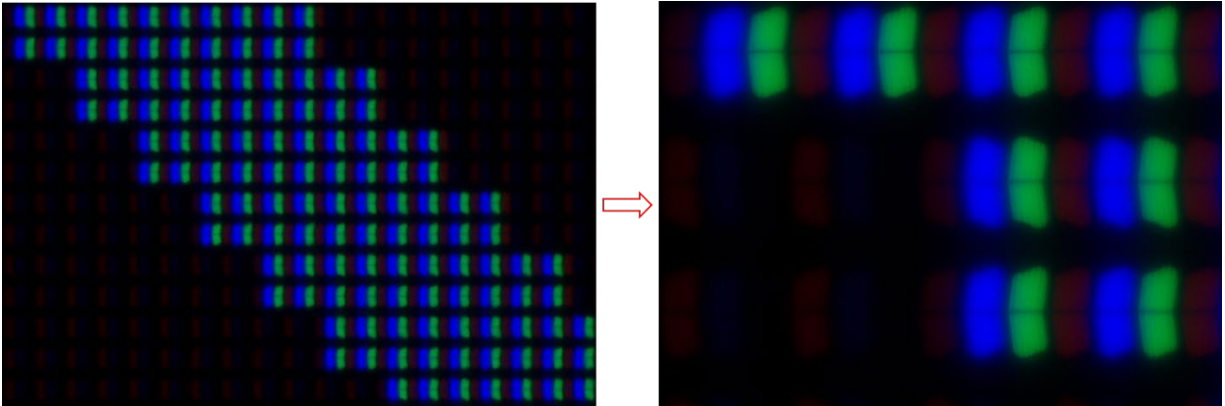

57. BOE LCD panels and modules, including, for example, the BOE LCD panel in the LG 27UK600 monitor, comprise a thin-film transistor having a channel area that extends in a direction and that intersects a predetermined direction that intersects the direction:

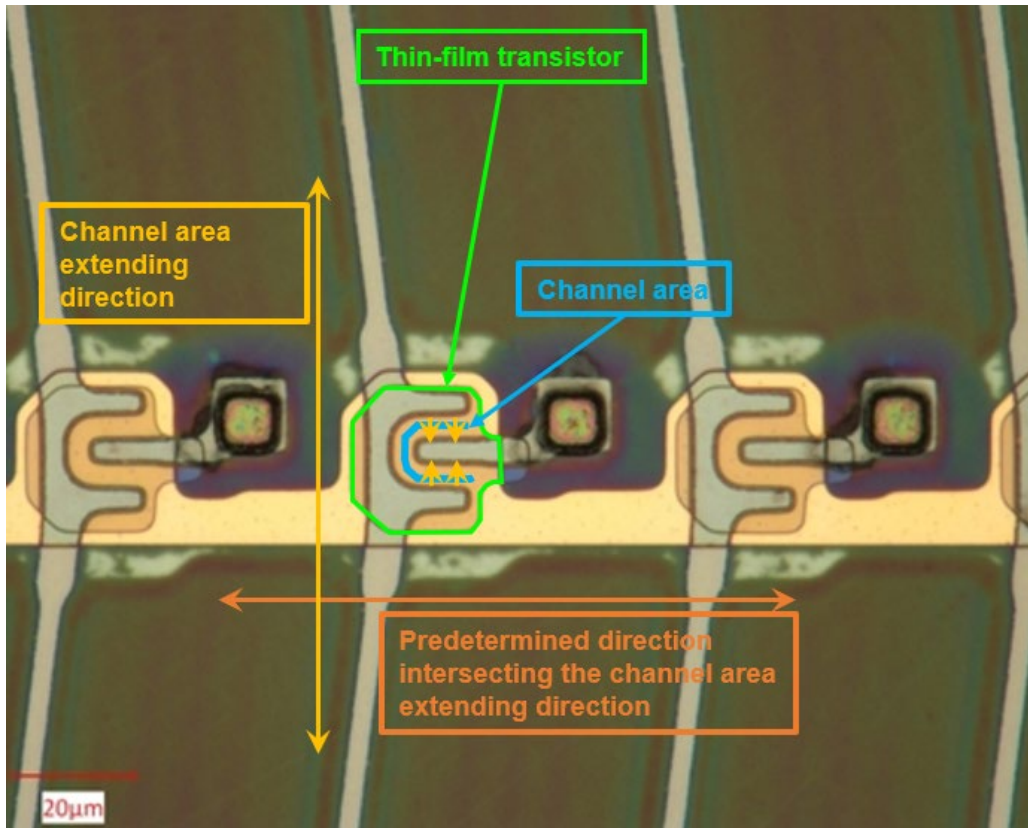
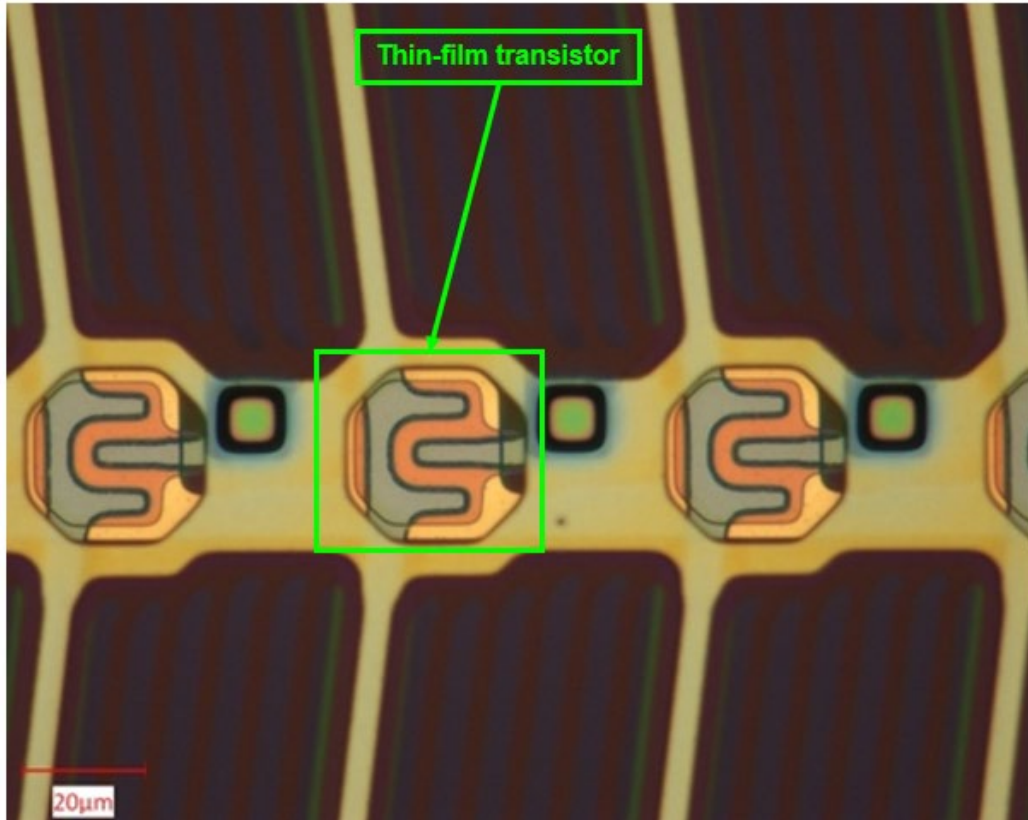

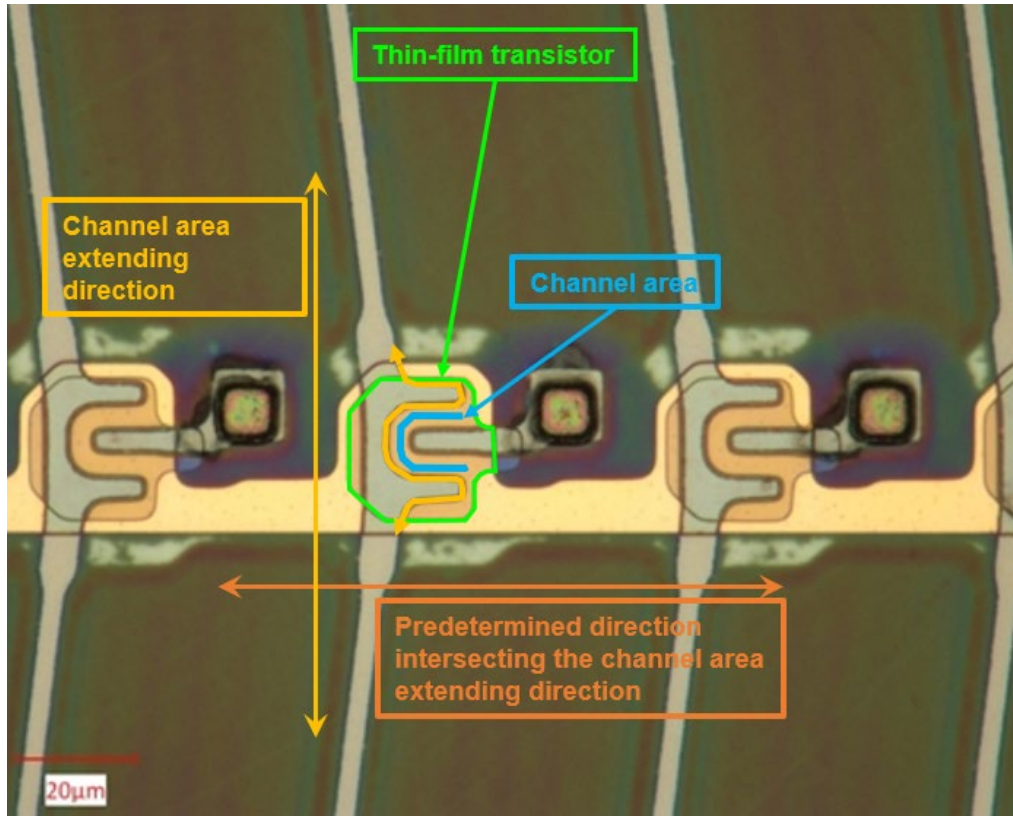

58. BOE LCD panels and modules, including, for example, the BOE LCD panel in the LG 27UK600 monitor, comprise a pixel electrode formed correspondingly to the thin-film transistor:

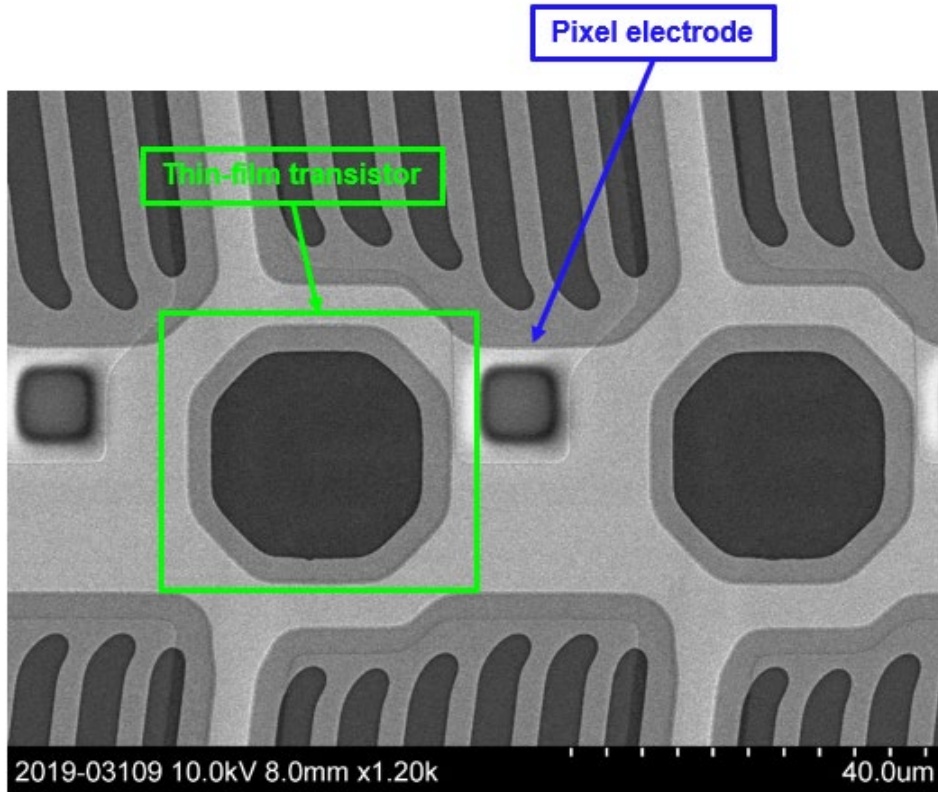
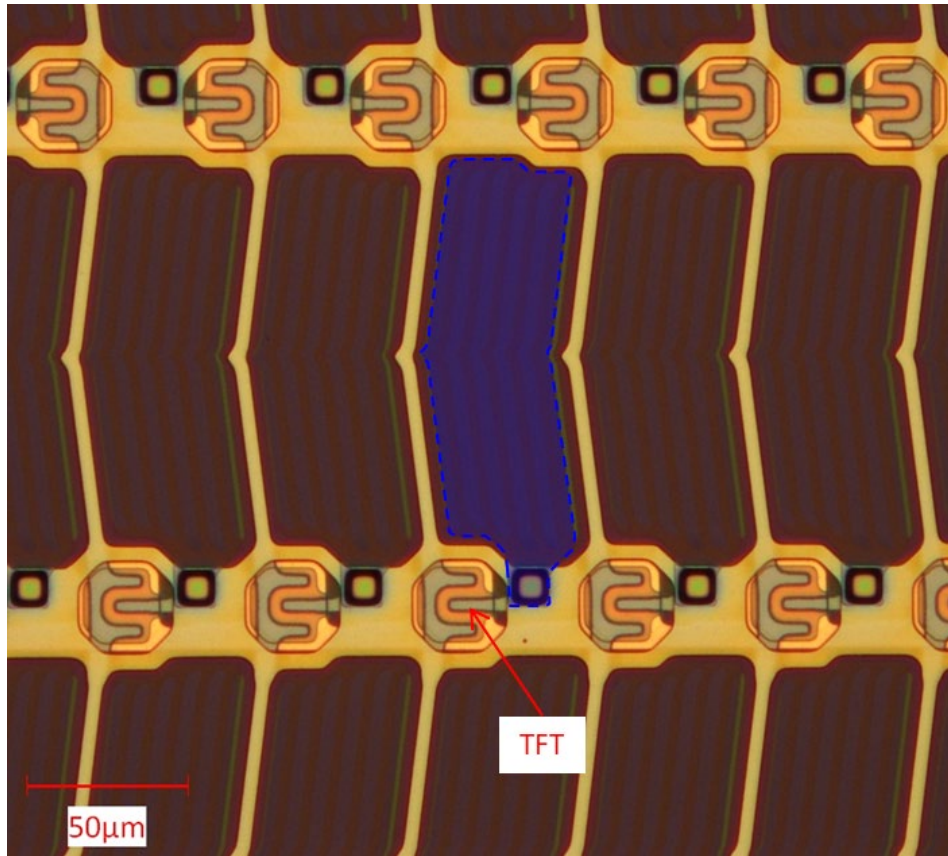

59. BOE LCD panels and modules, including, for example, the BOE LCD panel in the LG 27UK600 monitor, comprise a data line extending in the direction in which the channel area extends, the data line having a broad portion that overlaps the thin-film transistor and a non-broad portion that does not overlap the thin-film transistor, the broad portion being wider than the non-broad portion:

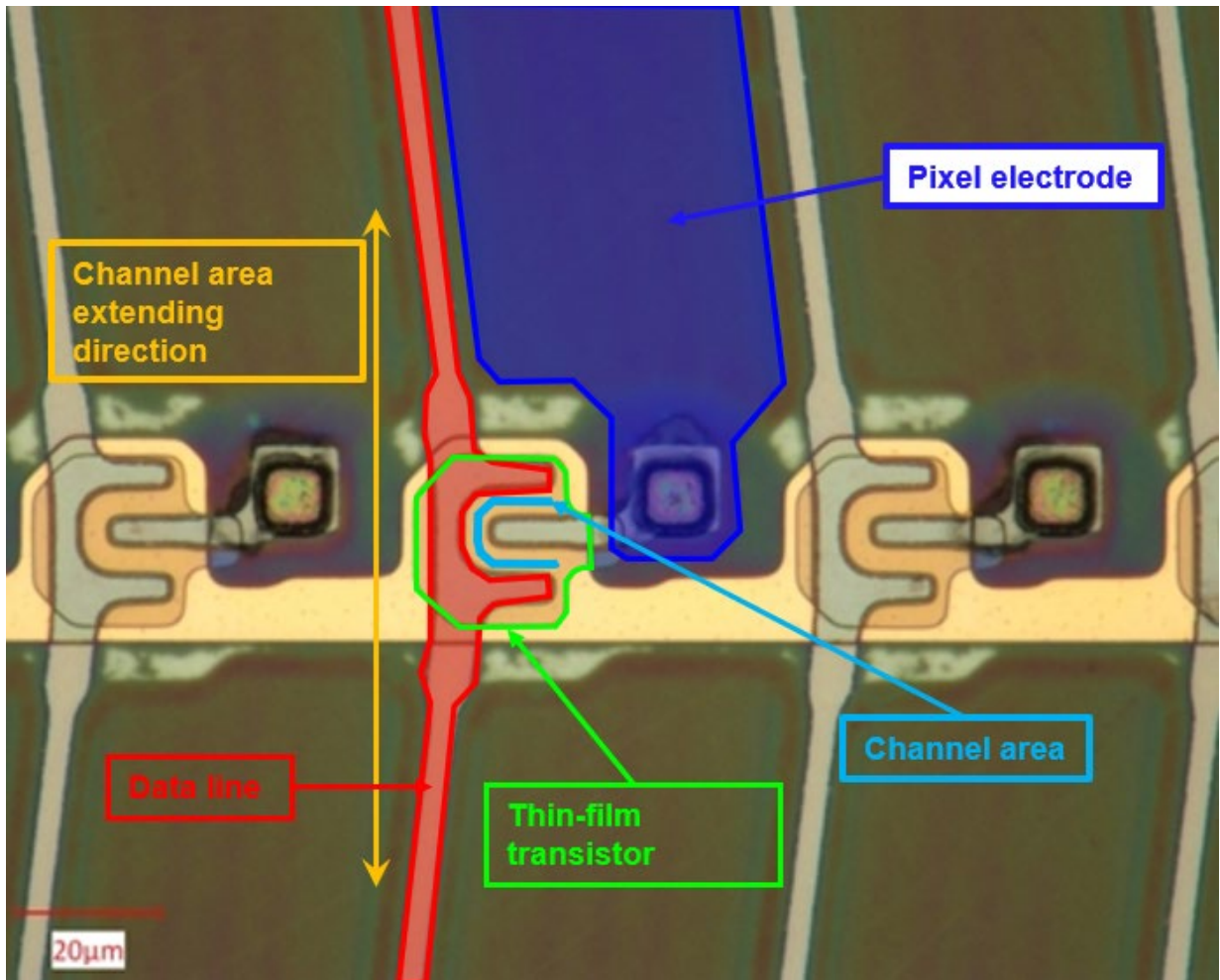

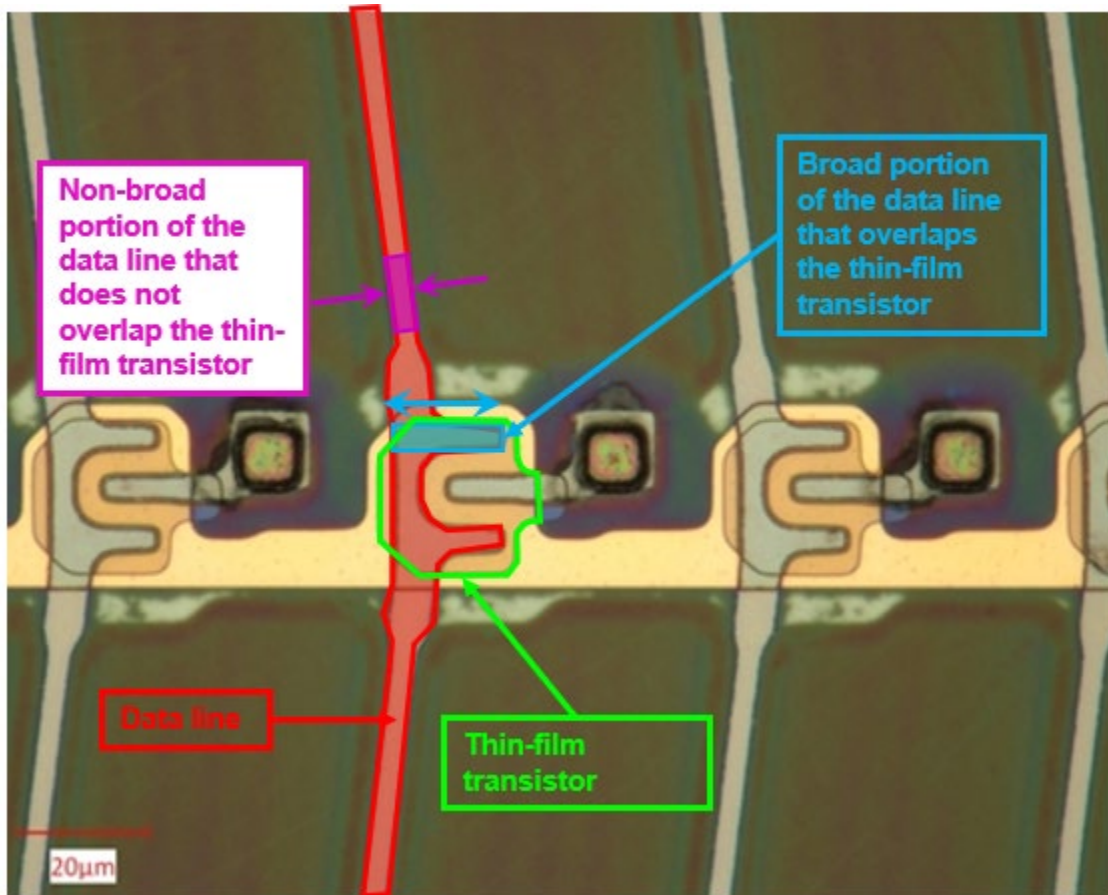

60. BOE LCD panels and modules, including, for example, the BOE LCD panel in the LG 27UK600 monitor, comprise a scanning line extending in the predetermined direction and intersecting the data line and the channel area of the thin-film transistor, the scanning line having a broad-width portion in a portion facing the channel area of the thin-film transistor and a narrow width portion in another portion:

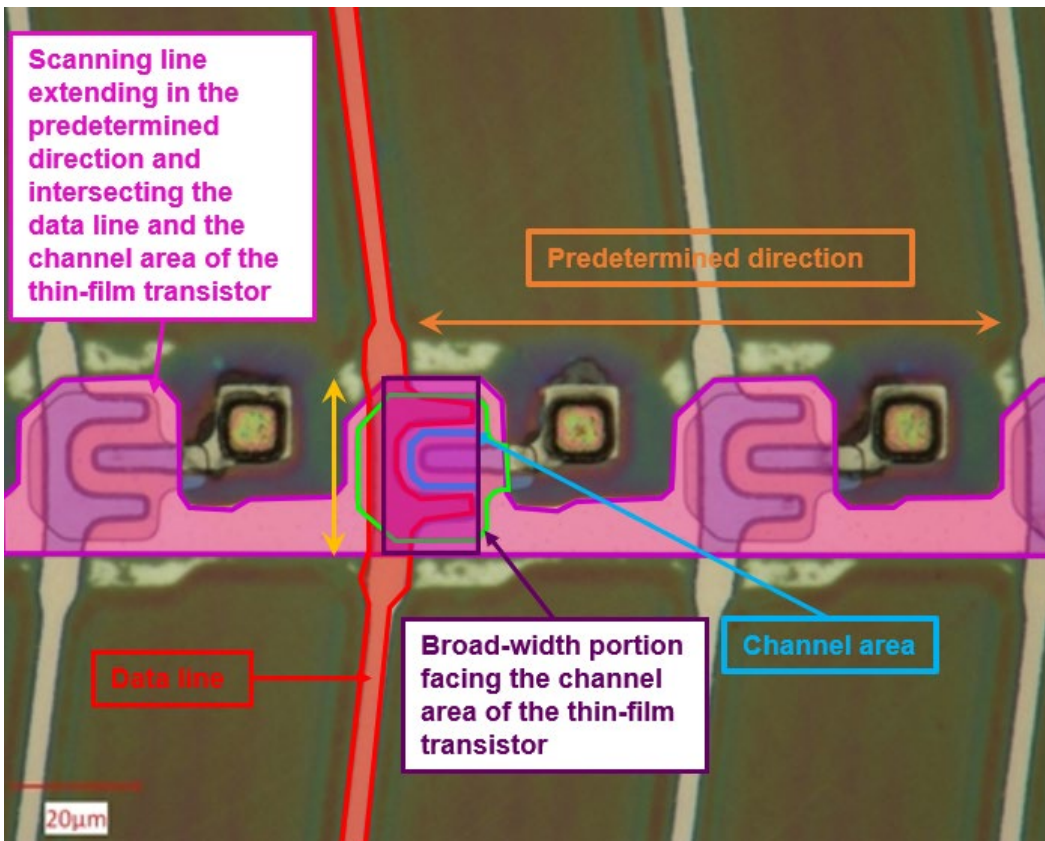
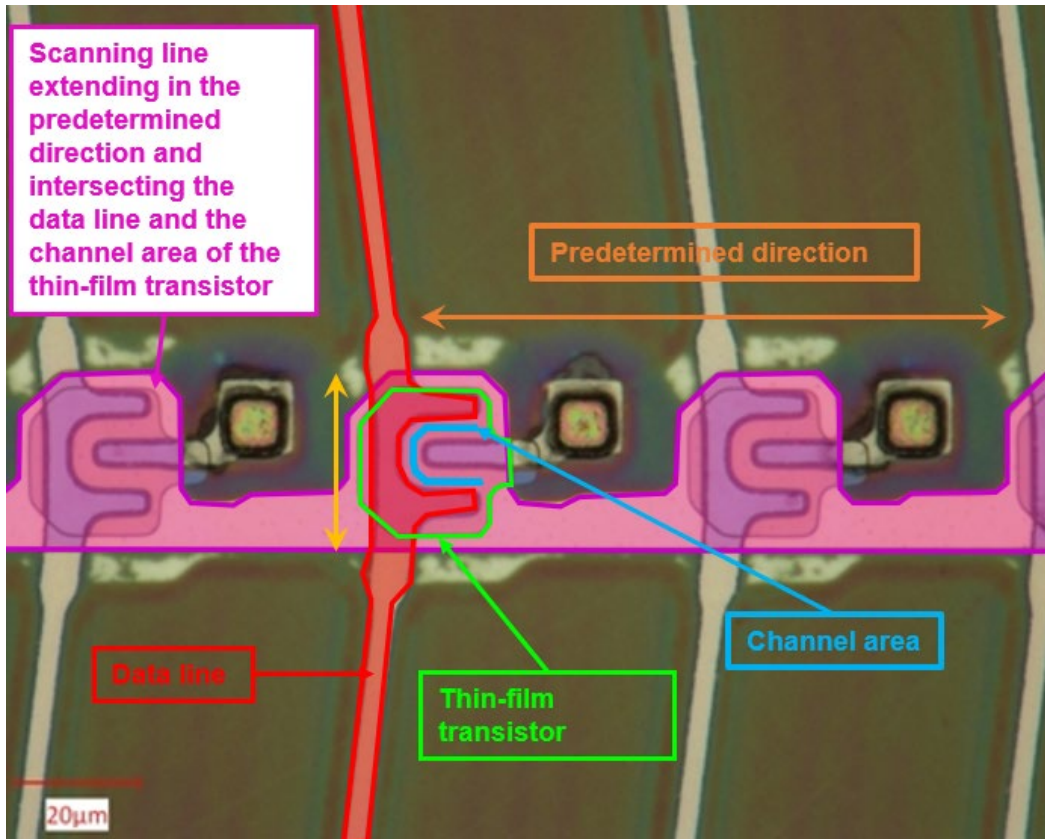

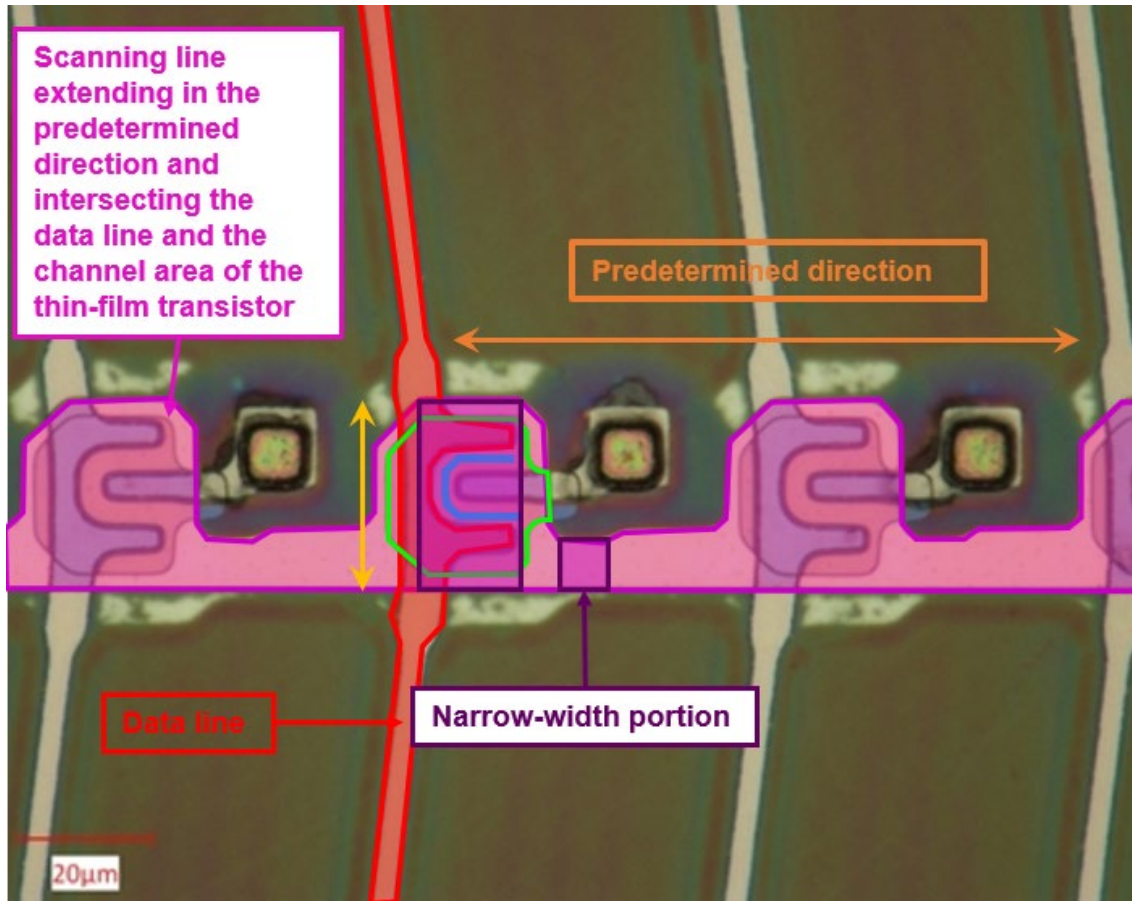

61. BOE LCD panels and modules, including, for example, the BOE LCD panel in the LG 27UK600 monitor, comprise a storage capacitor including a pixel-potential capacitor electrode, a fixed-potential capacitor electrode, and a dielectric film interposed between the pixel-potential capacitor electrode and the fixed potential capacitor electrode:

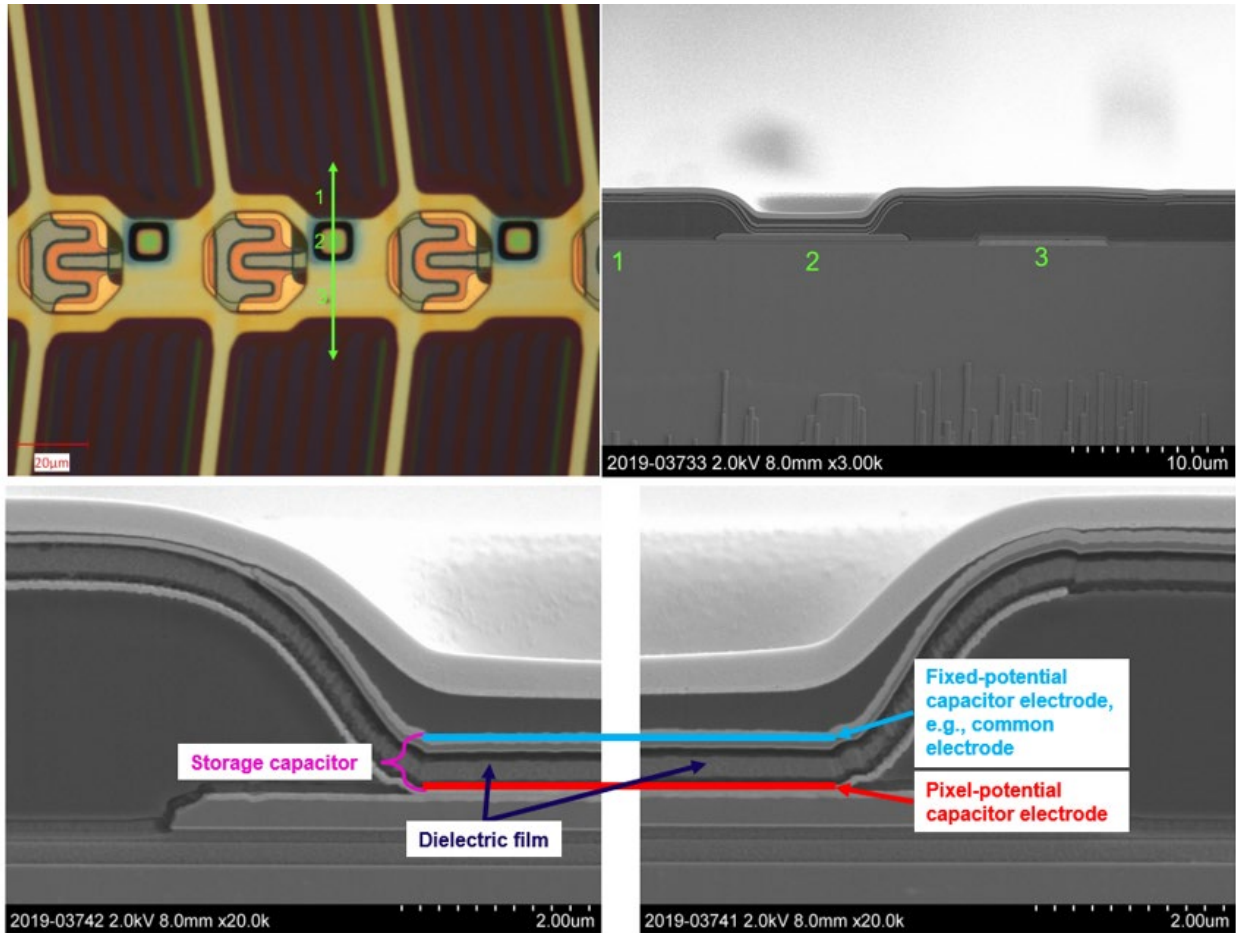

62. BOE LCD panels and modules, including, for example, the BOE LCD module present in the LG 27UK600 monitor, comprise a capacitive line having a portion that serves as the fixed-potential capacitor electrode of the storage capacitor, the capacitive line having a portion extending along the scanning line and a portion extending along the data line, the portion extending along the data line having a width that is narrower than the broad portion of the data line and that is wider than the non-broad portion of the data line:

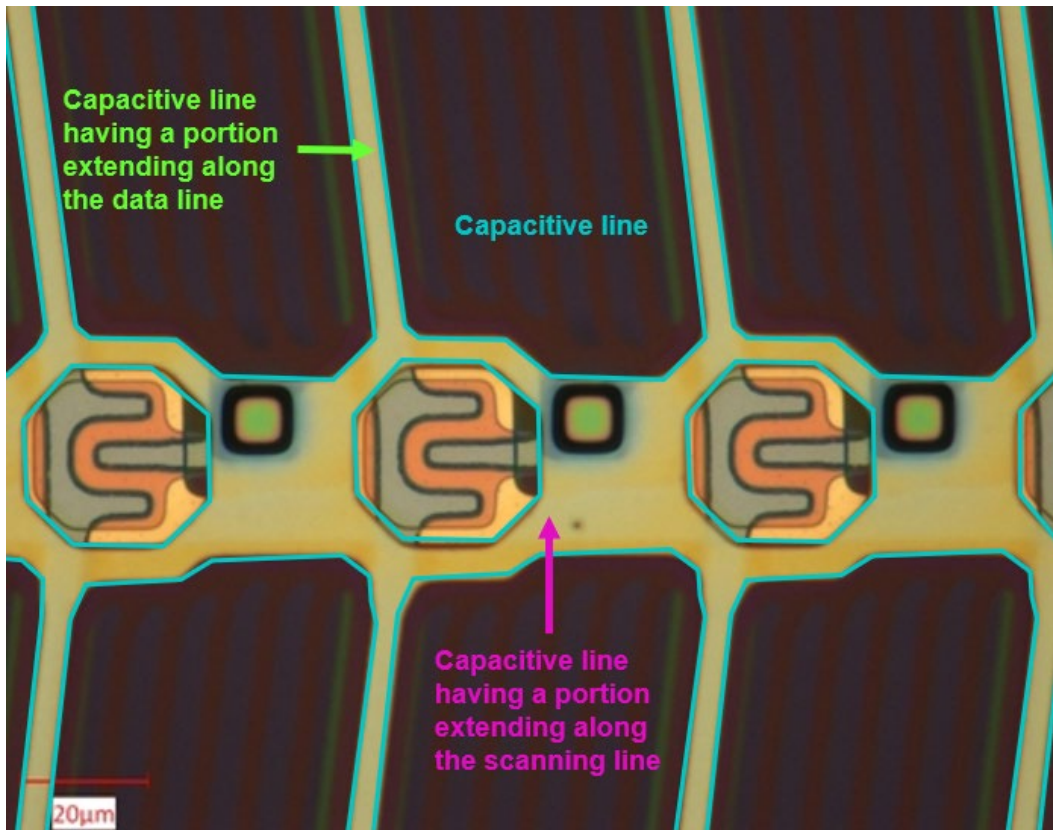
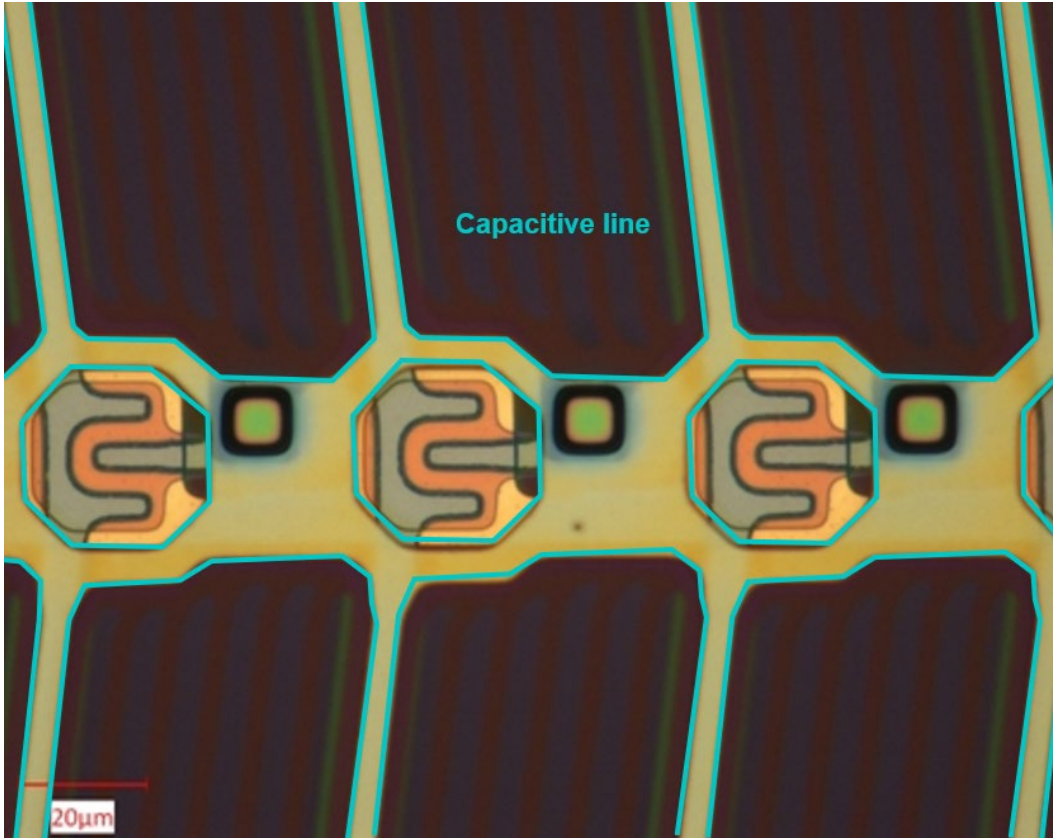

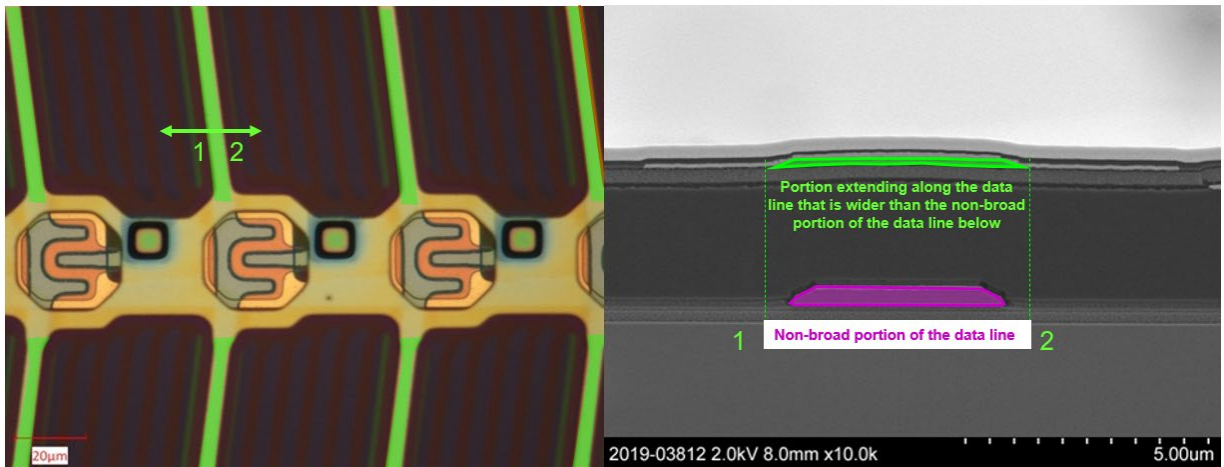
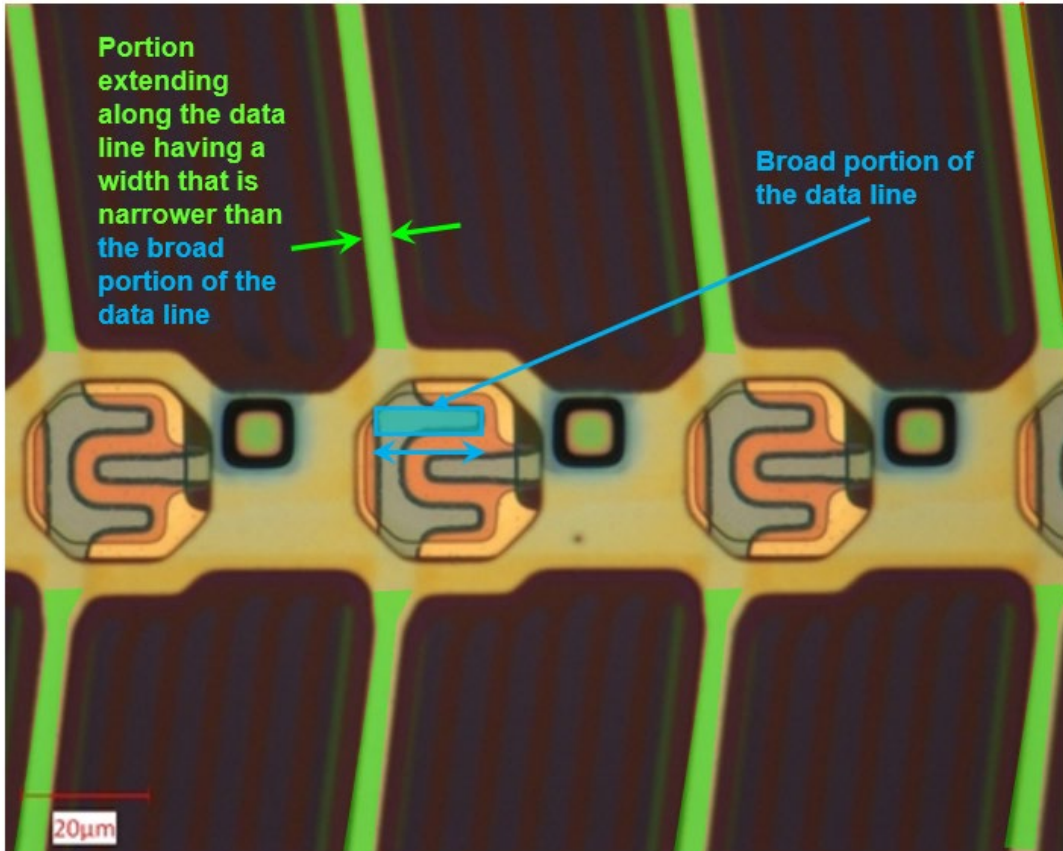

63. BOE has indirectly infringed and continues to indirectly infringe the '079 patent by actively inducing, in violation of 35 U.S.C. § 271(b), the direct infringement of the '079 patent by others in the United States, the State of Texas, and the Eastern District of Texas.

64. BOE has induced, and continues to induce, through affirmative acts, its customers and other third parties, including other importers, resellers, and end users in BOE's supply chain, to directly infringe the '079 patent by making, using, offering to sell, selling within the United States, and/or importing into the United States Accused Instrumentalities that infringe the '079 patent.

65. On information and belief, BOE actively promoted the Accused Instrumentalities for the U.S. market, as alleged here.

66. BOE knew that its customers would offer to sell and/or sell infringing Accused Instrumentalities in the United States or cause Accused Instrumentalities to be sold in the United States, and BOE specifically intended its customers to purchase Accused Instrumentalities from BOE and offer to sell and/or sell the Accused Instrumentalities in the United States or cause Accused Instrumentalities to be sold in the United States. BOE's direct and indirect purchasers directly infringe the '079 patent by importing such Accused Instrumentalities into the United States, selling such Accused Instrumentalities in the United States, offering to sell such Accused Instrumentalities in the United States, and/or using such Accused Instrumentalities in the United States.

67. BOE has induced others' direct infringement despite actual notice that the Accused Instrumentalities infringe the '079 patent. As of at least September 28, 2023, BOE knew that the induced conduct would constitute infringement—and intended that infringement at the time of committing the aforementioned affirmative acts, such that the acts and conduct have been and continue to be committed with the specific intent to induce infringement—or deliberately avoided learning of the infringing circumstances at

the time of committing these acts so as to be willfully blind to the infringement that was induced.

68. BOE's direct and indirect infringement of the '079 patent is ongoing.

69. The above-described acts of infringement have caused and continue to cause injury and damage to Longitude.

70. BOE's infringement has been and continues to be willful.

71. Longitude is entitled to recover damages sustained as a result of BOE's willful infringement in an amount subject to proof at trial, but in no event less than a reasonable royalty.

COUNT II: INFRINGEMENT OF U.S. PATENT NO. 7,705,948

72. Pursuant to 35 U.S.C. § 282, the '948 patent is presumed valid.

73. BOE has directly infringed and continues to directly infringe one or more claims of the '948 patent, in violation of 35 U.S.C. § 271(a).

74. The Accused Instrumentalities directly infringe at least claim 1 of the '948 patent.

75. Paragraphs 77-92 describe the manner in which the Accused Instrumentalities infringe claim 1 of the '948 patent, by way of the exemplary BOE panel in the LG 27-inch 27UK600 monitor. Longitude's allegations of infringement are not limited to claim 1 or the exemplary product, and additional infringement will be identified and disclosed through discovery and in infringement contentions.

76. The panel in the LG 27-inch 27UK600 monitor is a BOE panel, as indicated by the "BOE" logo on the panel casing and the printed circuit board:

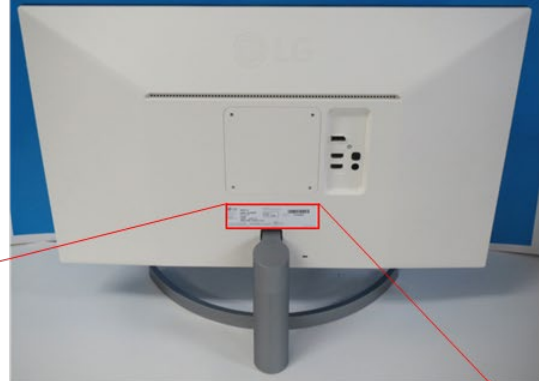

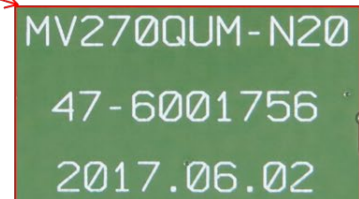
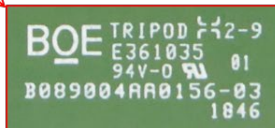
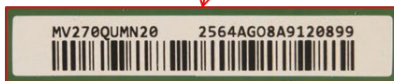
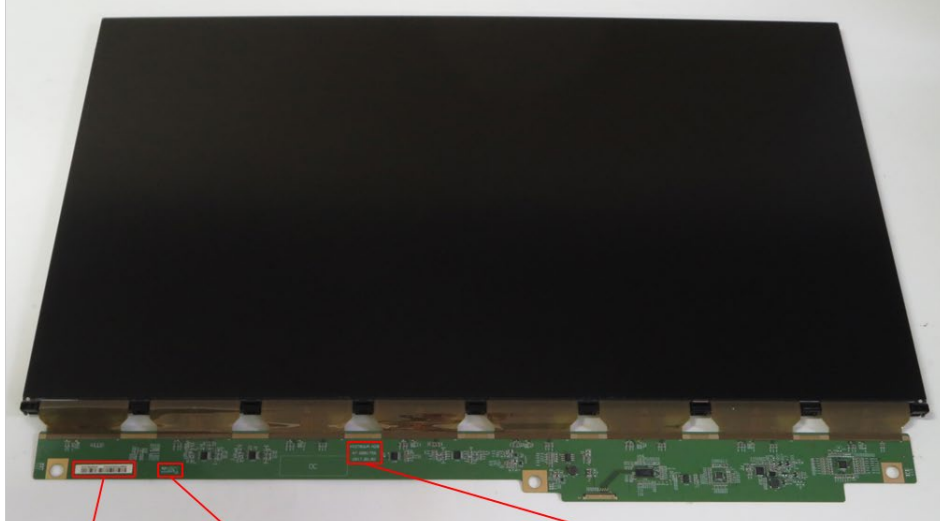
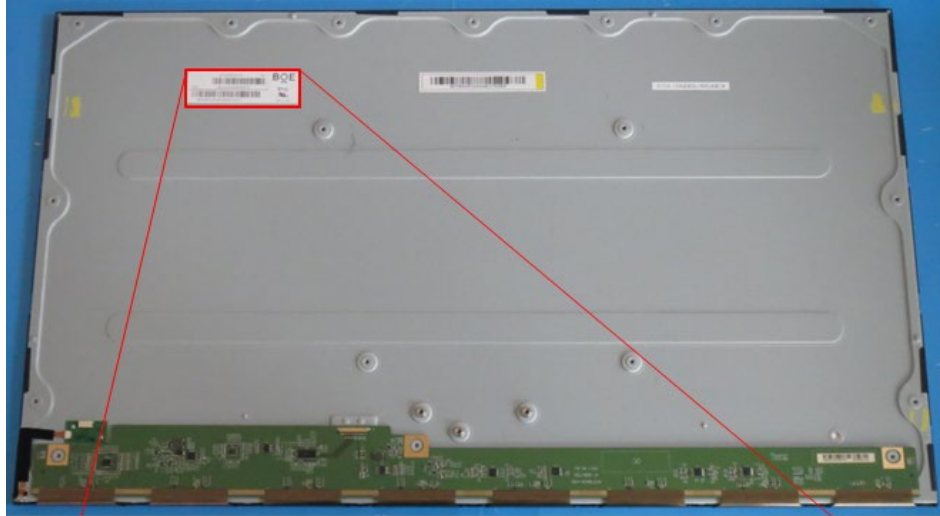

77. BOE LCD panels and modules, including, for example, the BOE panel in

the LG 27-inch 27UK600 monitor, comprise a liquid crystal display device. The devices comprise LCD pixels that are used to display images made up of optical light:

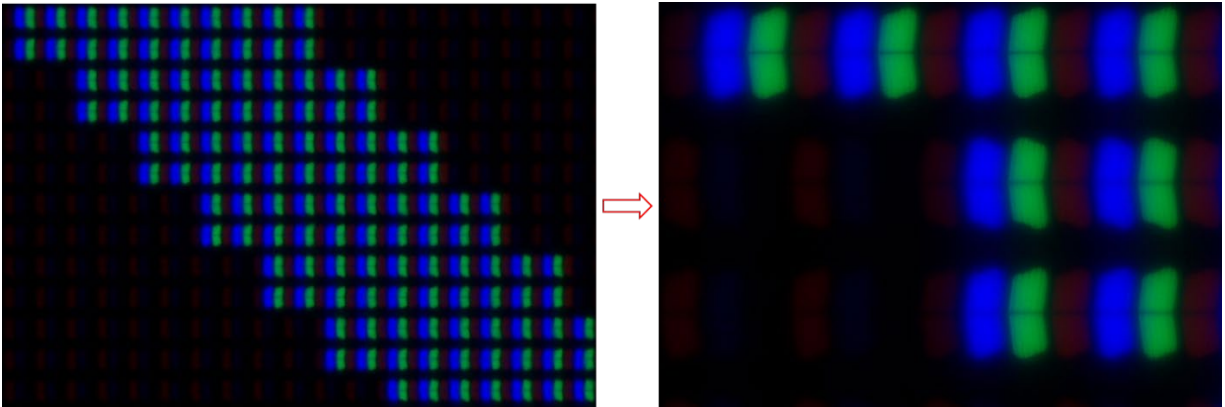

78. BOE LCD panels and modules, including, for example, the BOE panel in the LG 27-inch 27UK600 monitor, comprise a substrate:

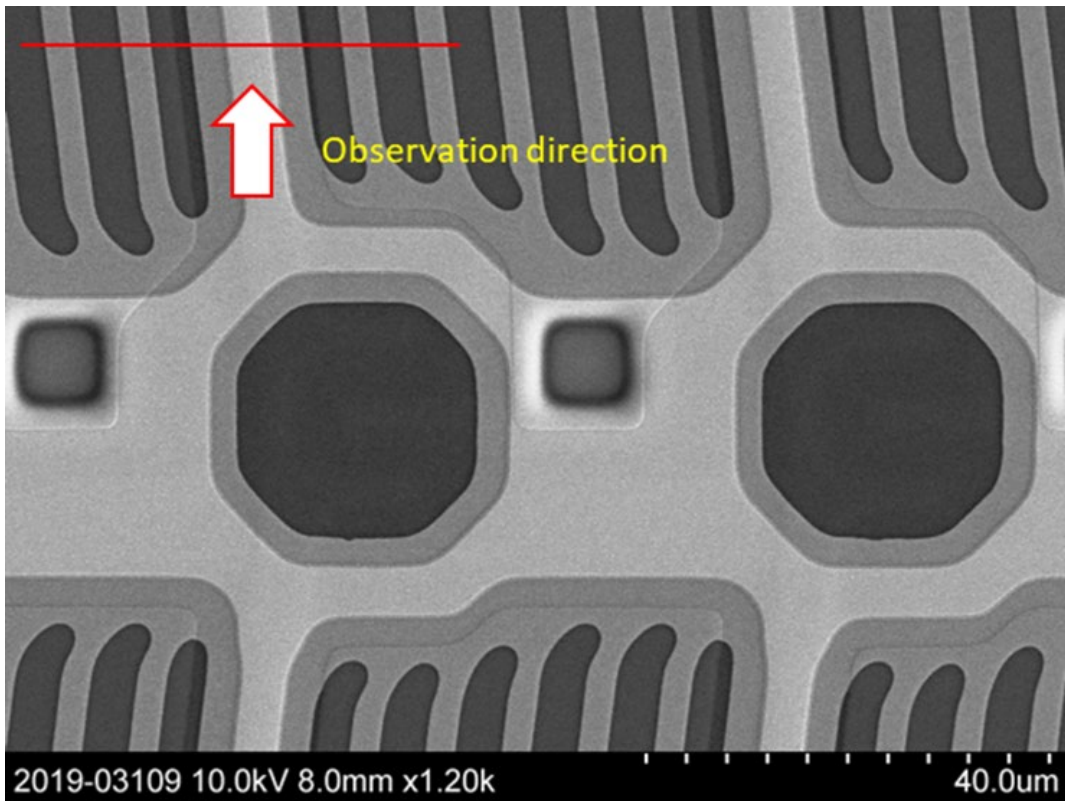

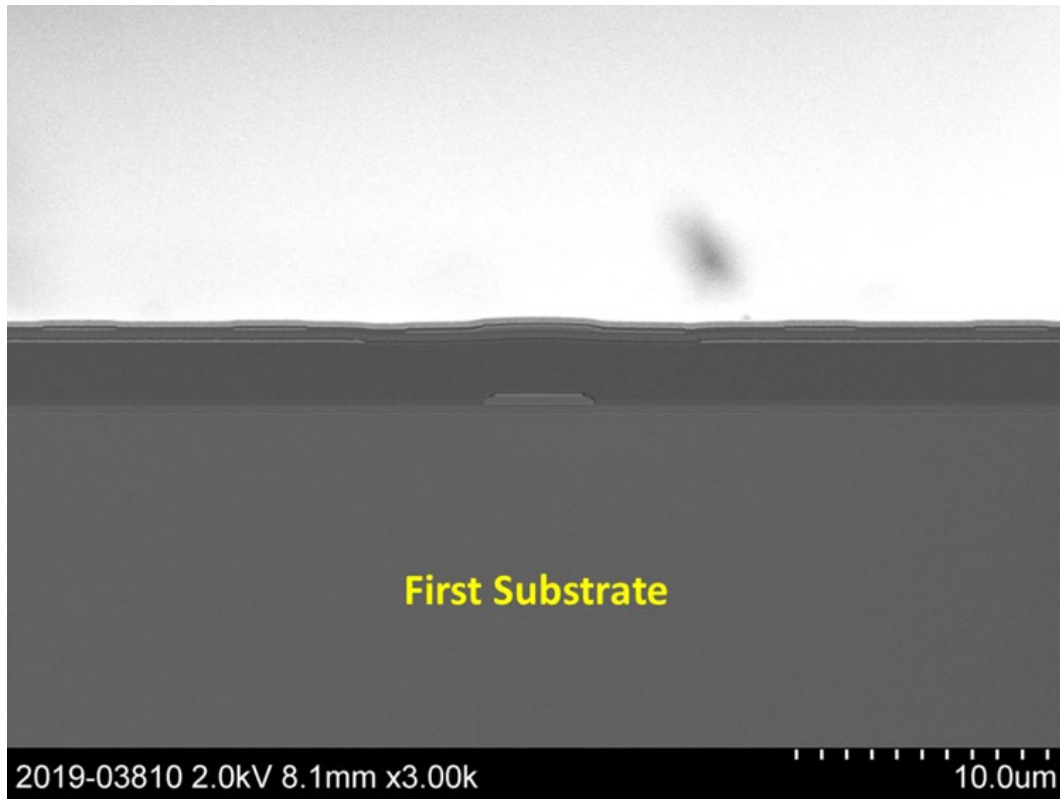

79. BOE LCD panels and modules, including, for example, the BOE panel in the LG 27-inch 27UK600 monitor, comprise an upper electrode layer formed on the substrate, the upper electrode layer having slits:

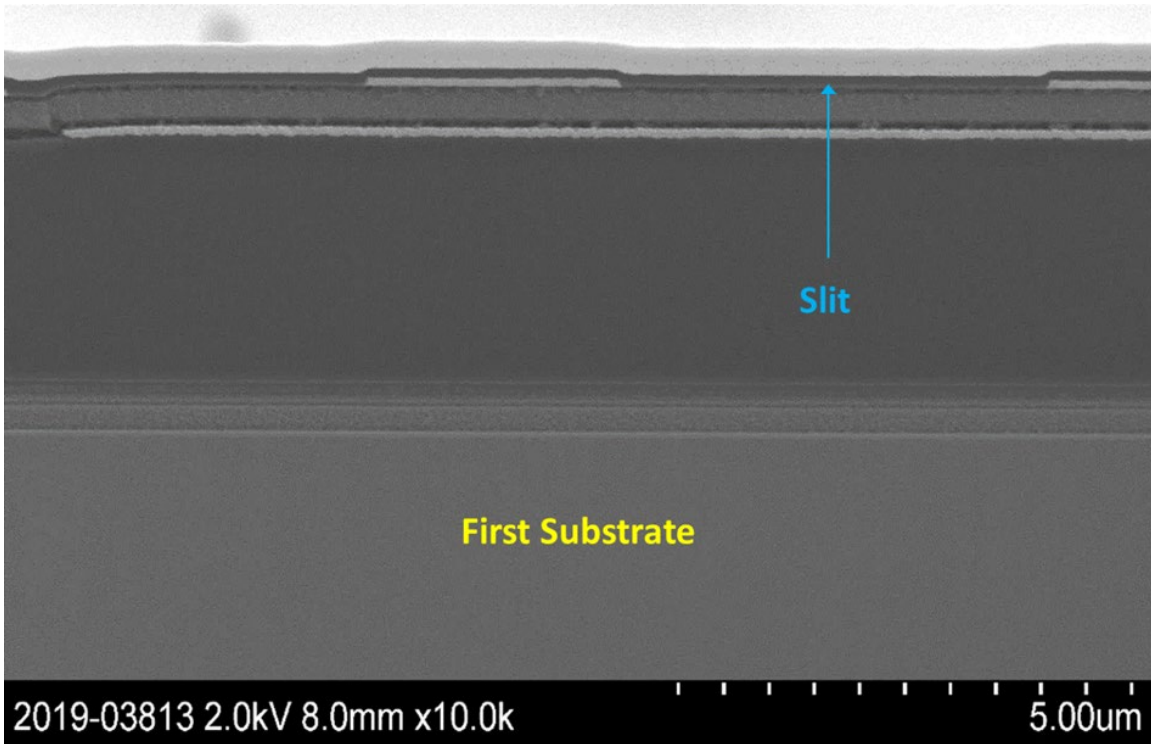
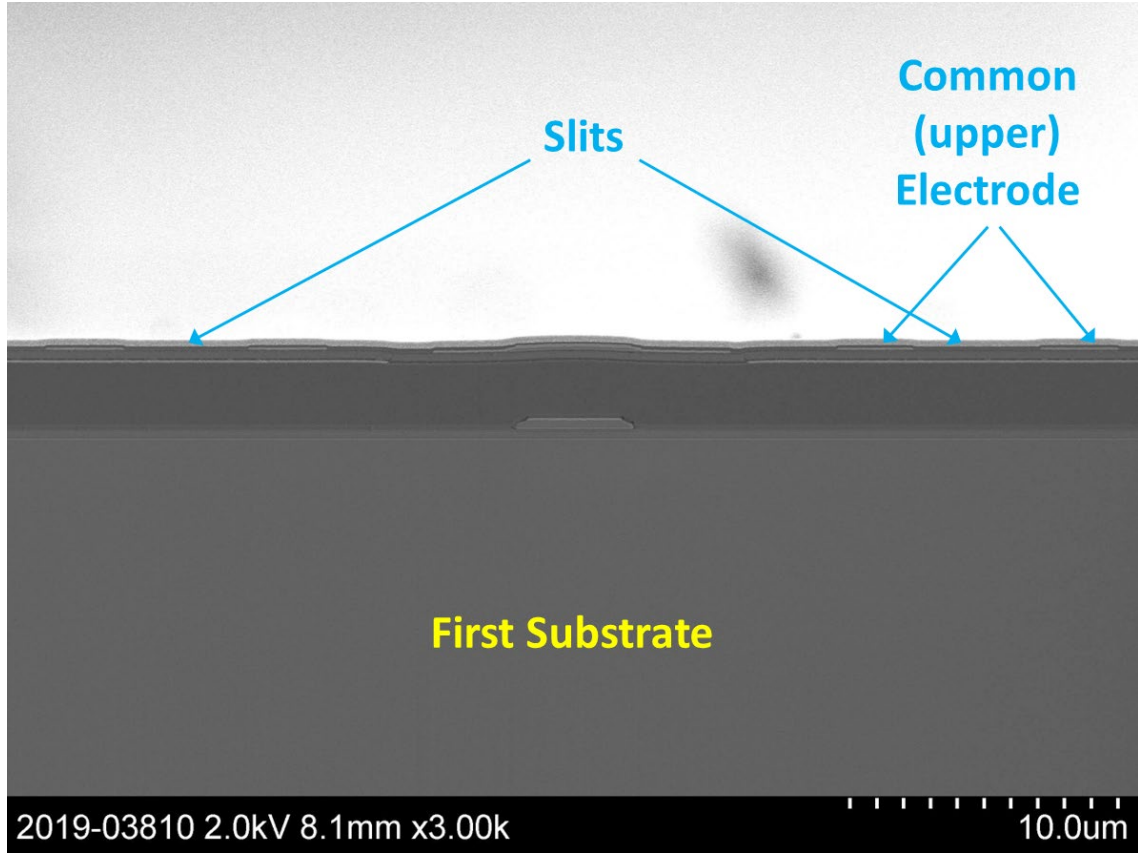

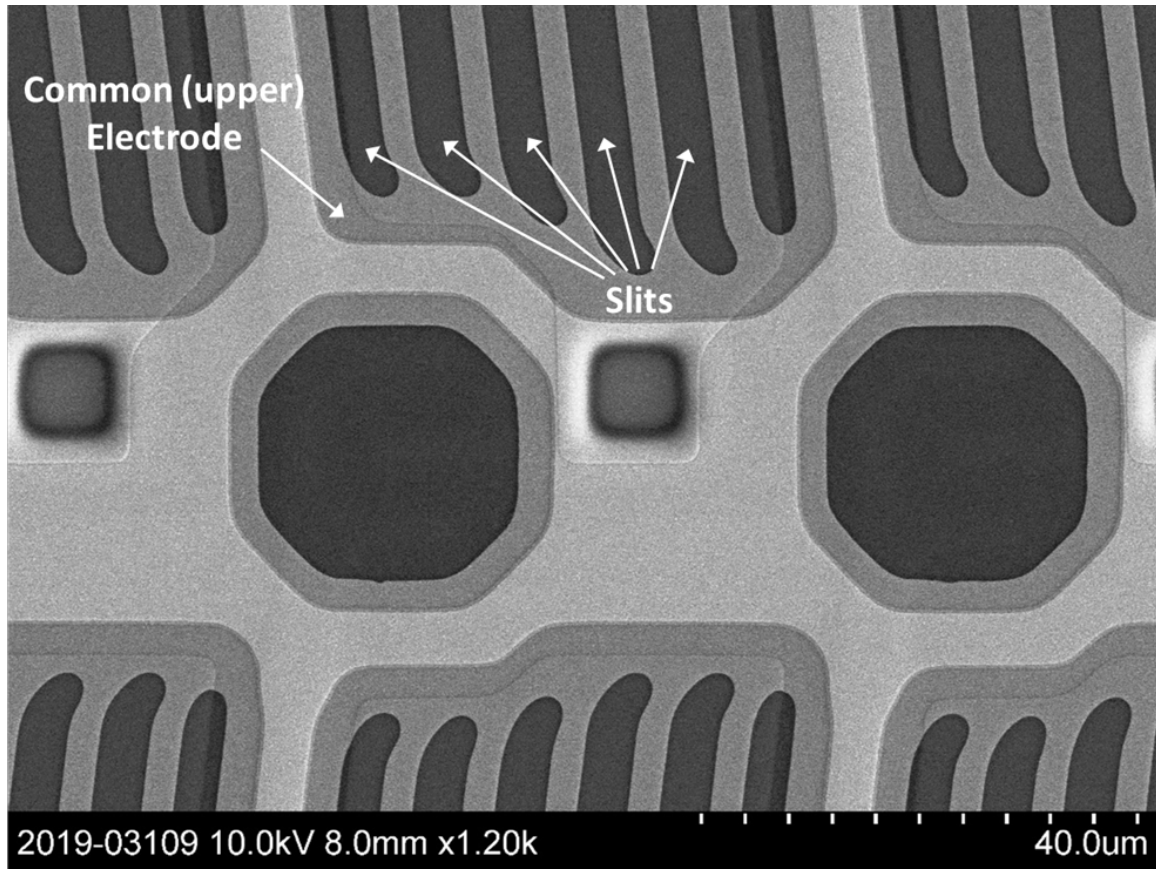

80. BOE LCD panels and modules, including, for example, the BOE panel in the LG 27-inch 27UK600 monitor, comprise an insulating layer formed between the substrate and the upper electrode layer:

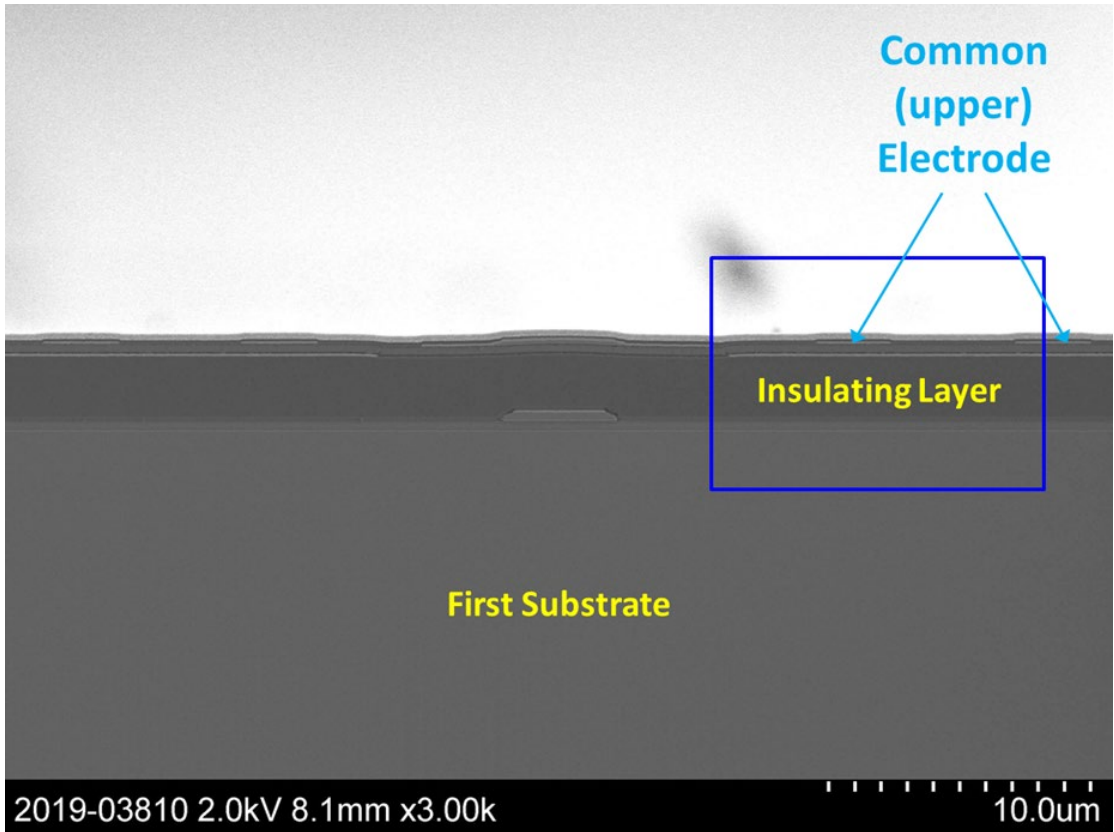
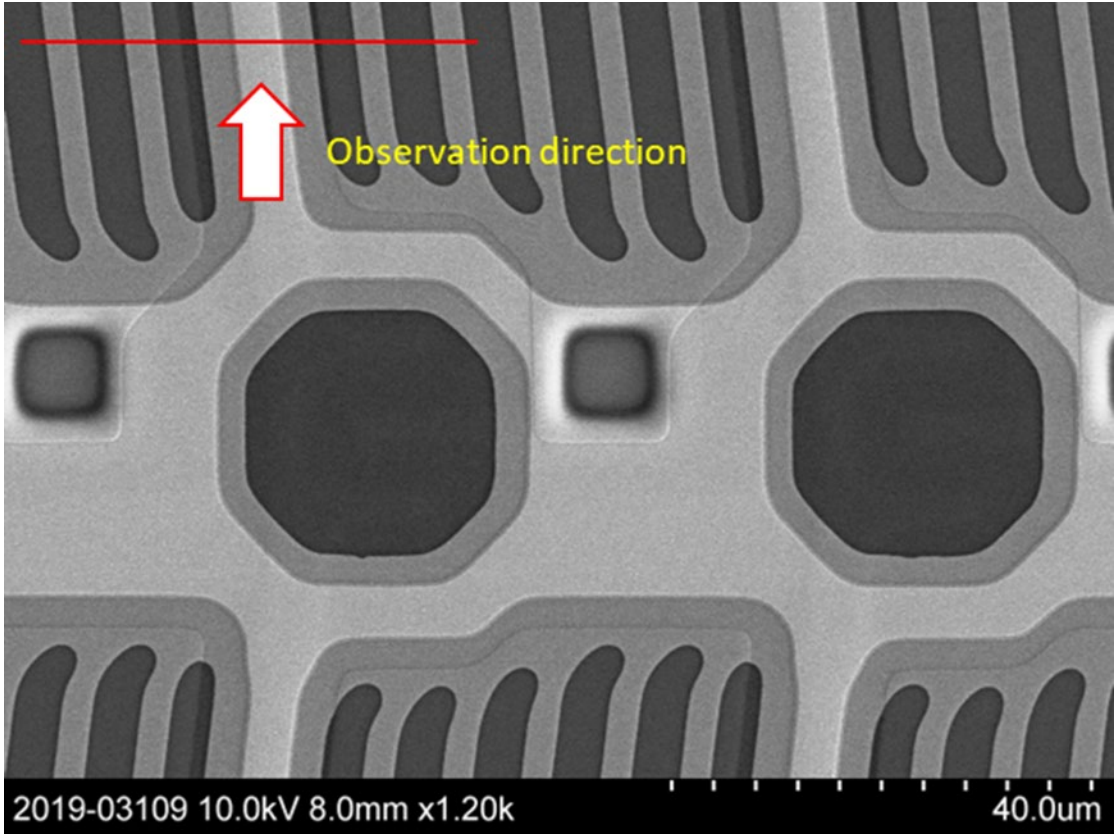

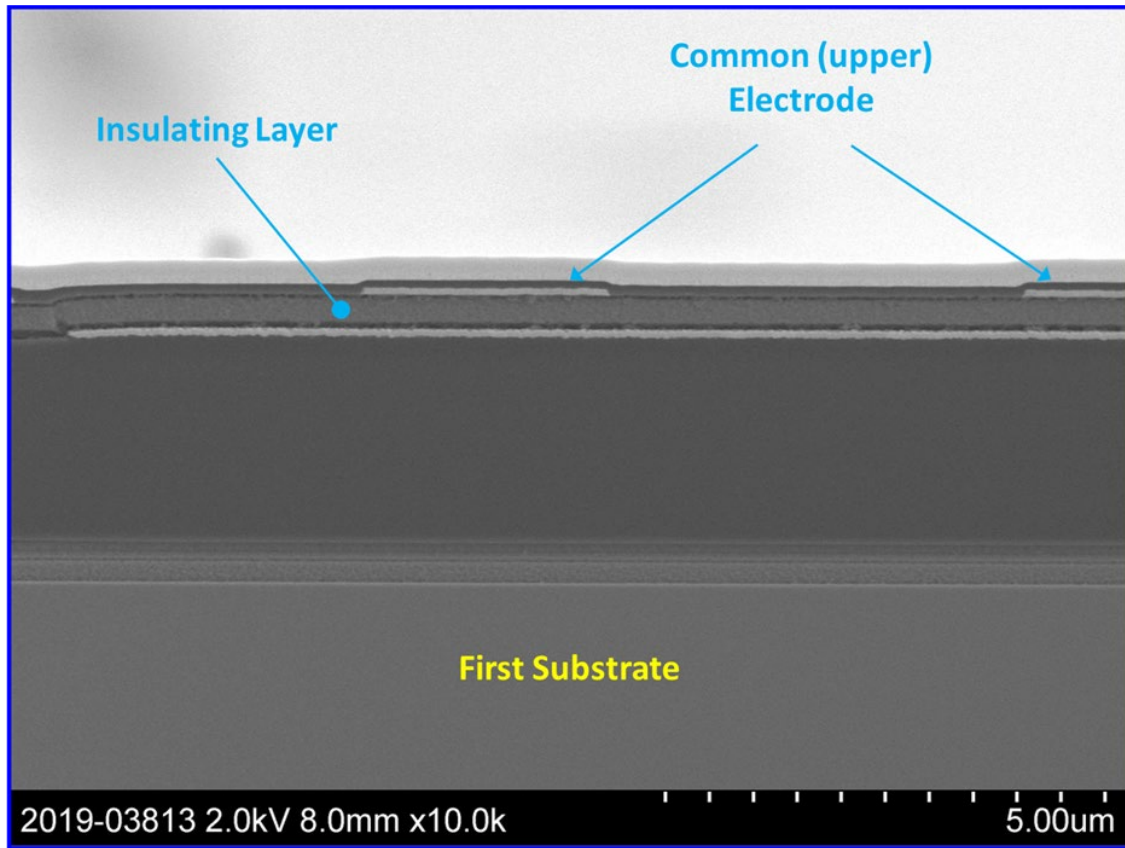

81. BOE LCD panels and modules, including, for example, the BOE panel in the LG 27-inch 27UK600 monitor, comprise a lower electrode layer formed between the substrate and the insulating layer:

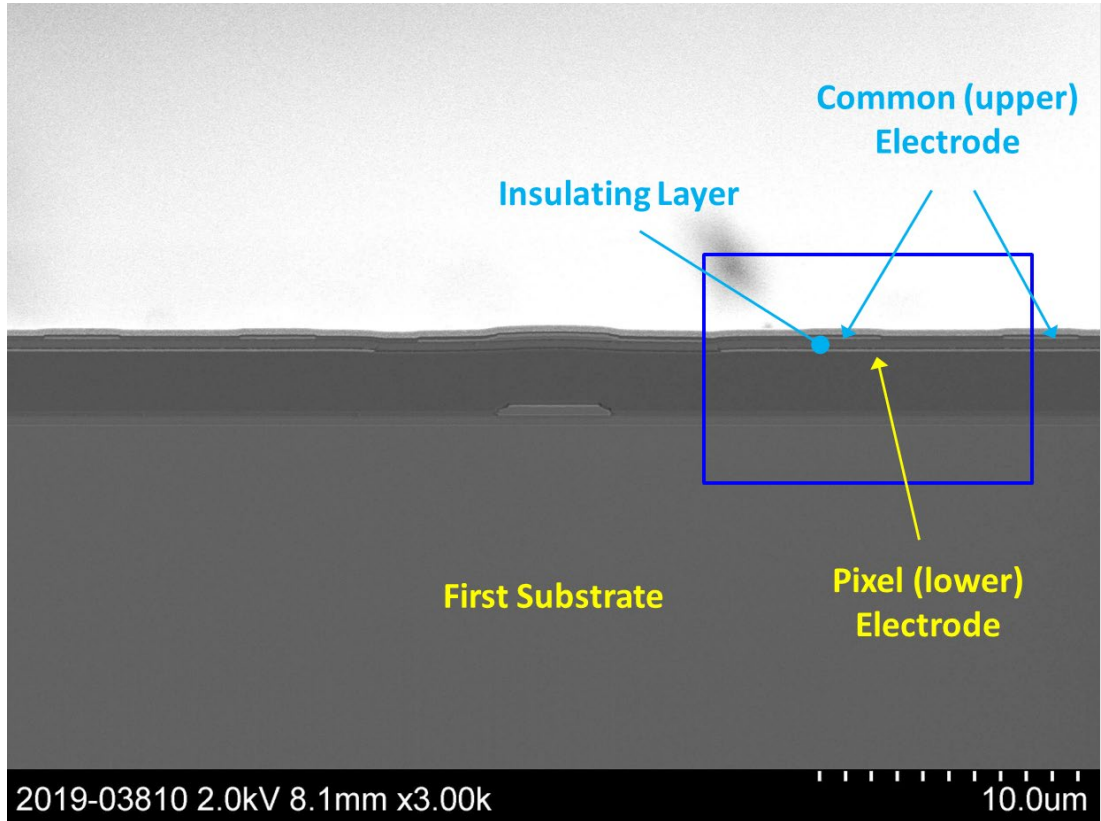
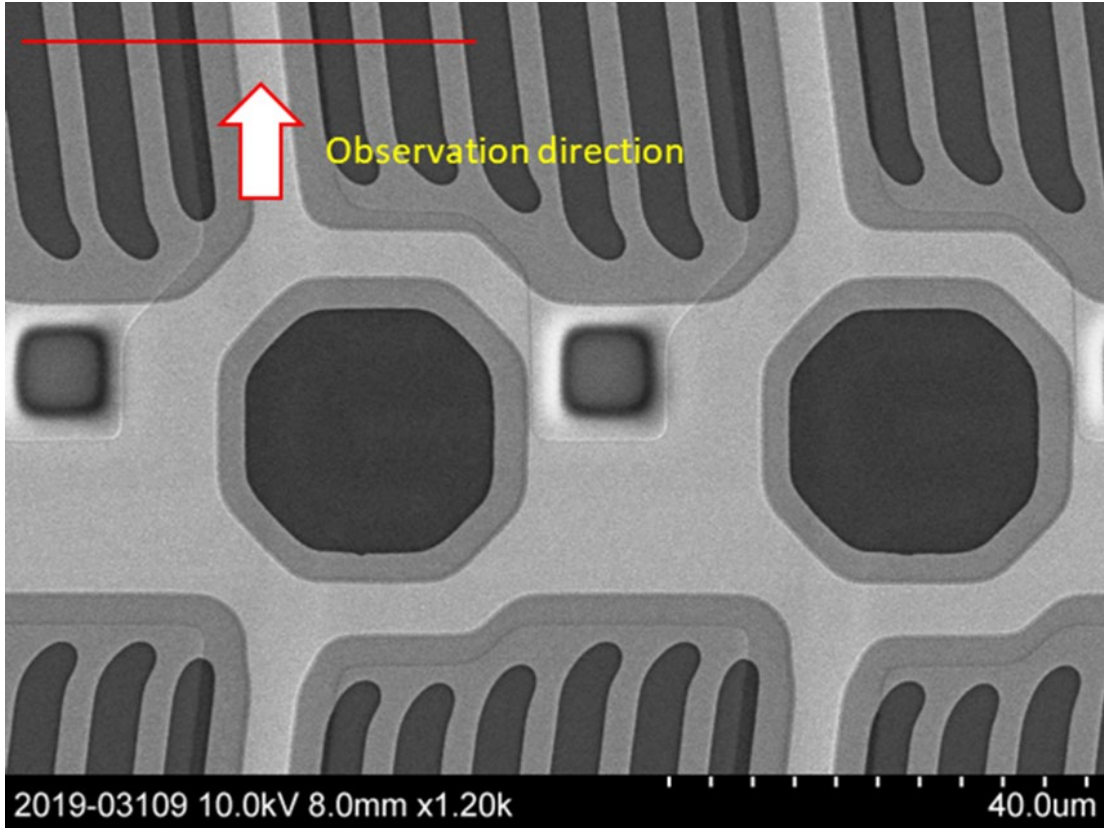

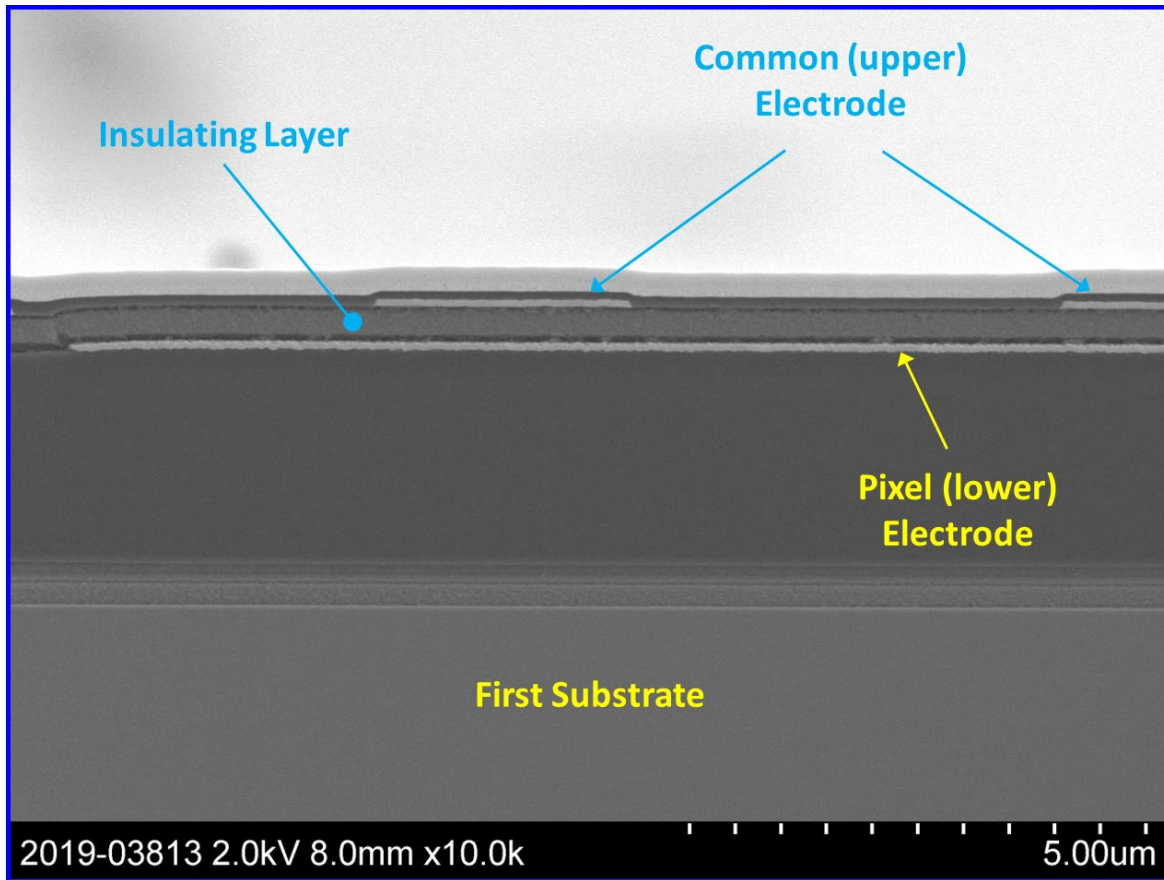

82. BOE LCD panels and modules, including, for example, the BOE panel in the LG 27-inch 27UK600 monitor, comprise the slits described *supra*, the slits allowing for application of a voltage between the upper electrode layer and the lower electrode layer, the voltage driving liquid crystal molecules. It is well-established that the operating mechanism for fringe-field switched LCD panels, such as the LG 27-inch 27UK600 monitor as evidenced by the presence of slits in one of the common or pixel electrodes, is an electric field generated by the voltage drop between positively and negatively charged electrodes placed opposite each other. More particularly, the slits in one electrode (either the pixel or the common electrode) facilitate the generation of a lateral electric field along which the LC molecules will align when the voltage is applied, as shown for “FFS mode”

(d) below:

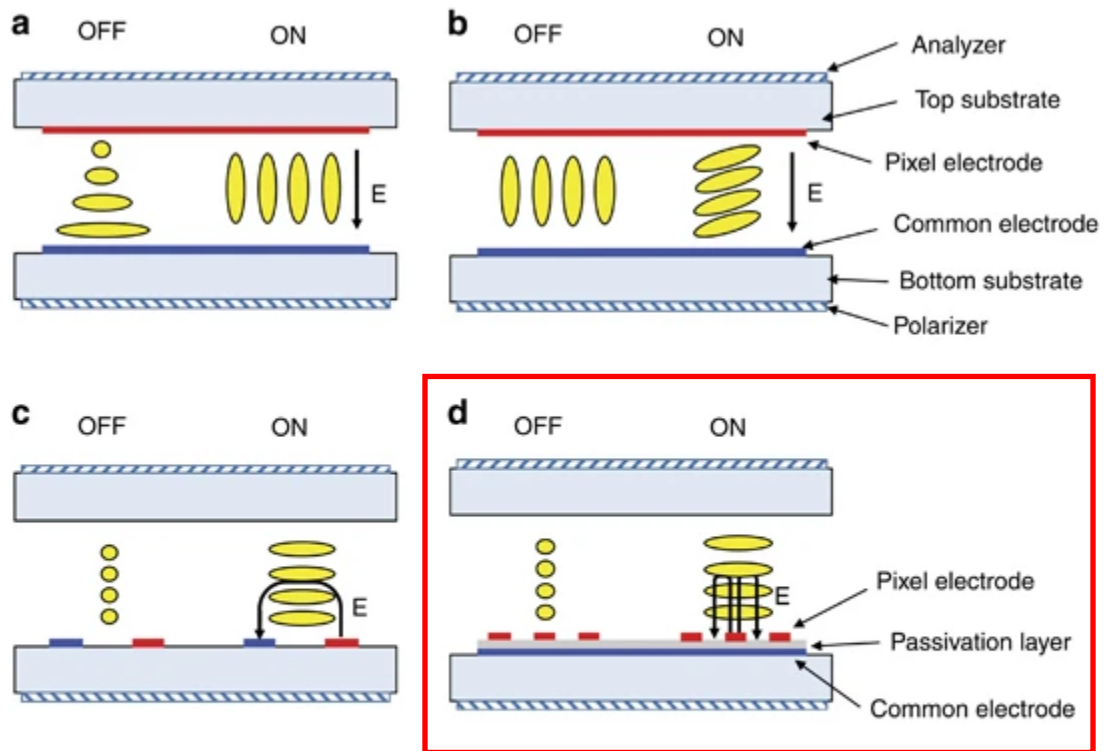

Schematic diagram of the (a) TN mode, (b) VA mode, (c) IPS mode and (d) FFS mode. The LC director orientations are shown in the voltage-off (left) and voltage-on (right) states.

<https://www.nature.com/articles/lisa2017168/figures/2> (last accessed Nov. 8, 2023).

83. BOE LCD panels and modules, including, for example, the BOE panel in the LG 27-inch 27UK600 monitor, comprise the upper electrode layer and the lower electrode layer formed on a same substrate via the insulating layer. Both the common (upper) electrode layer and pixel (lower) electrode layer are formed on the same substrate (“First Substrate”), with the insulating layer residing between the upper electrode layer and the lower electrode layer, as shown:

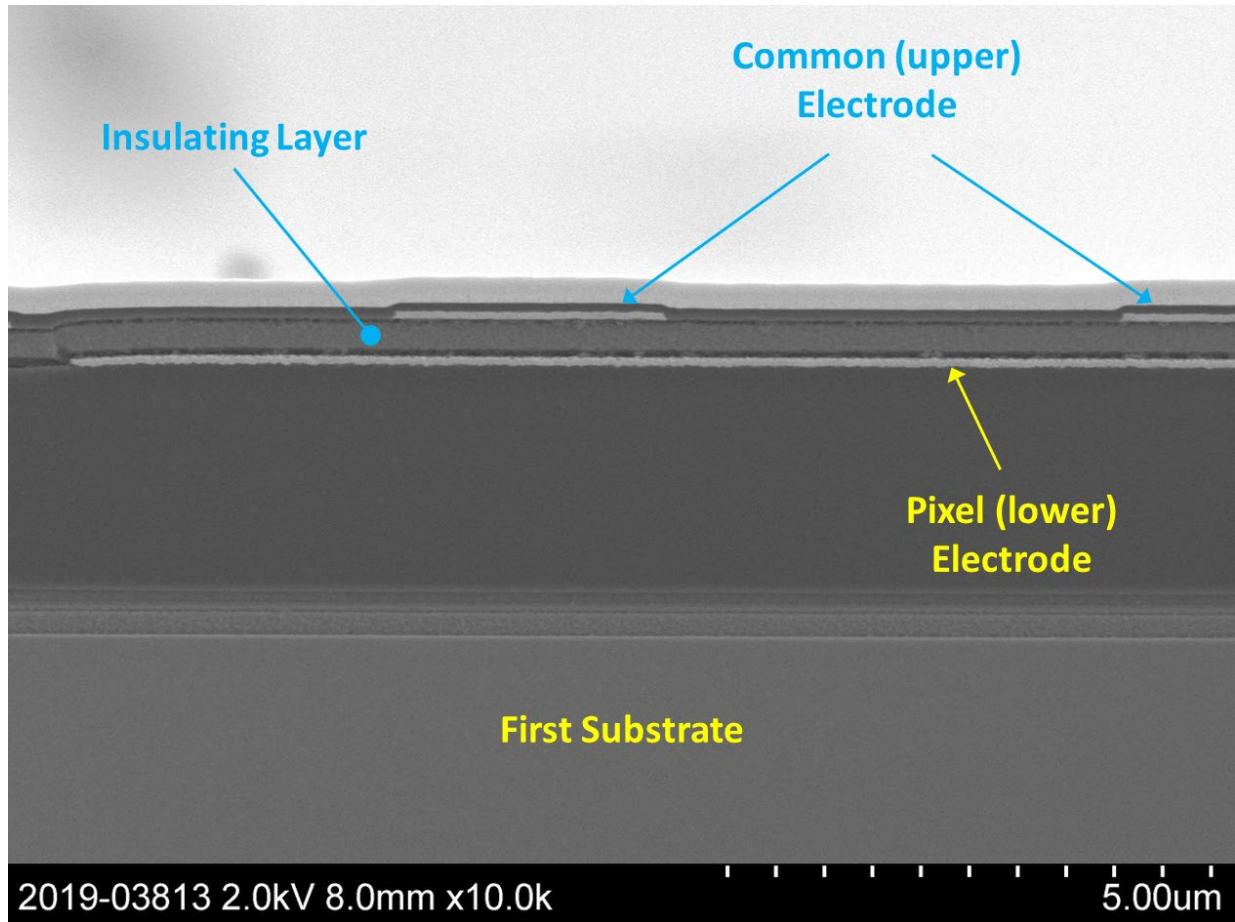

84. BOE LCD panels and modules, including, for example, the BOE panel in the LG 27-inch 27UK600 monitor, comprise the insulating layer described *supra*, that insulating layer comprising slits formed on the upper electrode layer for applying voltage between the upper electrode layer and the lower electrode layer and for driving liquid crystal molecules:

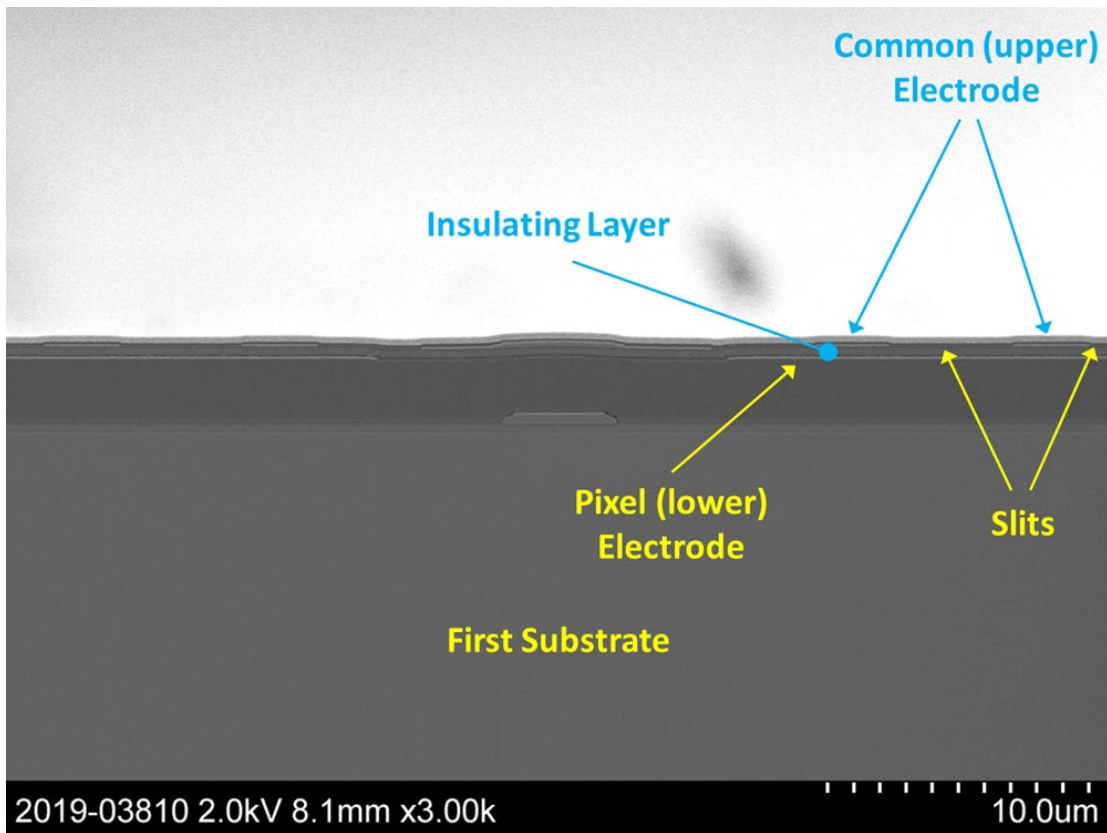
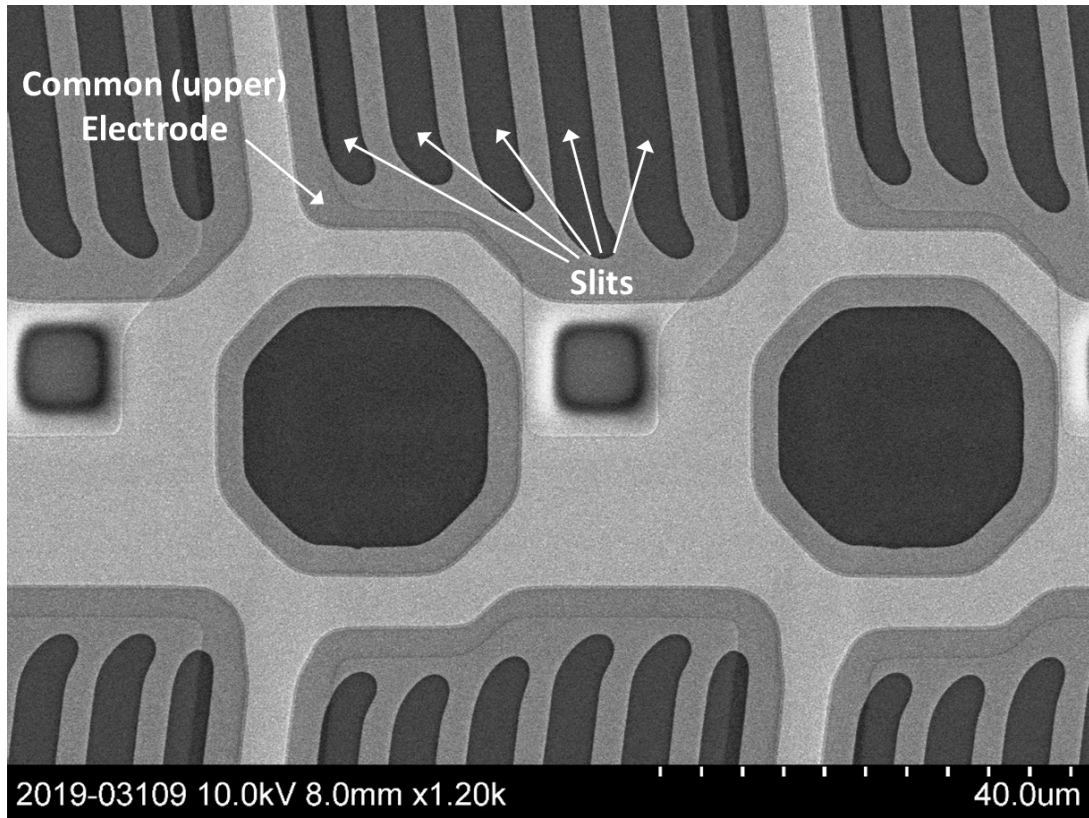

85. BOE LCD panels and modules, including, for example, the BOE panel in the LG 27-inch 27UK600 monitor, comprise a rubbing direction that runs north-south—along direction (b):

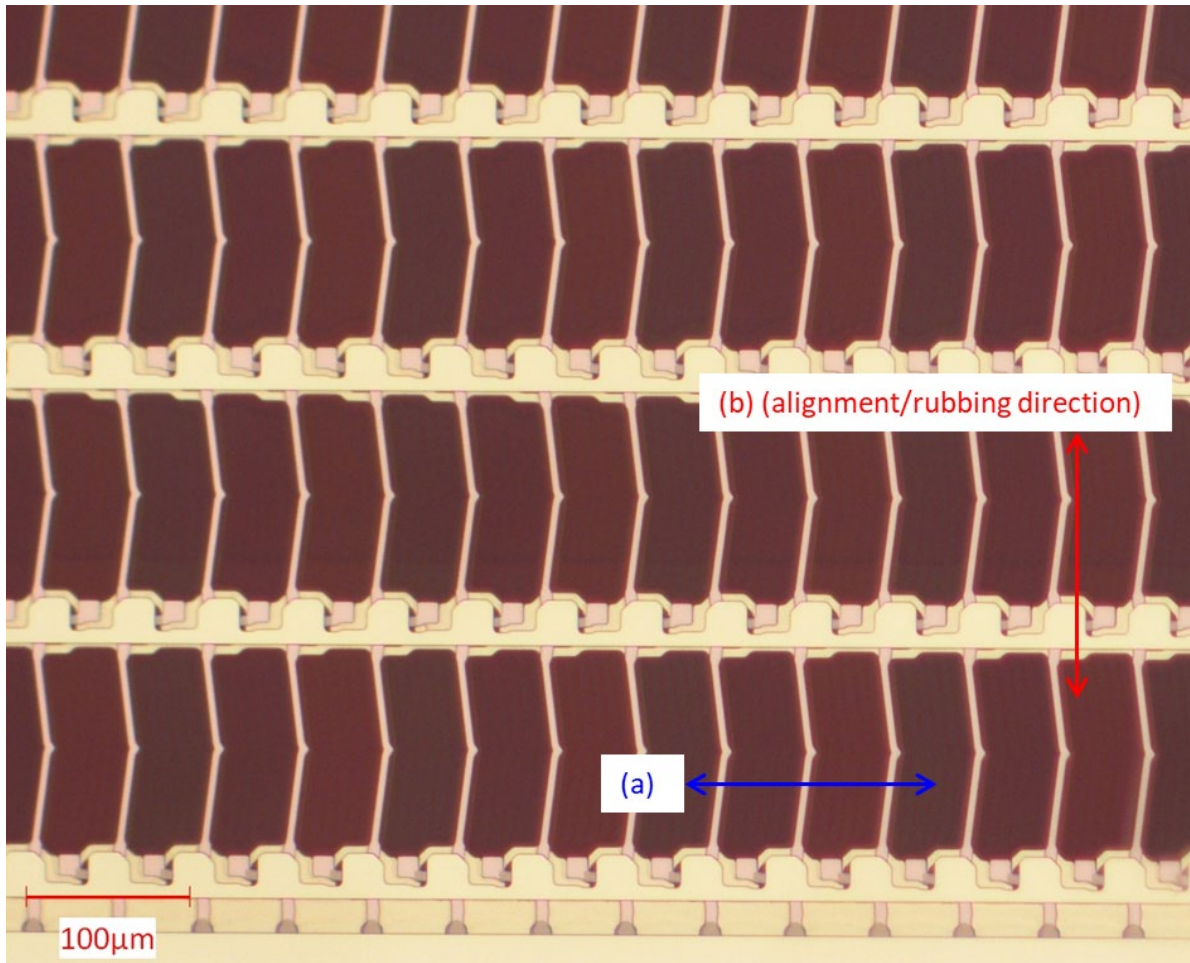

86. Aligning the molecules in this way—in the plane of the substrate and roughly parallel to the slits—is well-known in the FFS art, as shown in the red boxed portion of the Figure at ¶ 82, *supra*, because it allows the LCD molecules to be rotated in a direction orthogonal to the slits when an electric field is activated between the pixel electrode and common electrode, as shown in (d) (“FFS mode”) in that figure.

87. Reverse engineering of the BOE panel in the LG 27-inch 27UK600 monitor

further shows that the rubbing direction is the north-south line in the image immediately above. When placed between two orthogonal polarizers and against a backlight, the polarized LCD panel will appear yellower when viewed perpendicular to the rubbing direction and at an angle of roughly 30 degrees relative to the plane of the panel; the panel will appear bluer when viewed along the rubbing direction and at an angle of roughly 30 degrees relative to the plane of the panel. As shown below, the BOE panel appears bluer when viewed along direction (b), confirming that (b) is the rubbing direction.

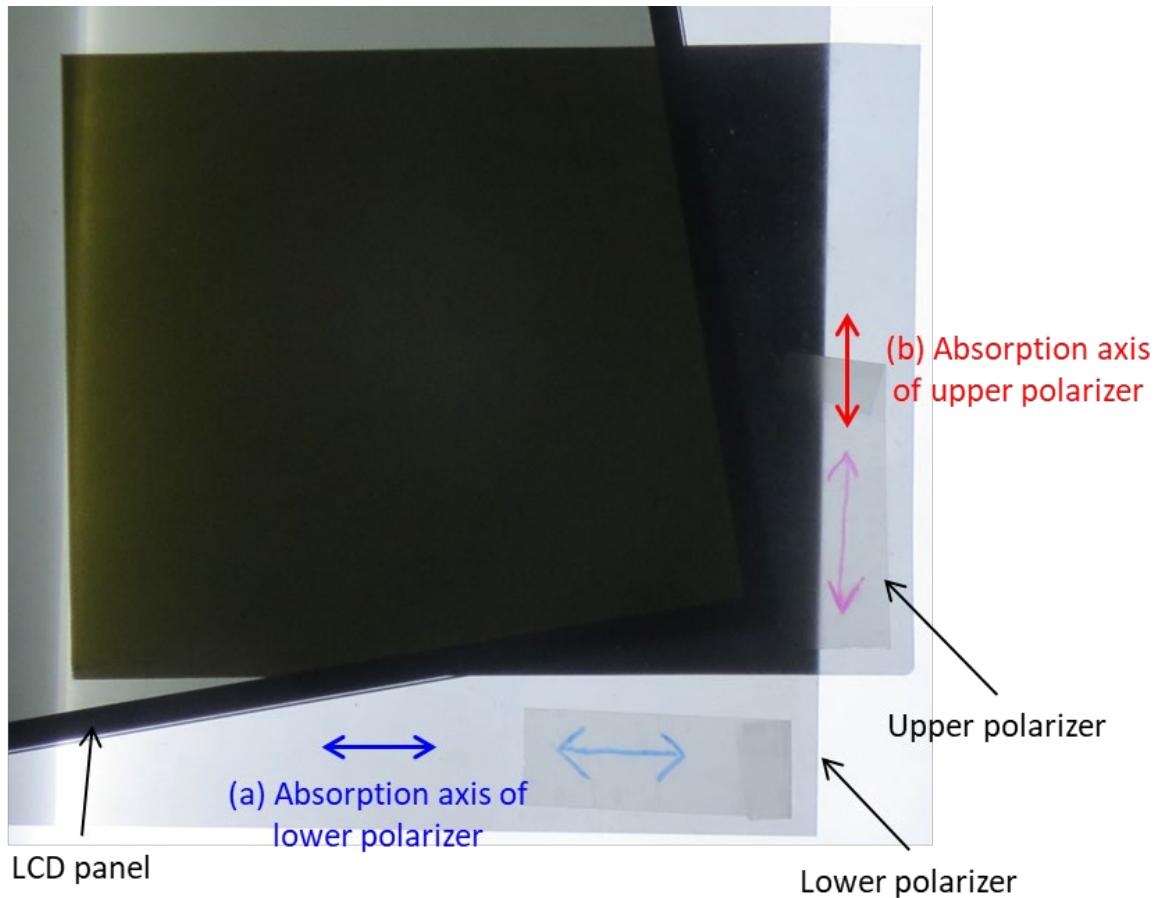

88. As shown below, the light shifts toward yellow when the panel is shifted along the (a) direction, indicating that this is not the rubbing direction:

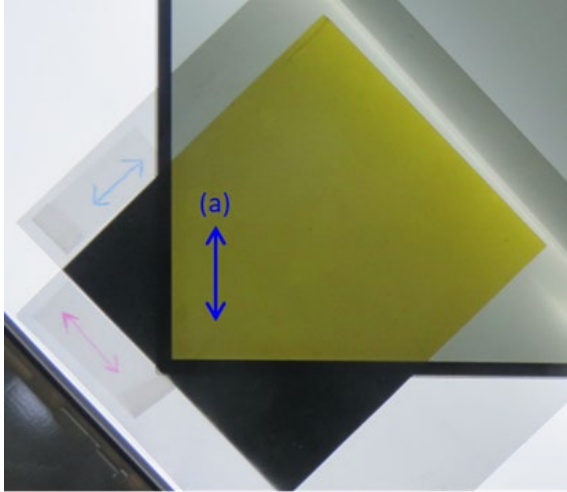

(1) Front view

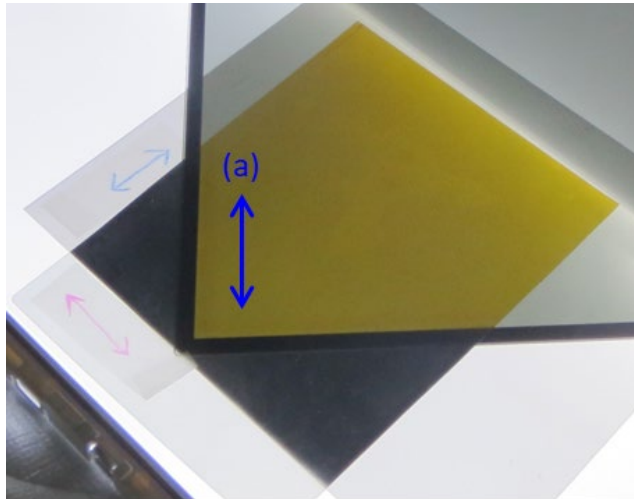

(2) Oblique direction

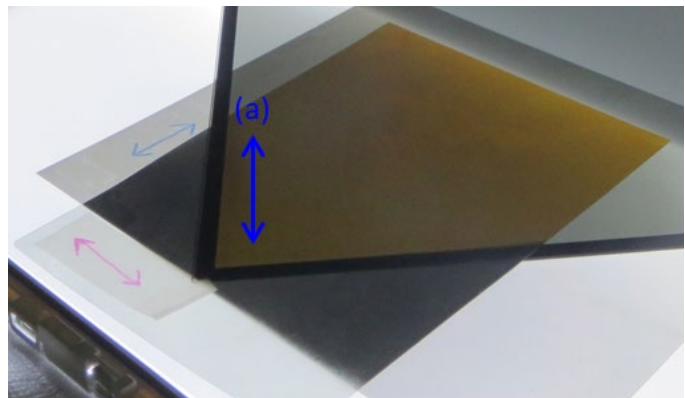

(3) Oblique direction

89. As shown below, the light shifts toward blue when the panel is shifted along the (b) direction, indicating that this is the rubbing direction:

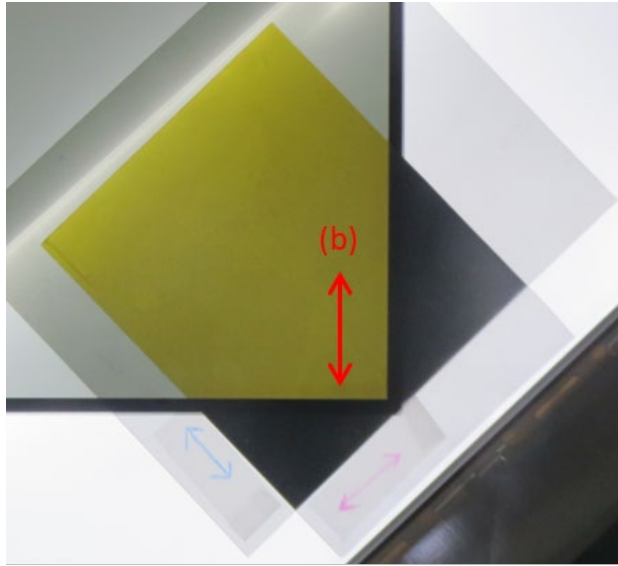

(1) Front view

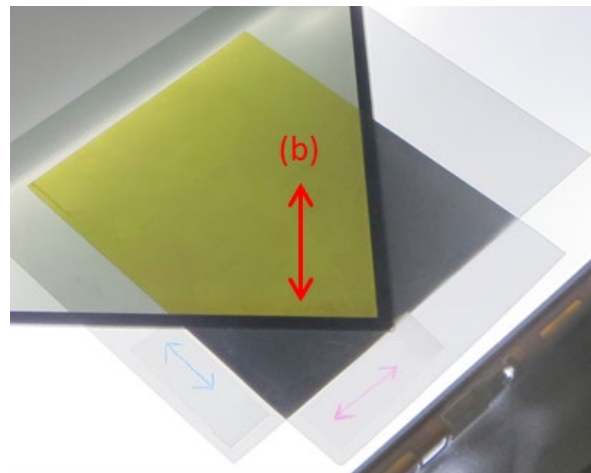

(2) Oblique direction

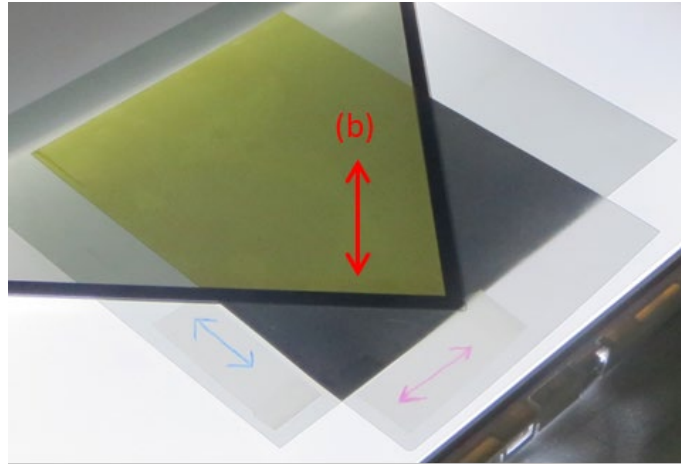

(3) Oblique direction

90. On information and belief, BOE either rubs the TFT substrate to set the alignment direction of the LC molecules, or uses an alternative, equivalent process such as a photoalignment process to set the direction of the LC molecules in the absence of an applied voltage between the pixel and common electrodes.

91. BOE LCD panels and modules, including, for example, the BOE panel in the LG 27-inch 27UK600 monitor, comprise edge portions of the slits each including a first curved portion the tangential direction of which at the edge portions with respect to a rubbing direction falls within a range from 0° to $+90^\circ$ and a second curved portion the tangential direction of which at the edge portions with respect to the rubbing direction falls within the range from 0° to -90° , where the direction toward an acute angle subtended by the long sides of the slits with respect to the rubbing direction is the positive direction, the second curved portion being smaller than the first curved portion, wherein the second curved portion includes a projecting portion, the projecting portion being located at a distal end of the second curved portion:

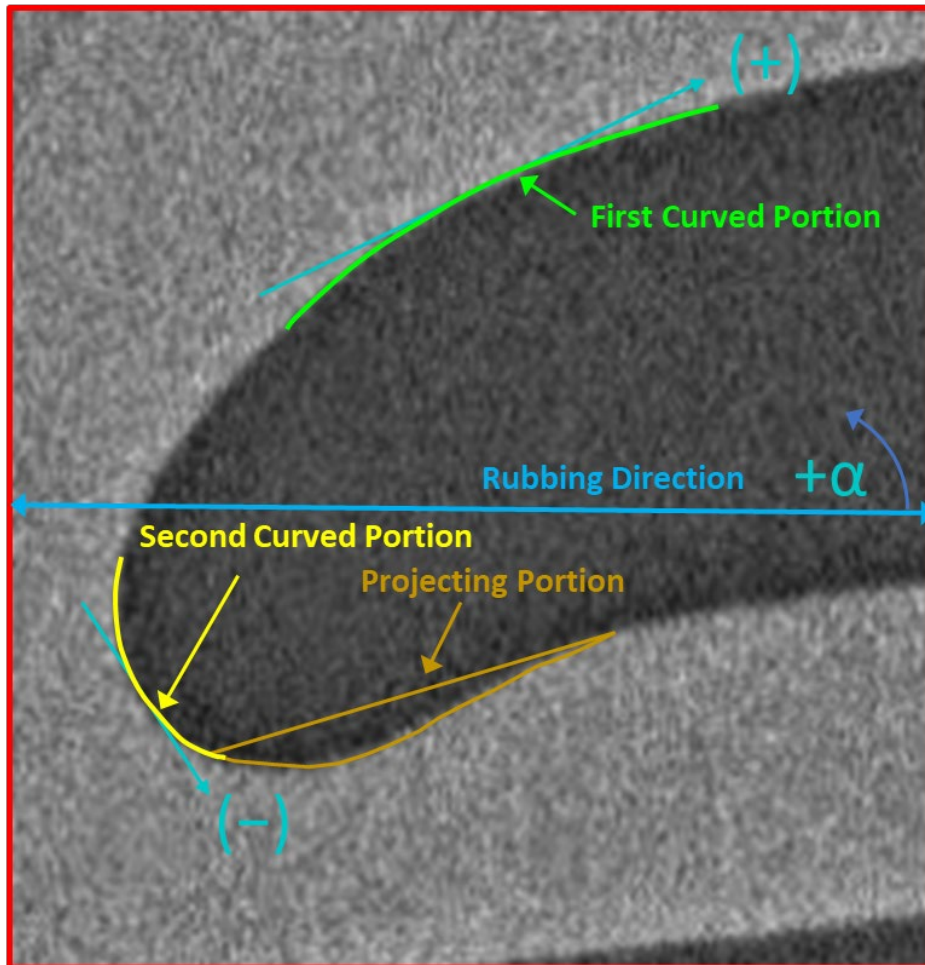
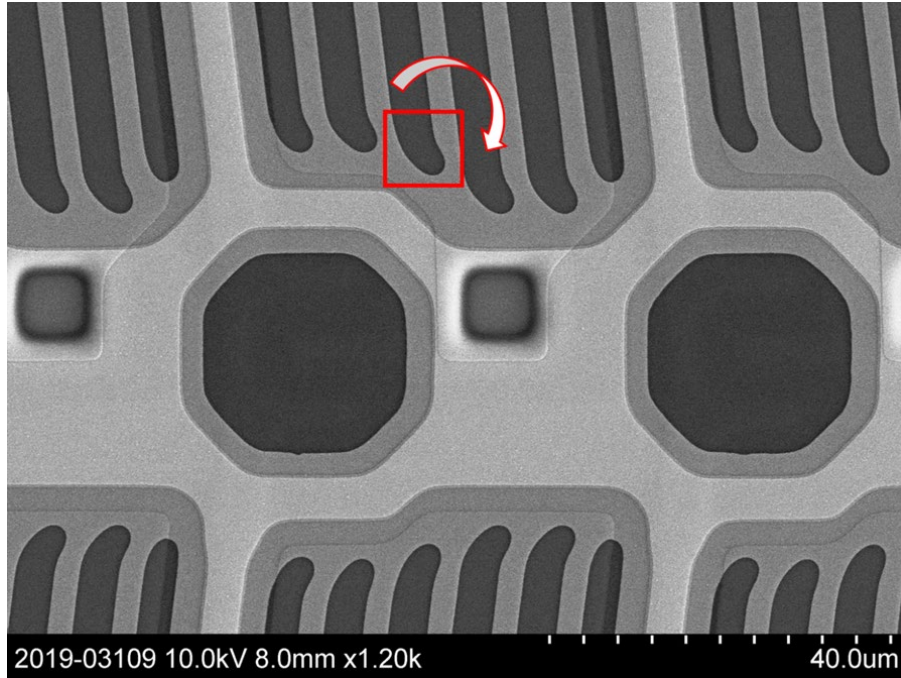

92. As shown in the image immediately above, the projecting portion is located at the distal end of the second curved portion, insofar as the projecting portion extends from the lower right end of the second curved portion. As further shown in the image above, the tangential direction of the first curved portion with respect to the rubbing direction falls within a range from 0° to $+90^\circ$ (“(+)”) and the tangential direction of the second curved portion with respect to the rubbing direction falls within a range from 0° to -90° (“(-)”).

93. BOE has indirectly infringed and continues to indirectly infringe the ’948 patent by actively inducing, in violation of 35 U.S.C. § 271(b), the direct infringement of the ’948 patent by others in the United States, the State of Texas, and the Eastern District of Texas.

94. BOE has induced, and continues to induce, through affirmative acts, its customers and other third parties, including other importers, resellers, and end users in BOE’s supply chain, to directly infringe the ’948 patent by using, offering to sell, selling within the United States, and/or importing into the United States Accused Instrumentalities that infringe the ’948 patent.

95. On information and belief, BOE actively promoted the Accused Instrumentalities for the U.S. market, as alleged here.

96. BOE knew that its customers would offer to sell and/or sell infringing Accused Instrumentalities in the United States or cause Accused Instrumentalities to be sold in the United States, and BOE specifically intended its customers to purchase those

Accused Instrumentalities from BOE and offer to sell and/or sell the Accused Instrumentalities in the United States or cause Accused Instrumentalities to be sold in the United States. BOE's direct and indirect purchasers directly infringe the '948 patent by importing such Accused Instrumentalities into the United States, selling such Accused Instrumentalities in the United States, offering to sell such Accused Instrumentalities in the United States, and using such Accused Instrumentalities in the United States.

97. BOE has induced others' direct infringement despite actual notice that the Accused Instrumentalities infringe the '948 patent. As of at least January 2, 2020, BOE knew that the induced conduct would constitute infringement—and intended that infringement at the time of committing the aforementioned affirmative acts, such that the acts and conduct have been and continue to be committed with the specific intent to induce infringement—or deliberately avoided learning of the infringing circumstances at the time of committing these acts so as to be willfully blind to the infringement that was induced.

98. BOE's direct and indirect infringement of the '948 patent is ongoing.

99. The above-described acts of infringement have caused and continue to cause injury and damage to Longitude.

100. BOE's infringement has been and continues to be willful.

101. Longitude is entitled to recover damages sustained as a result of BOE's willful infringement in an amount subject to proof at trial, but in no event less than a reasonable royalty.

COUNT III: INFRINGEMENT OF U.S. PATENT NO. 8,223,093

102. Pursuant to 35 U.S.C. § 282, the '093 patent is presumed valid.

103. BOE has directly infringed and continues to directly infringe one or more claims of the '093 patent, in violation of 35 U.S.C. § 271(a).

104. The Accused Instrumentalities directly infringe at least claim 1 of the '093 patent.

105. Paragraphs 107-116 describe the manner in which the Accused Instrumentalities infringe claim 1 of the '093 patent, by way of the exemplary BOE LCD panel in the LG 55-inch 55UP7670PUC TV. Longitude's allegations of infringement are not limited to claim 1 or the exemplary product, and additional infringement will be identified and disclosed through discovery and in infringement contentions.

106. The panel in the LG 55-inch 55UP7670PUC TV is a BOE panel, as indicated by the "BOE" logo on the printed circuit board:

LG 55" UP7670PUC



LG 55" UP7670PUC, LCD Layer (front)

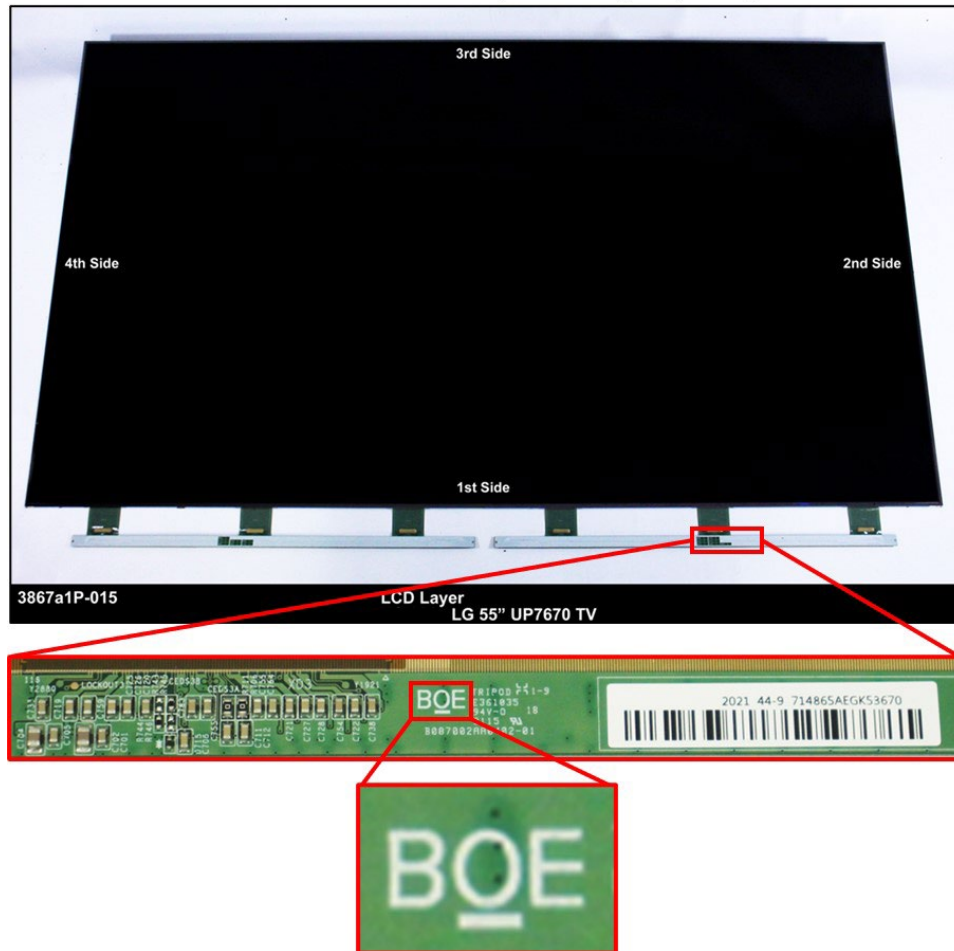

107. BOE display panels and modules, including, for example, the LCD panel used in the LG 55UP7670PUC TV, are electro-optical devices comprising an element substrate. The devices comprise an element substrate on which the pixels are arranged at the intersections of data lines and scanning lines on the element substrate:

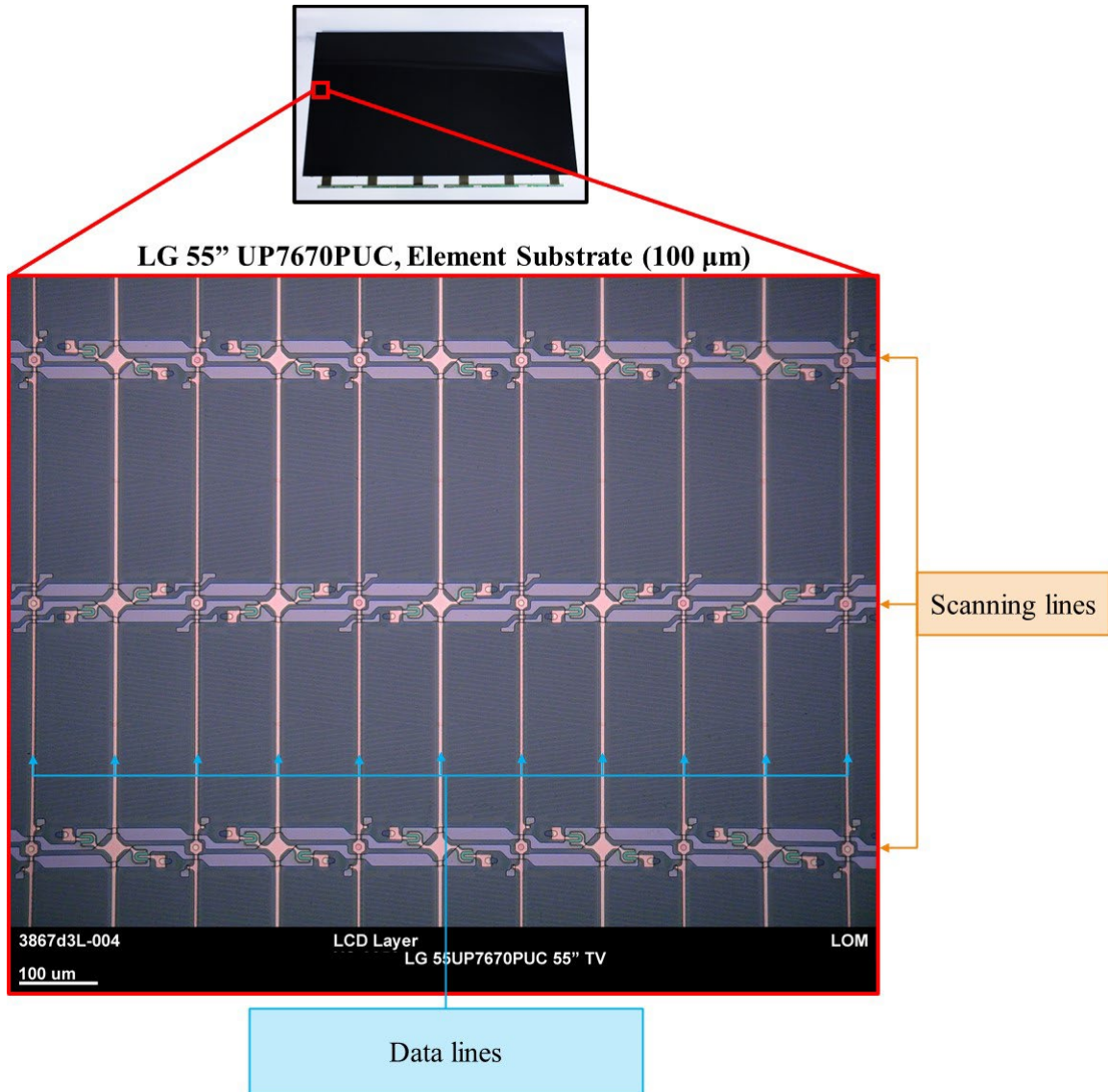

108. BOE panels and modules, including, for example, the LCD panel used in the LG 55UP7670PUC TV, are electro-optical devices comprising an element substrate having a first signal line extending in a first direction:

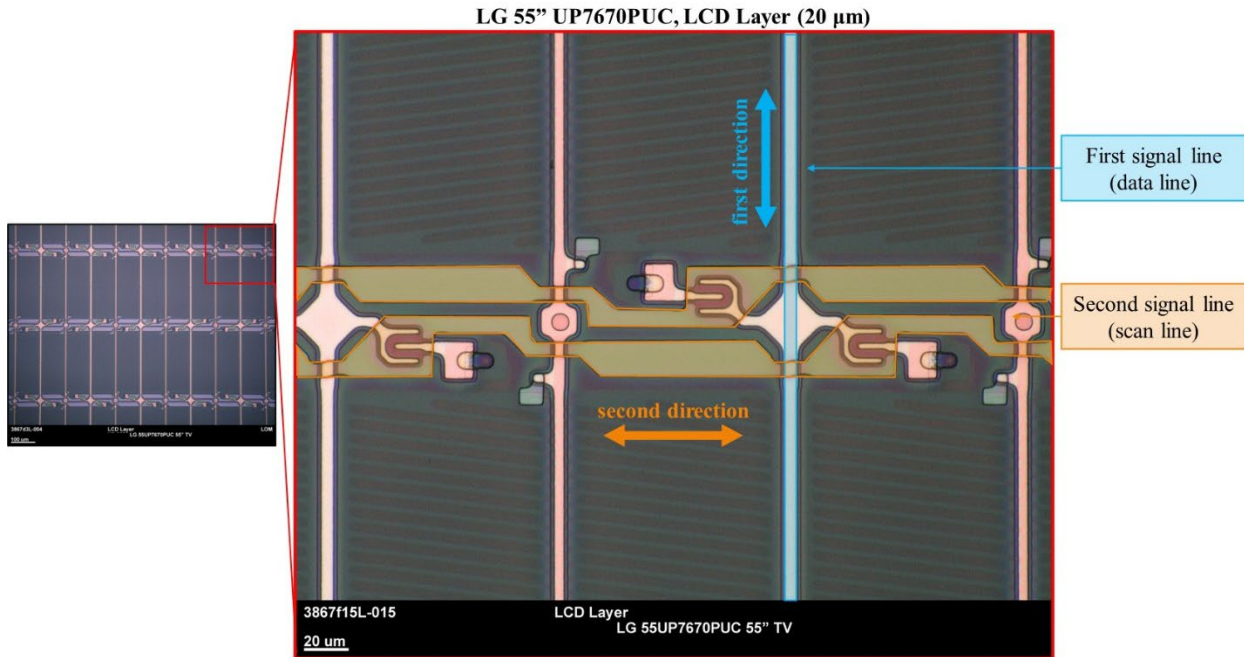

109. BOE display panels and modules, including, for example, the LCD panel used in the LG 55UP7670PUC TV, are electro-optical devices comprising an element substrate having a second signal line extending in a second direction crossing the first direction:

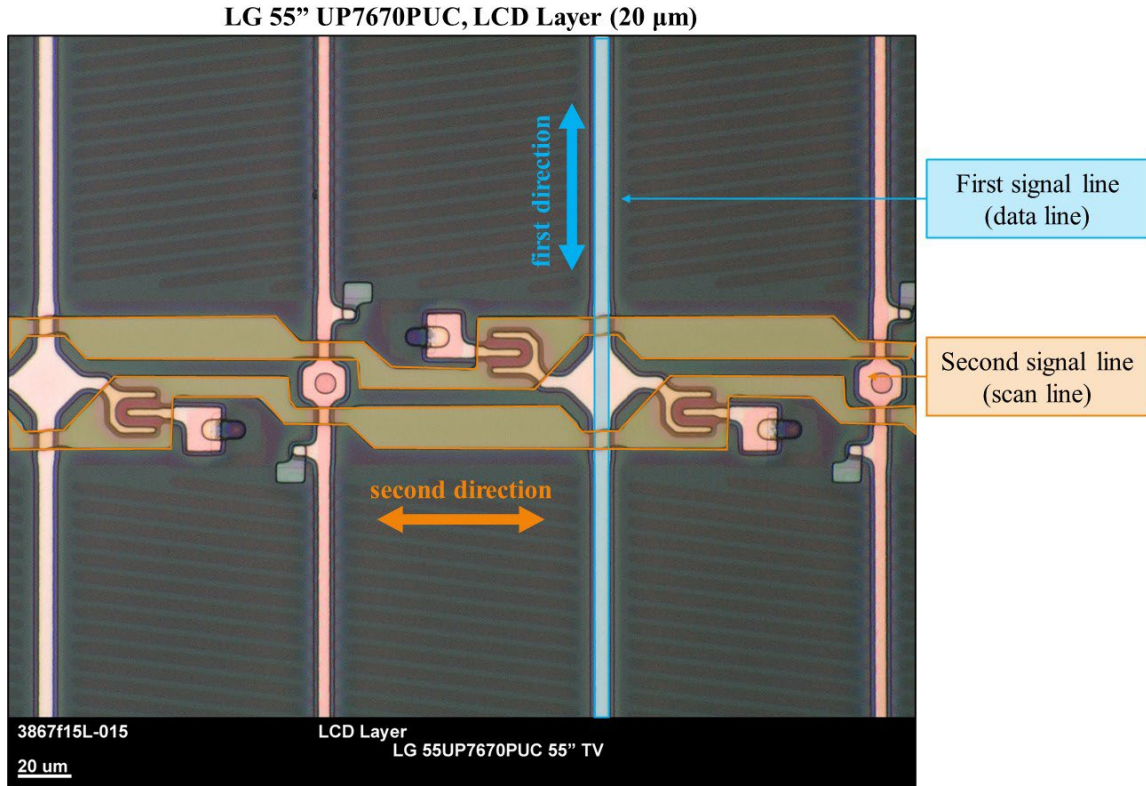

110. BOE display panels and modules, including, for example, the LCD panel used in the LG 55UP7670PUC TV, are electro-optical devices comprising an element substrate having a first pixel electrode electrically connected to the first signal line:

LG 55" UP7670PUC, LCD Layer (20 μm)

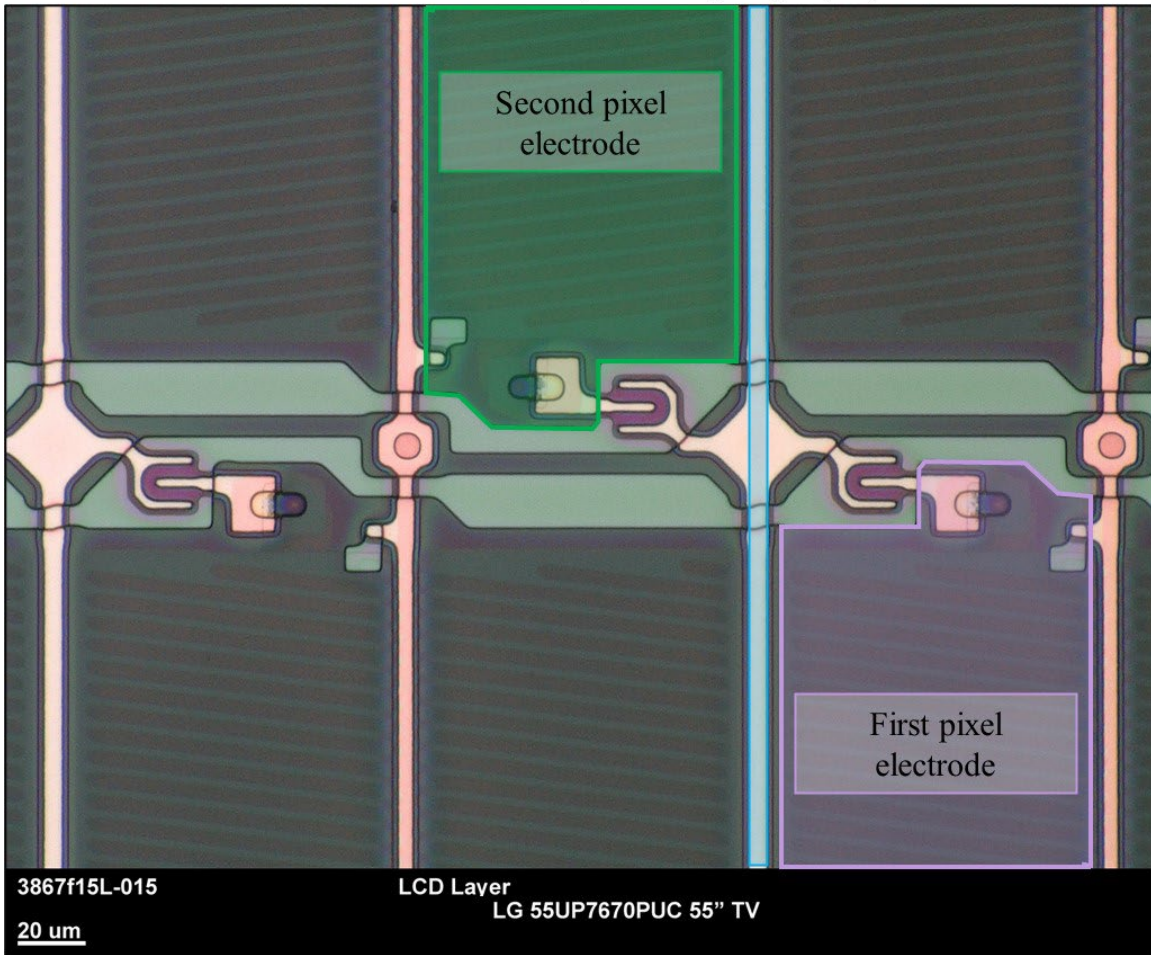

LG 55" UP7670PUC, LCD Layer (20 μm)

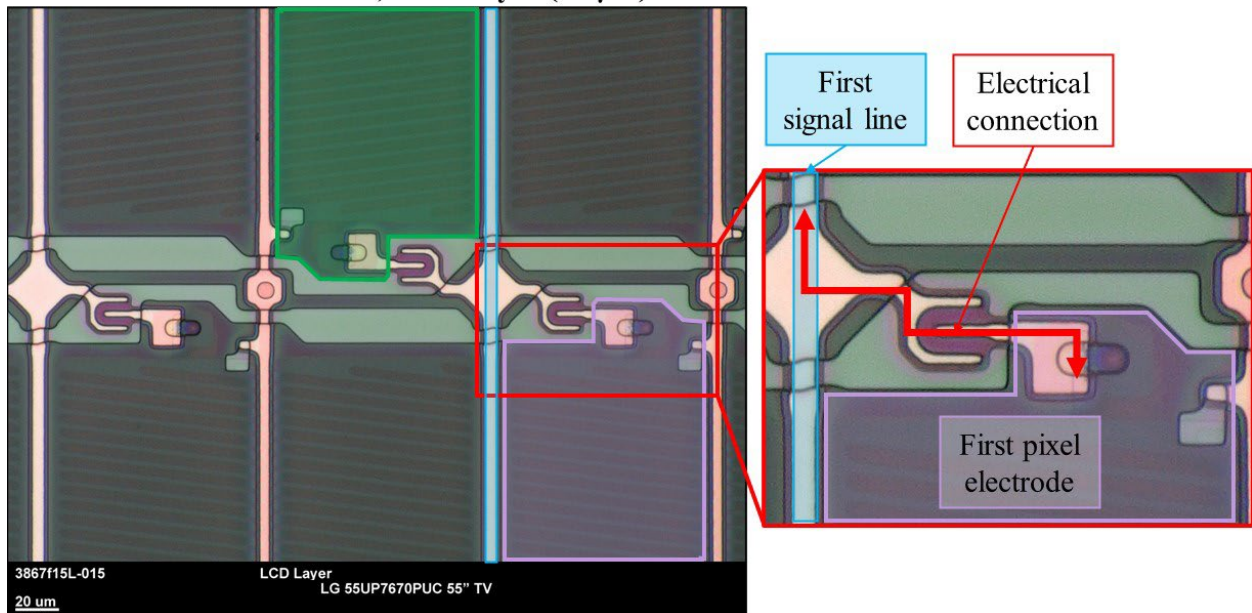

111. BOE display panels and modules, including, for example, the LCD panel used in the LG 55UP7670PUC TV, are electro-optical devices comprising an element substrate having a second pixel electrode electrically connected to the first signal line and adjacent to the first pixel electrode:

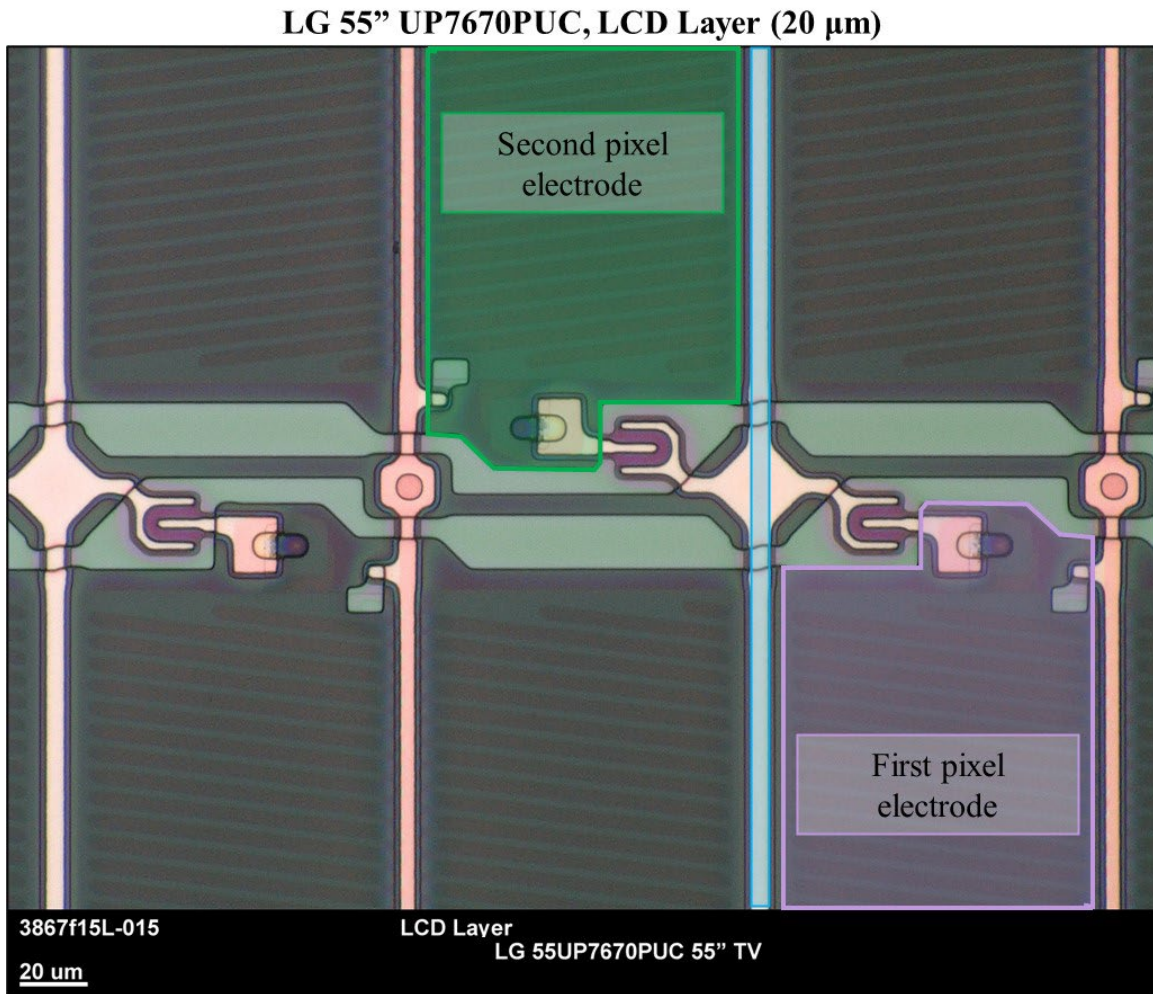

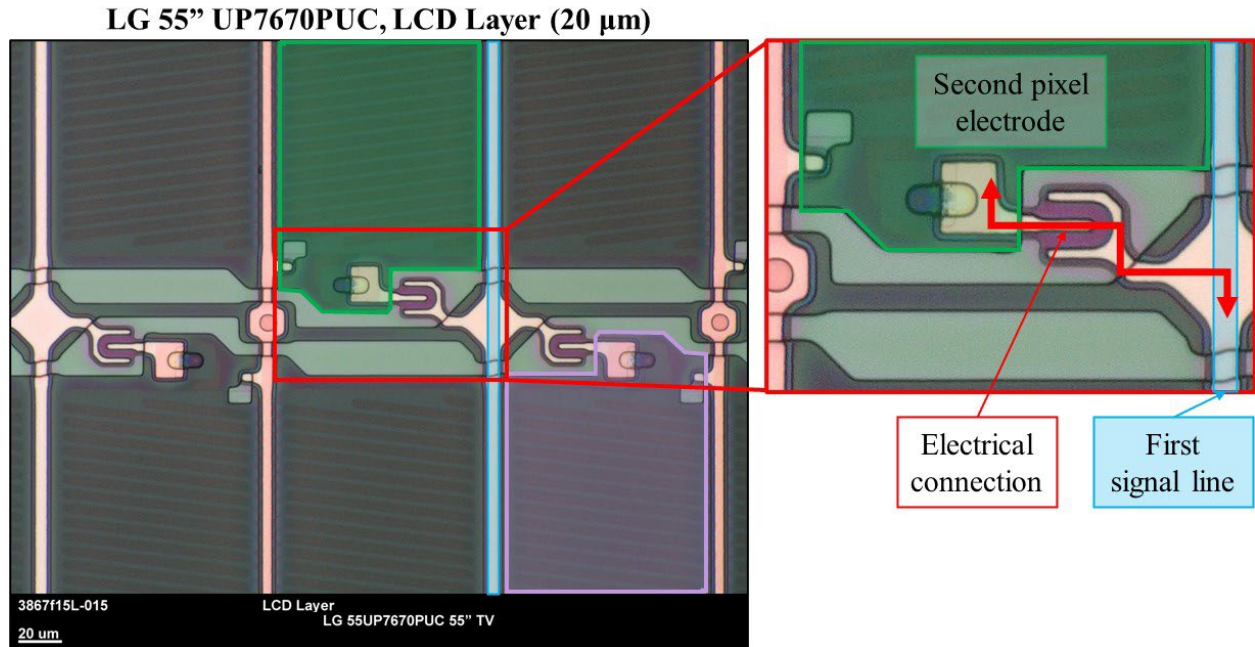

112. BOE display panels and modules, including, for example, the LCD panel used in the LG 55UP7670PUC TV, are electro-optical devices comprising an element substrate having a first field-effect transistor electrically connecting the first pixel electrode to the first signal line, and a second field-effect transistor electrically connecting the second pixel electrode to the first signal line, wherein the first field-effect transistor includes a first semiconductor layer extending in a direction crossing the second direction. The devices comprise an element substrate having a first field-effect transistor electrically connecting the first pixel electrode to the first signal line and a second field-effect transistor electrically connecting the second pixel electrode to the first signal line:

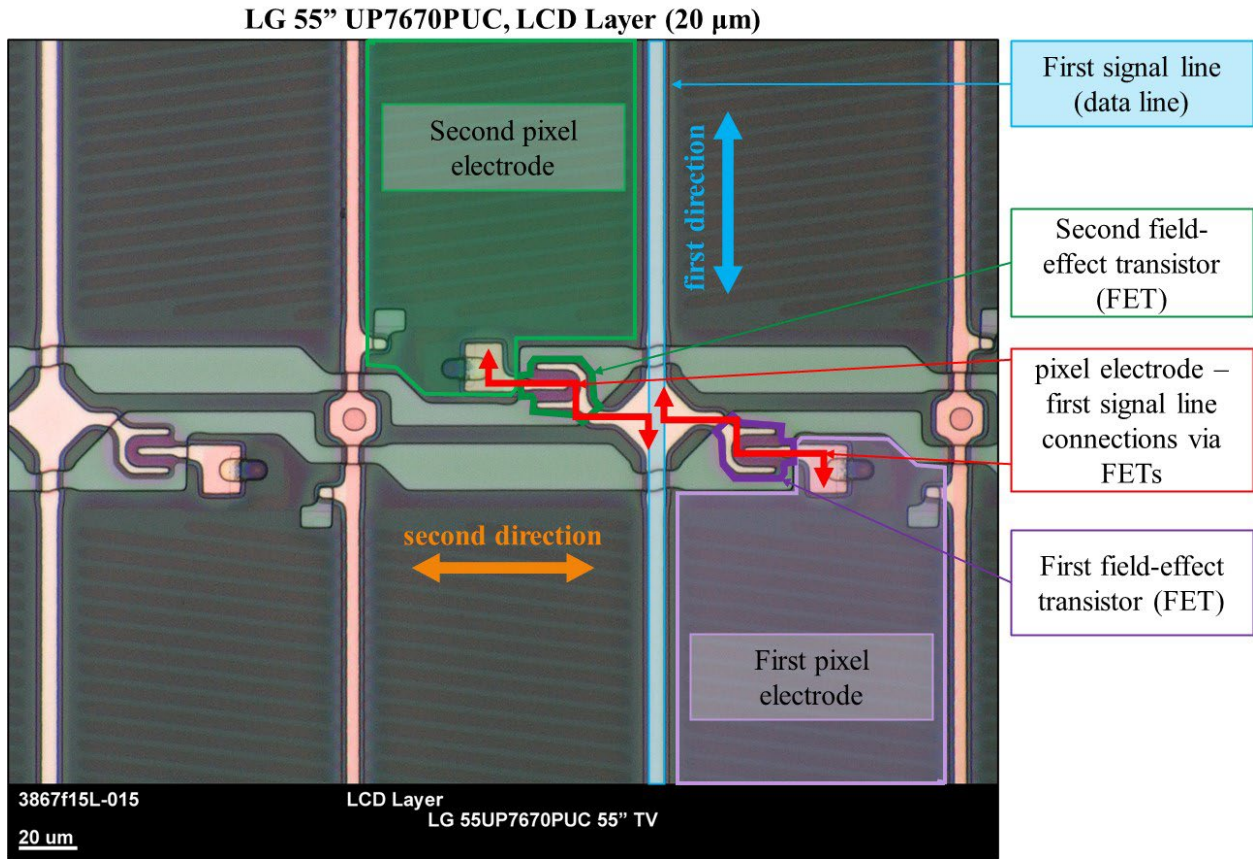

113. The devices comprise an element substrate wherein the first field-effect transistor includes a first semiconductor layer extending in a direction crossing the second direction:

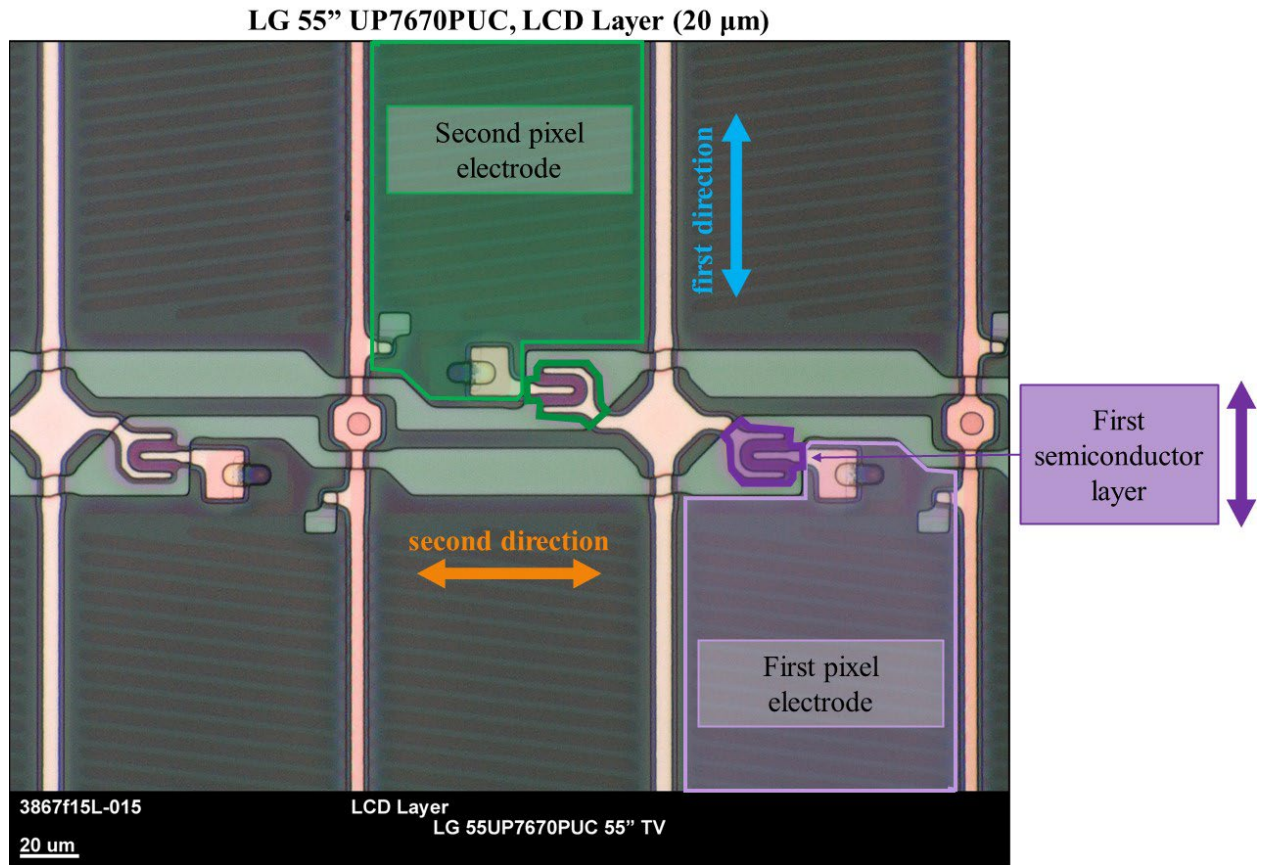

114. BOE panels and modules, including, for example, the LCD panel used in the LG 55UP7670PUC TV, are electro-optical devices comprising an element substrate wherein the second field-effect transistor includes a second semiconductor layer extending in the direction crossing the second direction:

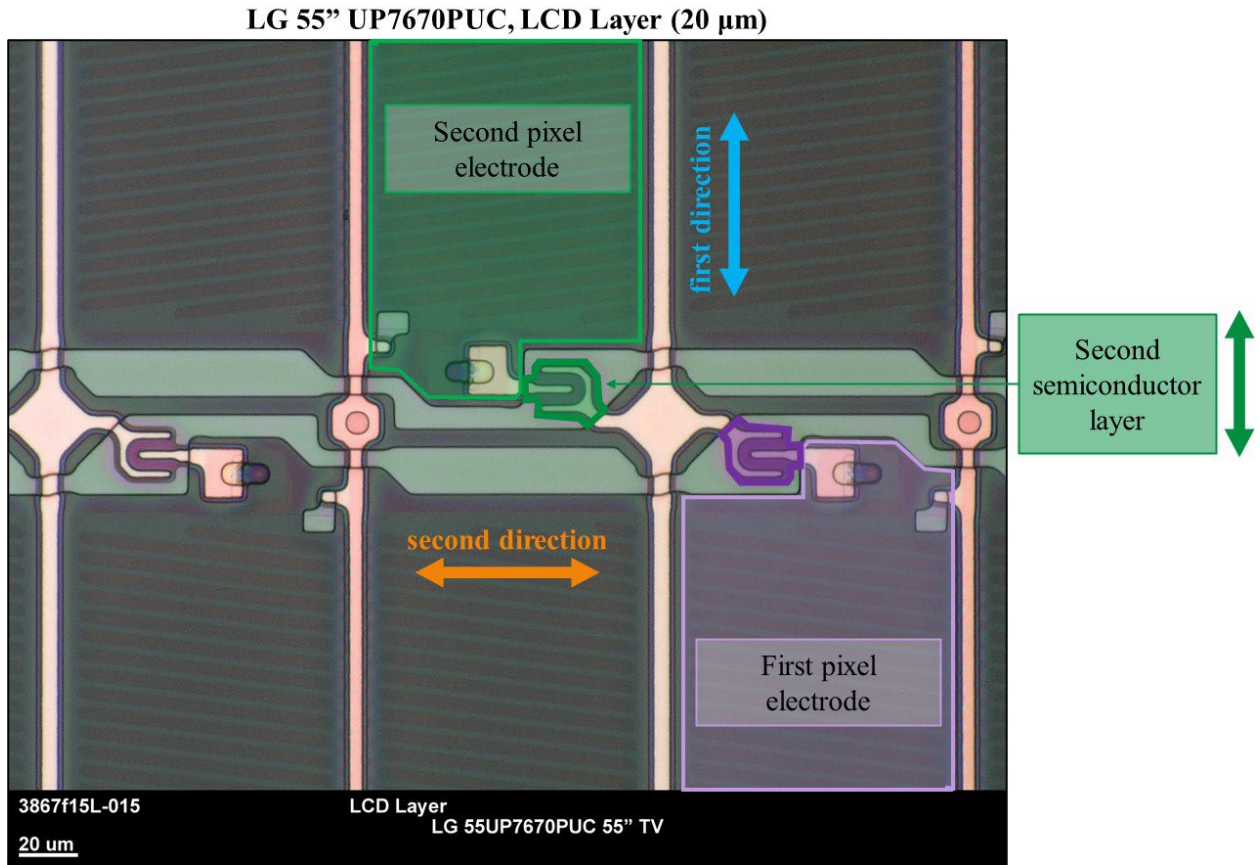

115. BOE panels and modules, including, for example, the LCD panel used in the LG 55UP7670PUC TV, are electro-optical devices comprising an element substrate wherein the first semiconductor layer and the second semiconductor layer are displaced from each other in the second direction:

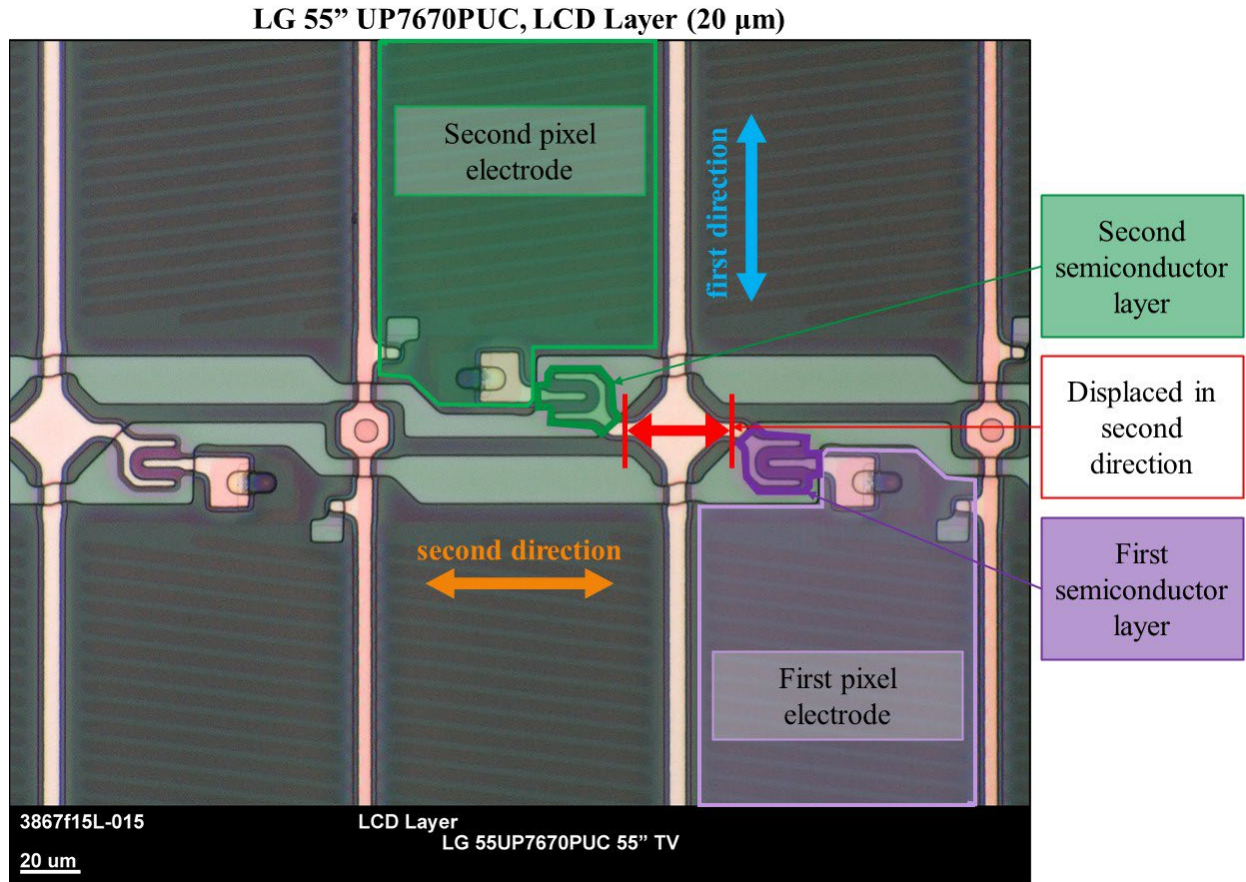

116. BOE panels and modules, including, for example, the LCD panel used in the LG 55UP7670PUC TV, are electro-optical devices comprising an element substrate wherein an end of the first semiconductor layer facing toward the second pixel electrode is adjacent to an end of the second semiconductor layer facing toward the first pixel electrode or is closer to the second pixel electrode than the end of the second semiconductor layer facing toward the first pixel electrode. The devices comprise an element substrate wherein an end of the first semiconductor layer facing toward the second pixel electrode is adjacent to an end of the second semiconductor layer facing toward the first pixel electrode:

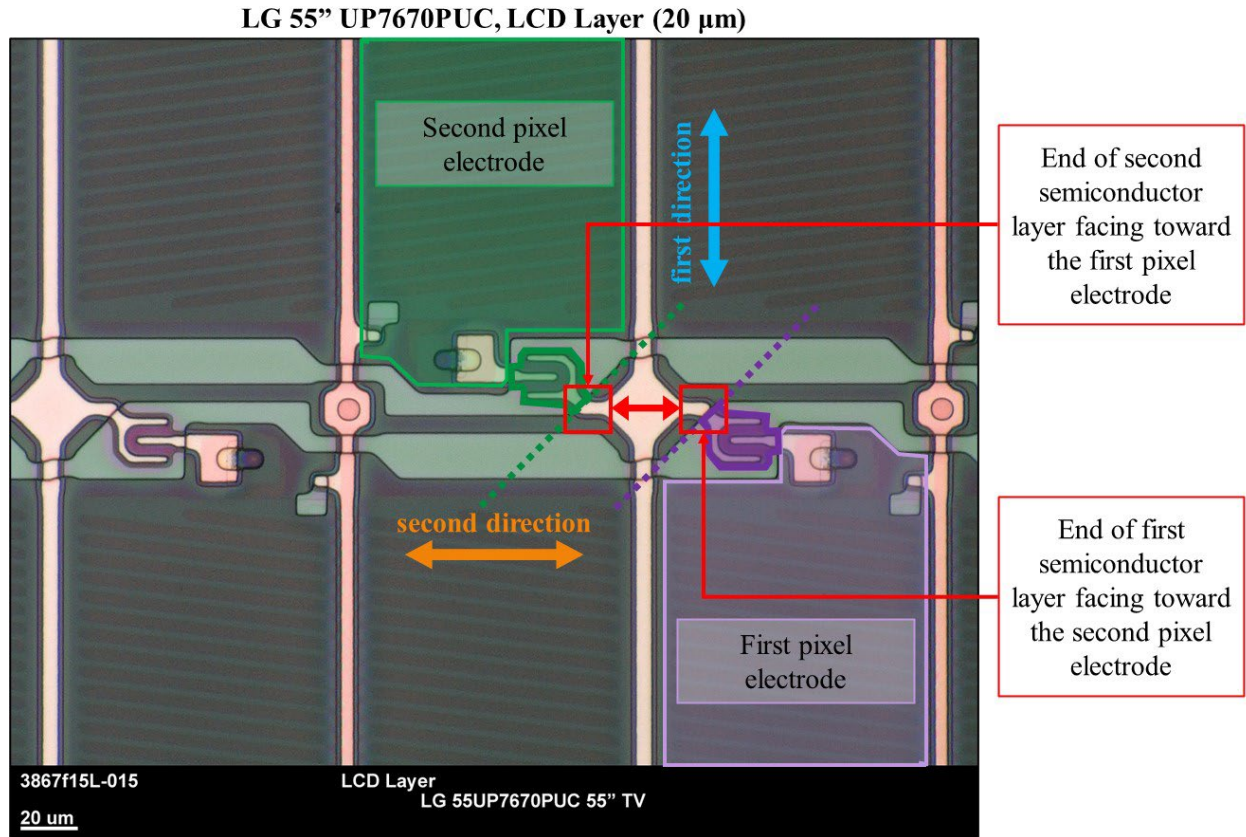

117. BOE has indirectly infringed and continues to indirectly infringe the '093 patent by actively inducing, in violation of 35 U.S.C. § 271(b), the direct infringement of the '093 patent by others in the United States, the State of Texas, and the Eastern District of Texas.

118. BOE has induced, and continues to induce, through affirmative acts, its customers and other third parties, including other importers, resellers, and end users in BOE's supply chain, to directly infringe the '093 patent by making, using, offering to sell, selling within the United States, and/or importing into the United States Accused Instrumentalities that infringe the '093 patent.

119. On information and belief, BOE actively promoted the Accused Instrumentalities for the U.S. market, as alleged here.

120. BOE knew that its customers would offer to sell and/or sell infringing Accused Instrumentalities in the United States or cause Accused Instrumentalities to be sold in the United States, and BOE specifically intended its customers to purchase Accused Instrumentalities from BOE and offer to sell and/or sell the Accused Instrumentalities in the United States or cause Accused Instrumentalities to be sold in the United States. BOE's direct and indirect purchasers directly infringe the '093 patent by importing such Accused Instrumentalities into the United States, selling such Accused Instrumentalities in the United States, offering to sell such Accused Instrumentalities in the United States, and/or using such Accused Instrumentalities in the United States.

121. BOE has induced others' direct infringement despite actual notice that the Accused Instrumentalities infringe the '093 patent. As of at least September 28, 2023, BOE knew that the induced conduct would constitute infringement—and intended that infringement at the time of committing the aforementioned affirmative acts, such that the acts and conduct have been and continue to be committed with the specific intent to induce infringement—or deliberately avoided learning of the infringing circumstances at the time of committing these acts so as to be willfully blind to the infringement that was induced.

122. BOE's direct and indirect infringement of the '093 patent is ongoing.

123. The above-described acts of infringement have caused and continue to cause injury and damage to Longitude.

124. BOE's infringement has been and continues to be willful.

125. Longitude is entitled to recover damages sustained as a result of BOE's

willful infringement in an amount subject to proof at trial, but in no event less than a reasonable royalty.

COUNT IV: INFRINGEMENT OF U.S. PATENT NO. 9,184,157

126. Pursuant to 35 U.S.C. § 282, the '157 patent is presumed valid.

127. BOE has directly infringed and continues to directly infringe one or more claims of the '157 patent, in violation of 35 U.S.C. § 271(a).

128. The Accused Instrumentalities directly infringe at least claim 4 of the '157 patent.

129. Paragraphs 131-144 describe the manner in which the Accused Instrumentalities infringe claim 4 of the '157 patent, by way of the exemplary BOE LCD panel in the HP 21kd monitor. Longitude's allegations of infringement are not limited to claim 4 or the exemplary product, and additional infringement will be identified and disclosed through discovery and in infringement contentions.

130. The LCD panel in the HP 21kd monitor is a BOE panel, as indicated by the "BOE" logo on the back of the LCD module and on the panel itself:

HP 21 kd Monitor



HP 21 kd Monitor, LCD Module (back view)

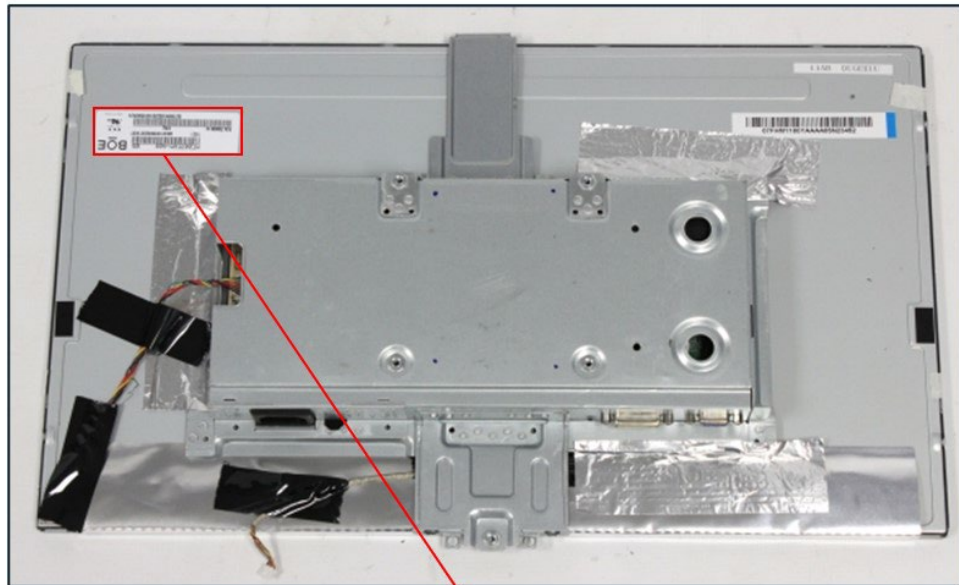

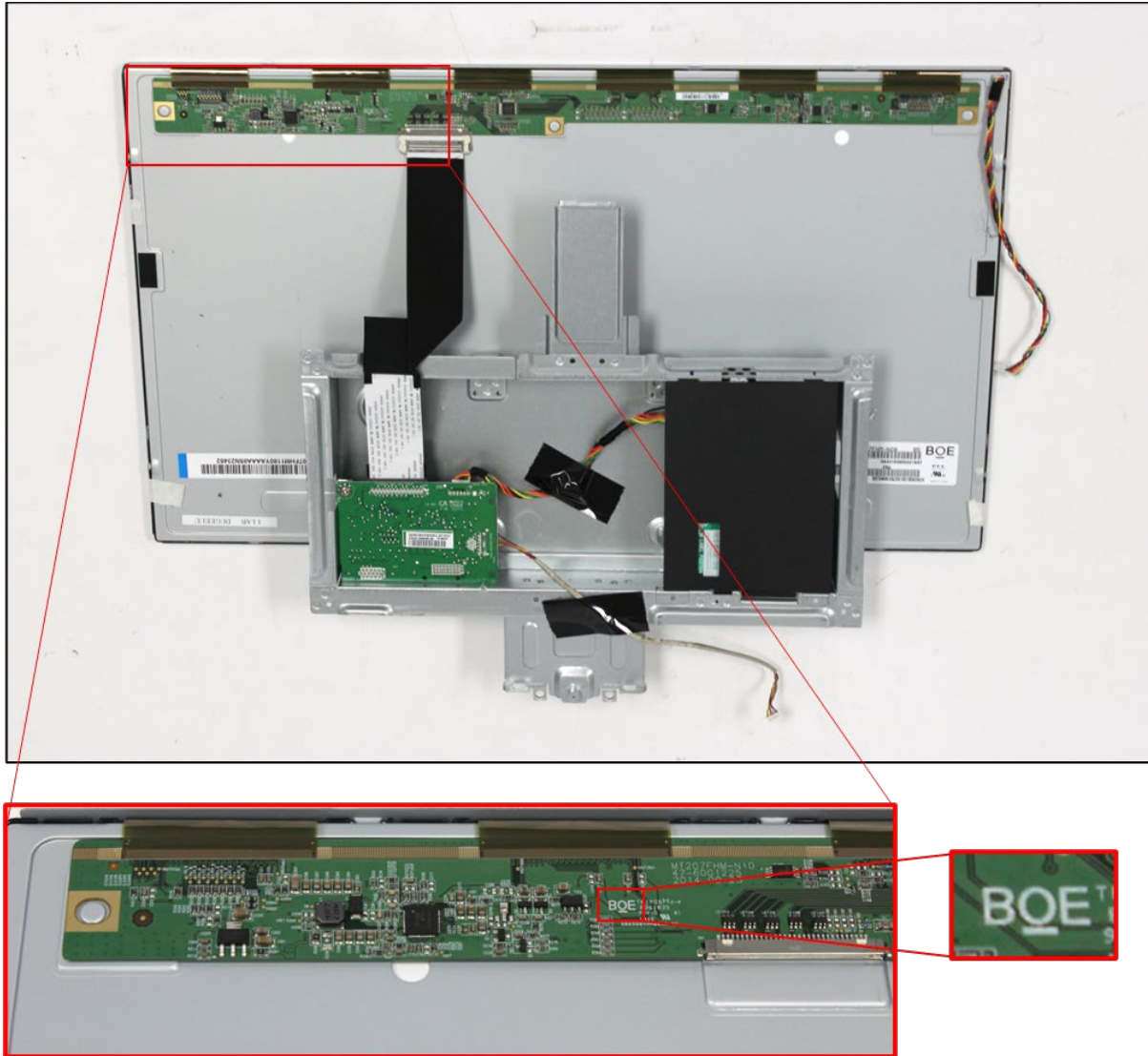

131. BOE display modules and panels, including, for example, the LCD panel used in the HP 21kd monitor, are display devices comprising a scanning line driving circuit:

LOM: LCD Layer, bottom left (2mm)



Scanning line driving circuit

LOM: LCD Layer, bottom left (1mm)

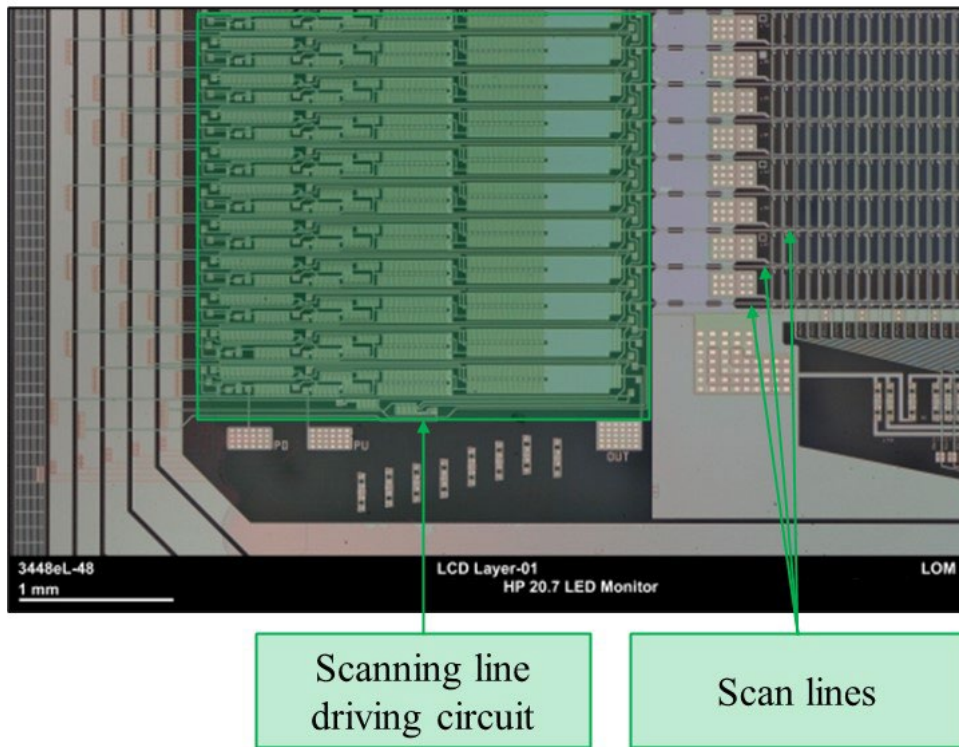

132. BOE display modules and panels, including, for example, the LCD panel used in the HP 21kd monitor, are display devices comprising a power supply line connected to the scanning line driving circuit, the power supply line being one of a low potential power supply line or a high potential power supply line. The BOE LCD panel used in the HP 21kd monitor comprises a power supply line:

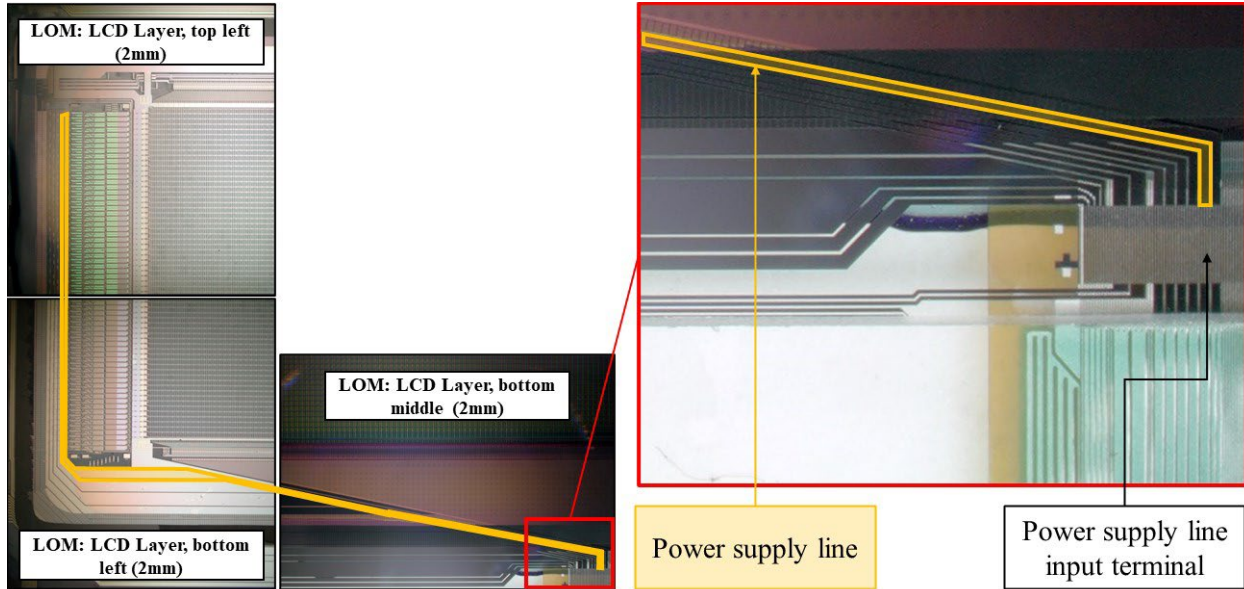

133. The BOE LCD panel used in the HP 21kd monitor comprises a power supply line connected to the scanning line driving circuit:

LOM: LCD Layer, bottom left (1mm)

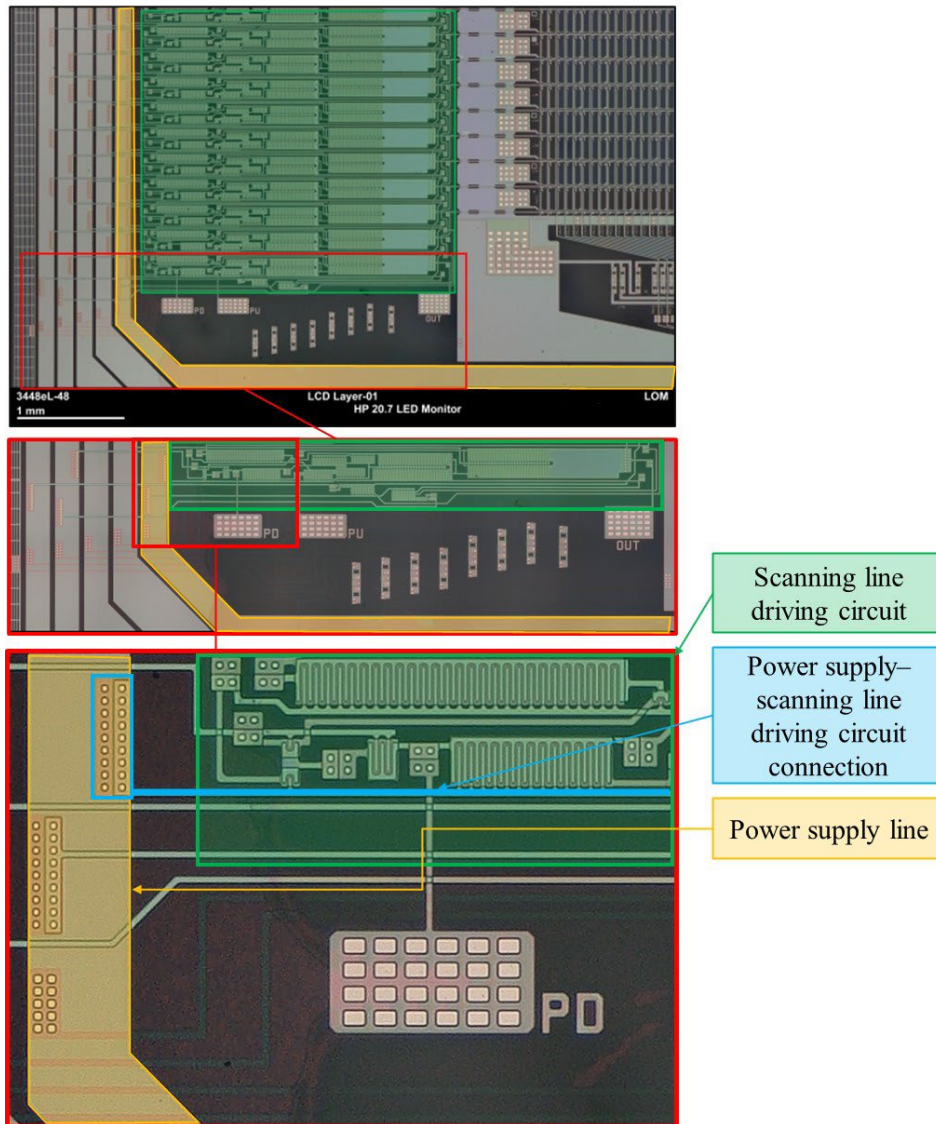

134. On information and belief, the power supply line is a high potential power supply line because it is connected to all the source and drain electrodes, but not the gate electrodes, of the transistors in each shift register unit.

135. BOE display modules and panels, including, for example, the LCD panel used in the HP 21kd monitor, are display devices comprising an input terminal connected to the power supply line to supply power:

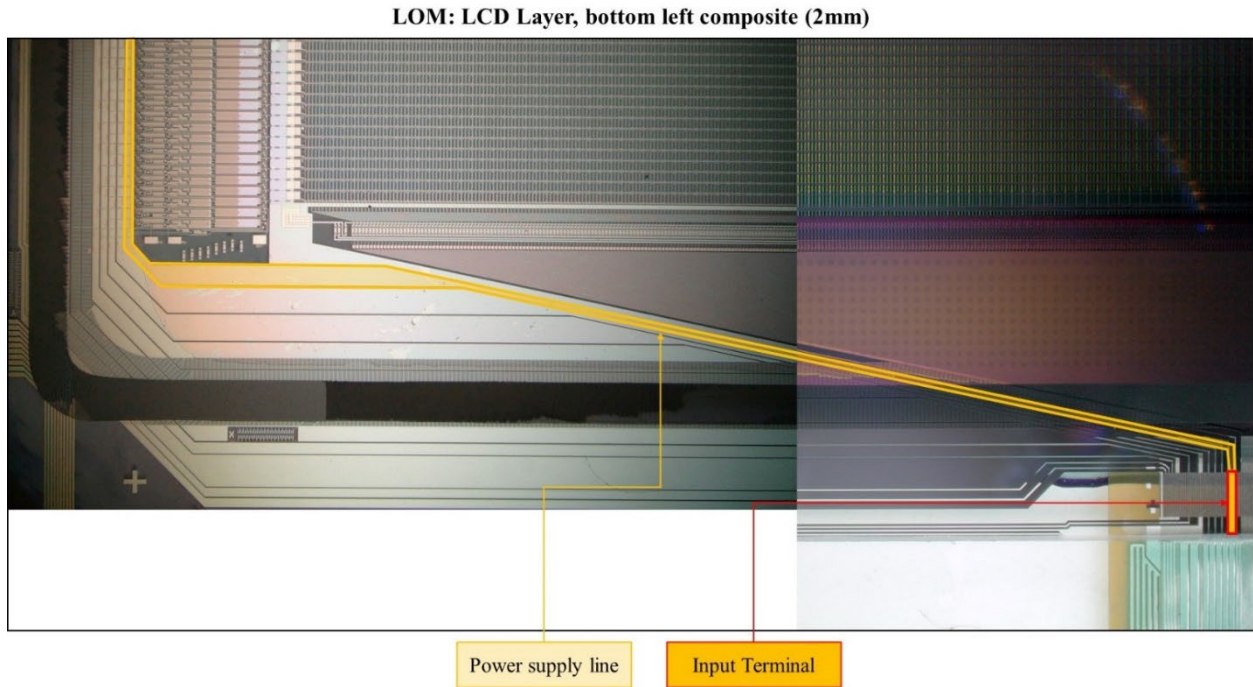

136. BOE display modules and panels, including, for example, the LCD panel used in the HP 21kd monitor, are display devices comprising a first protection circuit and a second protection circuit that are connected to the scanning line driving circuit to protect the scanning line driving circuit, and the first protection circuit and the second protection circuit are connected to the power supply line. The BOE LCD panel used in the HP 21kd monitor includes a first protective circuit and a second protective circuit, each of which is connected to the power supply line, which is connected to the scanning line driving circuit, and the protective circuits are connected to the scanning line driving circuit via the power supply line:

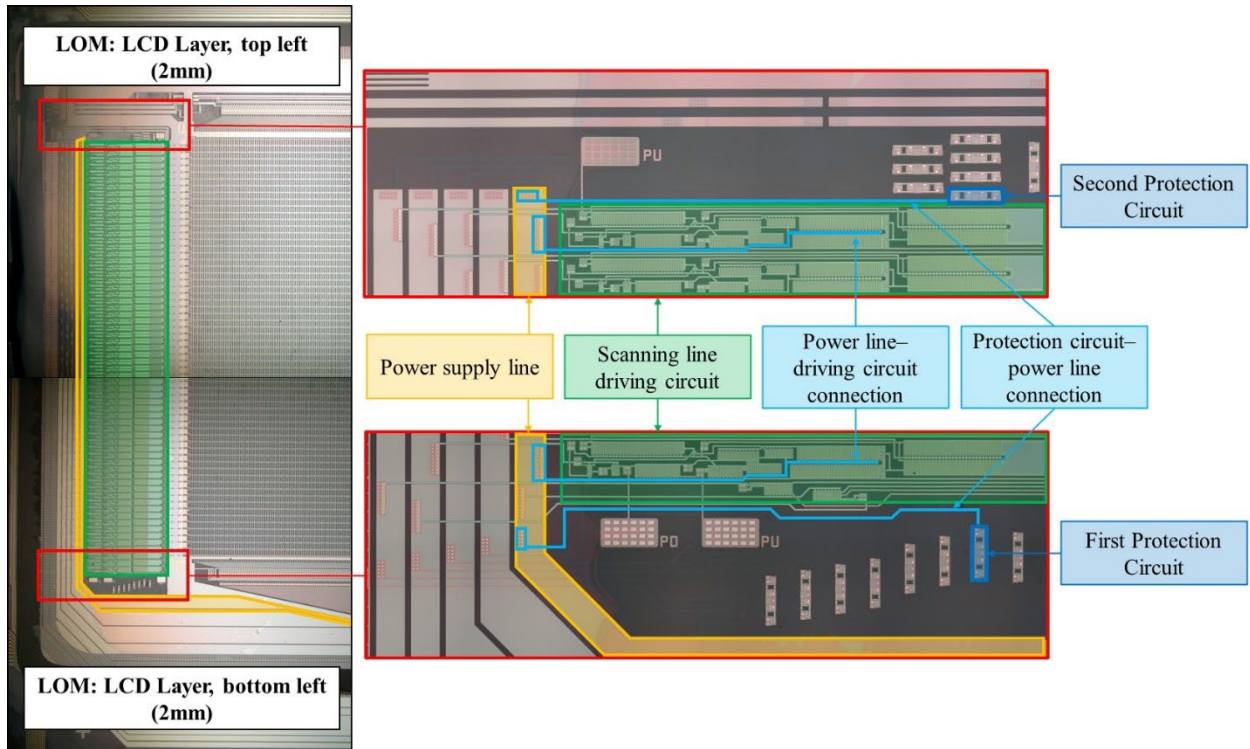

137. On information and belief, the first and second protective circuits in the BOE LCD panel used in the HP 21kd monitor are diode ring protection circuits:

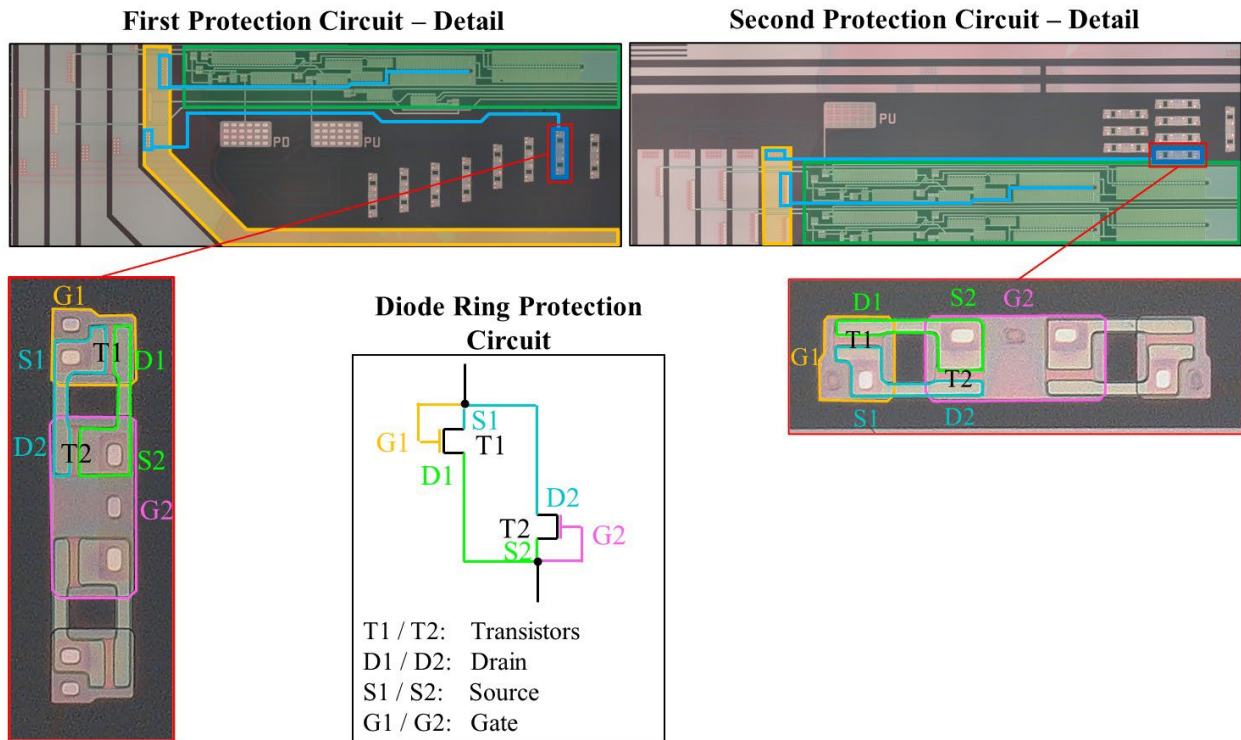

138. BOE display modules and panels, including, for example, the LCD panel used in the HP 21kd monitor, are display devices comprising the first protection circuit being connected to the power supply line between (i) a first connecting portion at which the scanning line driving circuit and the power supply line are connected and (ii) the input terminal. In the BOE LCD panel used in the HP 21kd monitor, the first protection circuit is connected to the power supply line between (i) a first connecting portion at which the scanning line driving circuit and the power supply line are connected and (ii) the input terminal:

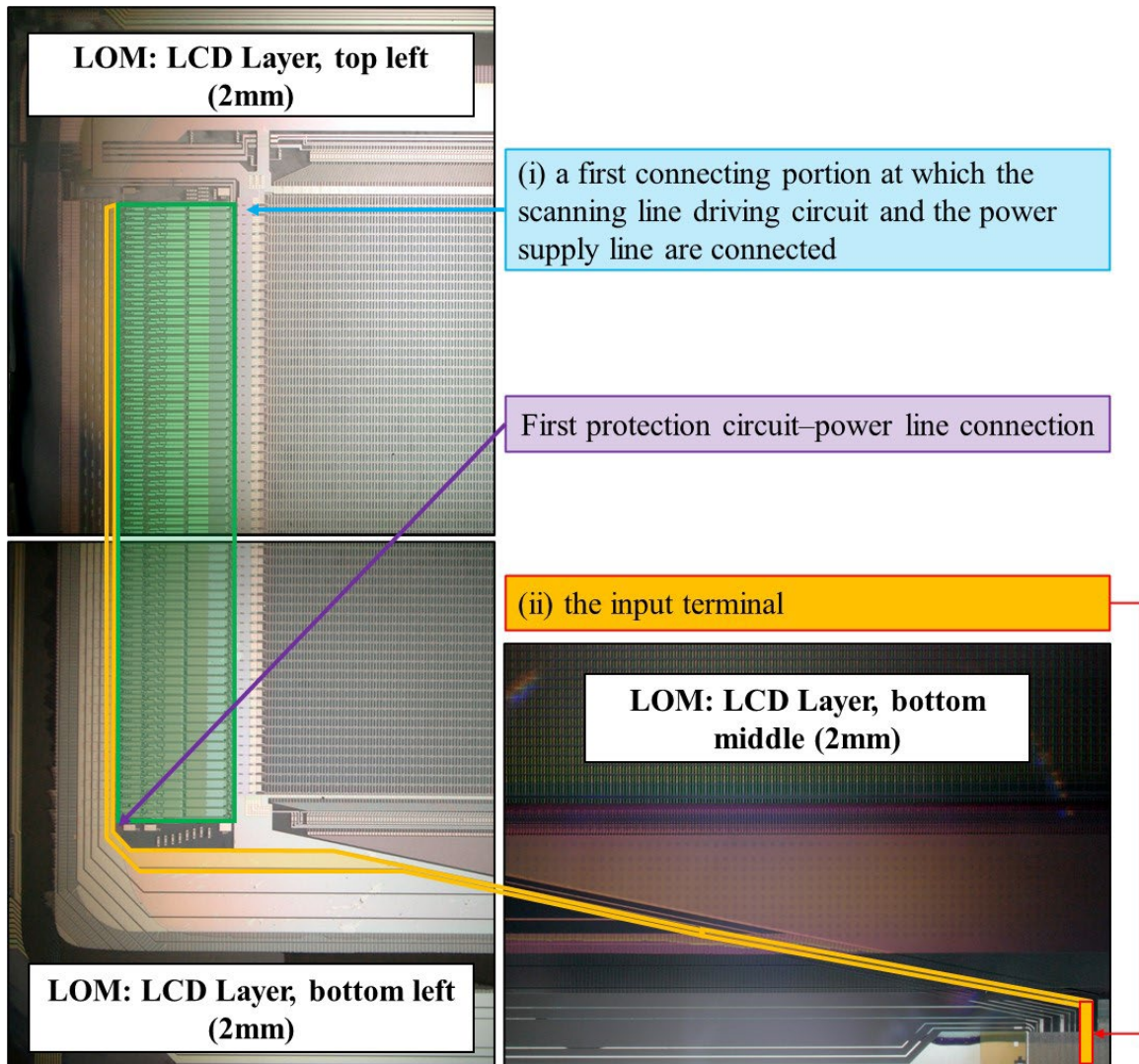

139. The first connecting portion is where the scanning line driving circuit and the power supply line are connected:

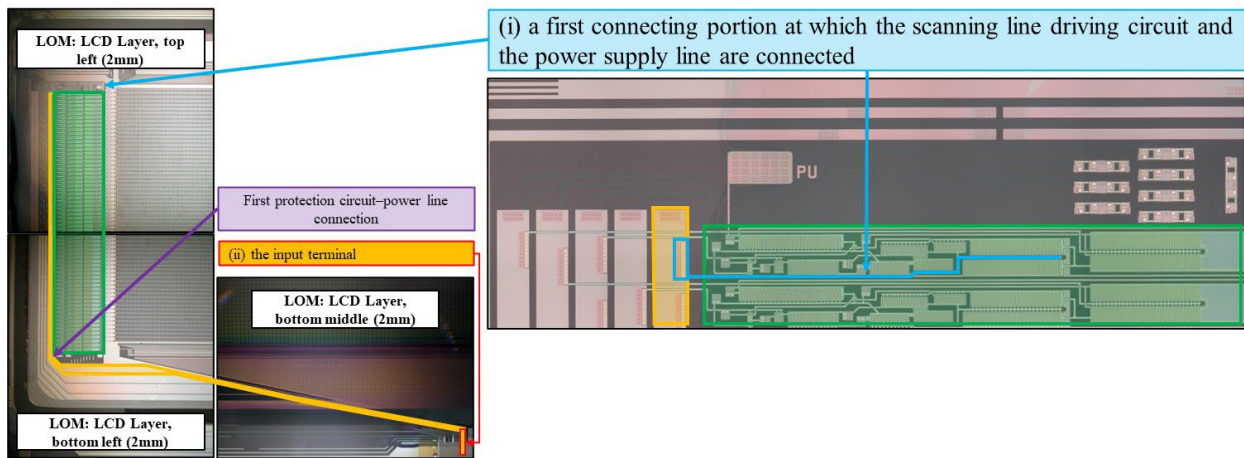

140. The connection between the first protection circuit and the power line, as shown below, is between the first connecting portion and the input terminal:

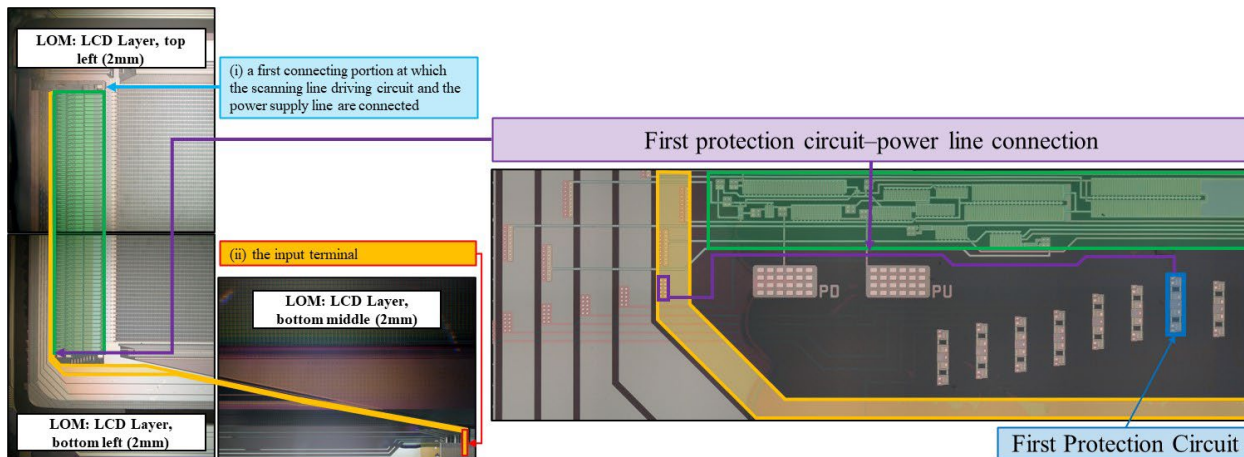

141. BOE display modules and panels, including, for example, the LCD panel used in the HP 21kd monitor, are display devices comprising the scanning line driving circuit being connected to the power supply line between (iii) a second connecting portion at which the first protection circuit and the power supply line are connected and (iv) a third connecting portion at which the second protection circuit and the power

supply line are connected. In the BOE LCD panel used in the HP 21kd monitor, the scanning line driving circuit is connected to the power supply line between (iii) a second connecting portion at which the first protection circuit and the power supply line are connected and (iv) a third connecting portion at which the second protection circuit and the power supply line are connected:

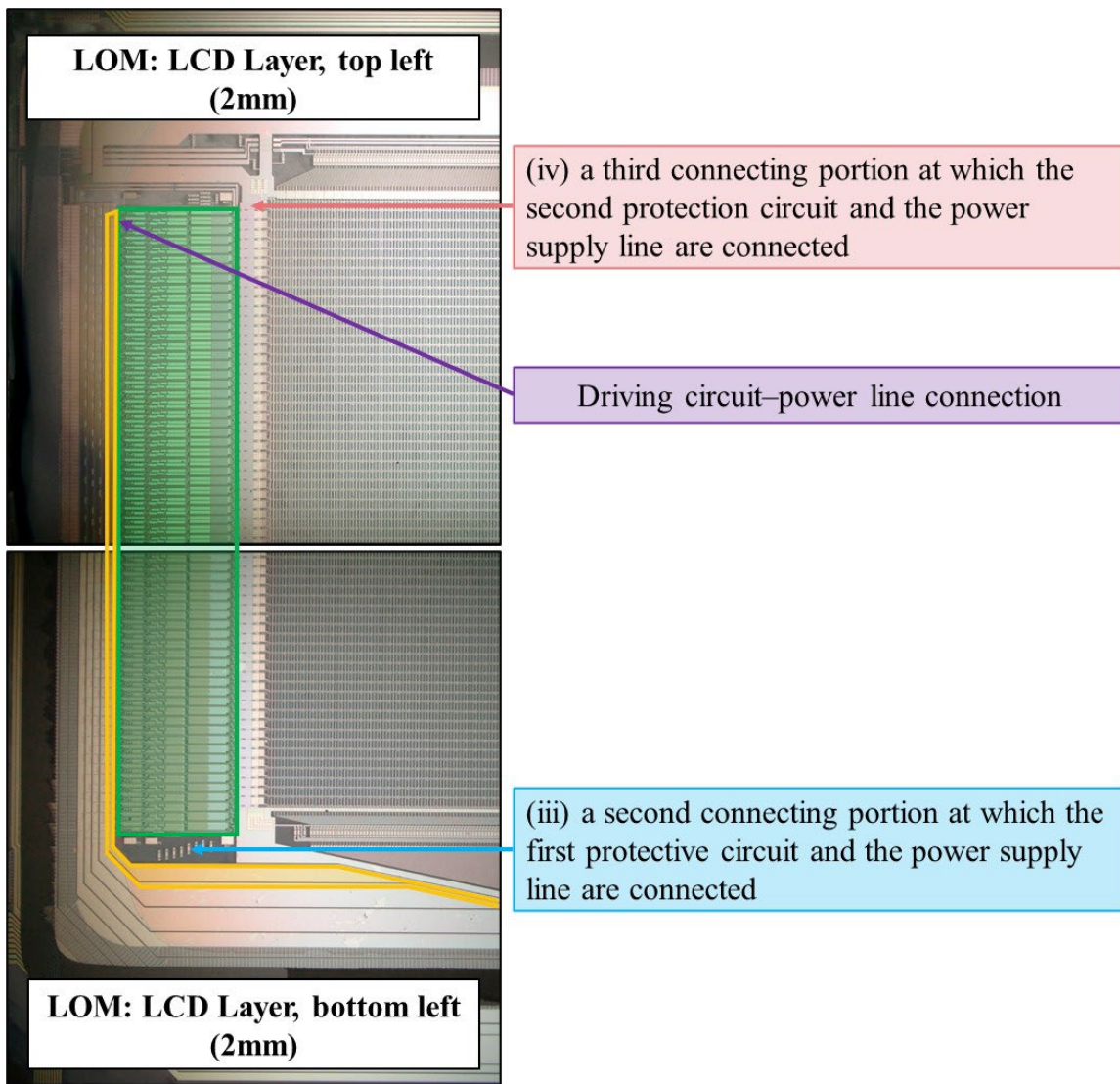

142. The third connecting portion is a portion at which the second protection circuit and the power supply line are connected:

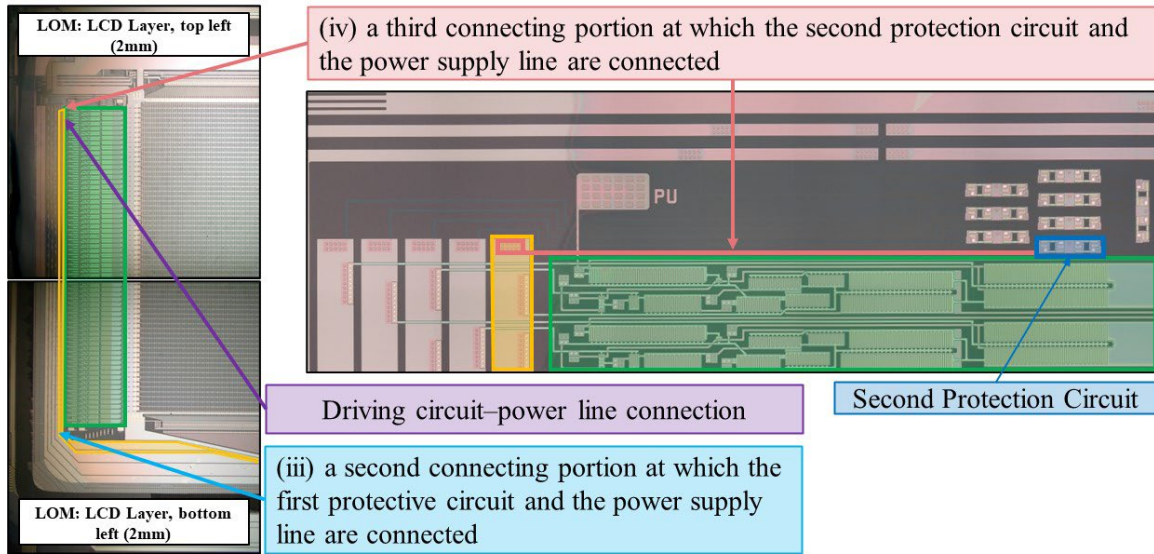

143. The second connecting portion is a portion at which the first protection circuit and the power supply line are connected:

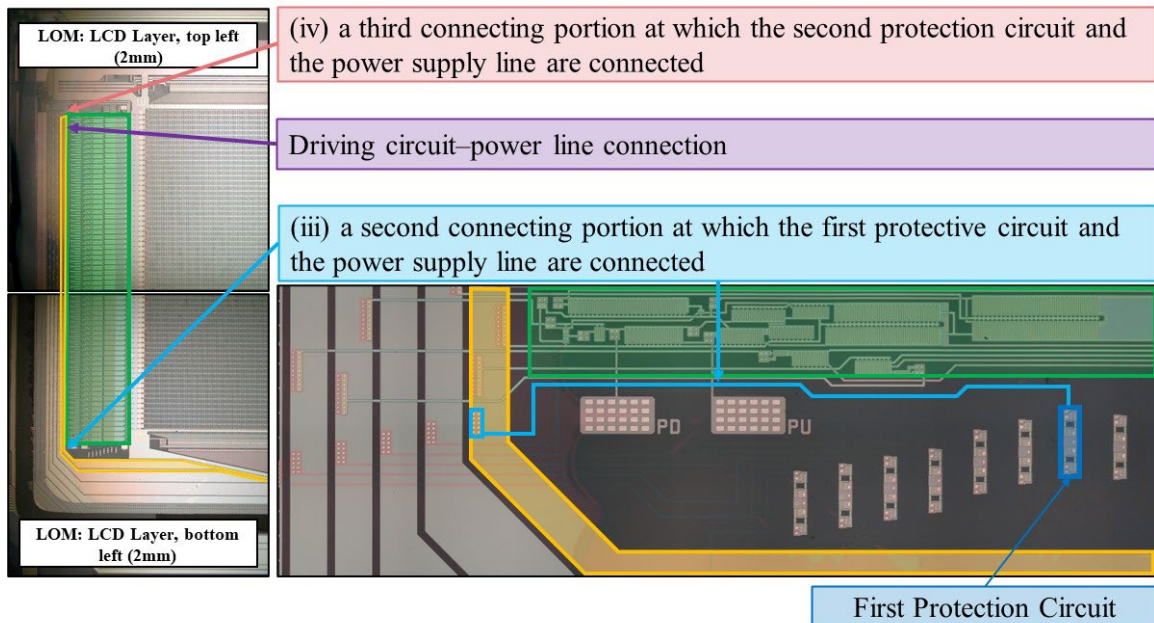

144. The scanning line driving circuit is connected to the power supply line between the second and third connecting portions:

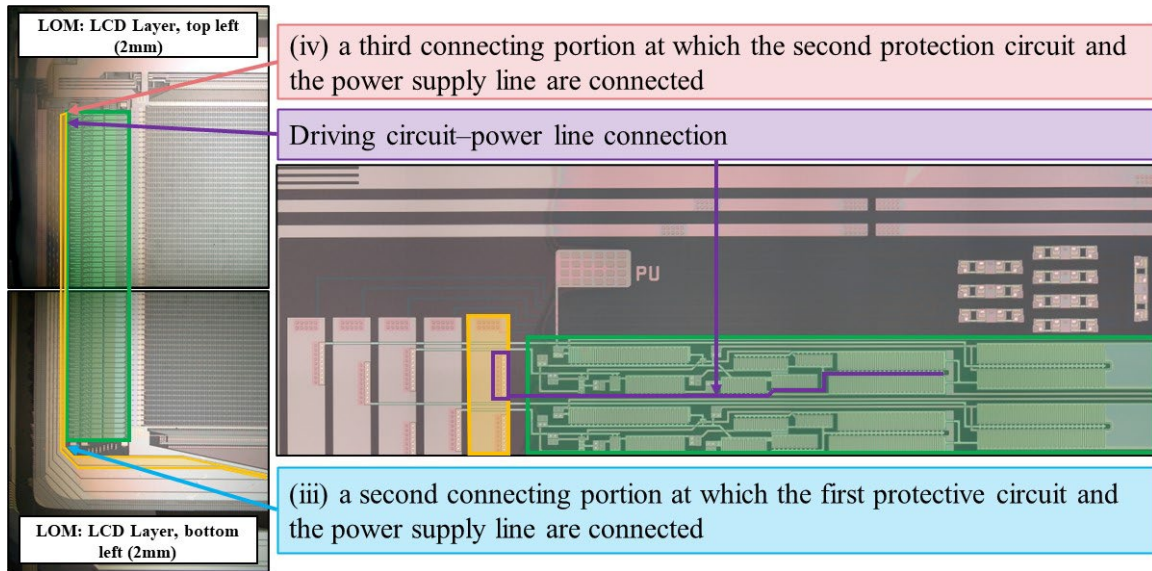

145. BOE has indirectly infringed and continues to indirectly infringe the '157 patent by actively inducing, in violation of 35 U.S.C. § 271(b), the direct infringement of the '157 patent by others in the United States, the State of Texas, and the Eastern District of Texas.

146. BOE has induced, and continues to induce, through affirmative acts, its customers and other third parties, including other importers, resellers, and end users in BOE's supply chain, to directly infringe the '157 patent by making, using, offering to sell, selling within the United States, and/or importing into the United States Accused Instrumentalities that infringe the '157 patent.

147. On information and belief, BOE actively promoted the Accused Instrumentalities for the U.S. market, as alleged here.

148. BOE knew that its customers would offer to sell and/or sell infringing Accused Instrumentalities in the United States or cause Accused Instrumentalities to be sold in the United States, and BOE specifically intended its customers to purchase

Accused Instrumentalities from BOE and offer to sell and/or sell the Accused Instrumentalities in the United States or cause Accused Instrumentalities to be sold in the United States. BOE's direct and indirect purchasers directly infringe the '157 patent by importing such Accused Instrumentalities into the United States, selling such Accused Instrumentalities in the United States, offering to sell such Accused Instrumentalities in the United States, and/or using such Accused Instrumentalities in the United States.

149. BOE has induced others' direct infringement despite actual notice that the Accused Instrumentalities infringe the '157 patent. As of the date BOE received Longitude's November 6, 2023 notice letter, or at least as of the date of this complaint, BOE knew that the induced conduct would constitute infringement—and intended that infringement at the time of committing the aforementioned affirmative acts, such that the acts and conduct have been and continue to be committed with the specific intent to induce infringement—or deliberately avoided learning of the infringing circumstances at the time of committing these acts so as to be willfully blind to the infringement that was induced.

150. BOE's direct and indirect infringement of the '157 patent is ongoing.

151. The above-described acts of infringement have caused and continue to cause injury and damage to Longitude.

152. BOE's infringement has been and continues to be willful.

153. Longitude is entitled to recover damages sustained as a result of BOE's willful infringement in an amount subject to proof at trial, but in no event less than a reasonable royalty.

COUNT V: INFRINGEMENT OF U.S. PATENT NO. 9,557,606

154. Pursuant to 35 U.S.C. § 282, the '606 patent is presumed valid.

155. BOE has directly infringed and continues to directly infringe one or more claims of the '606 patent, in violation of 35 U.S.C. § 271(a).

156. The Accused Instrumentalities directly infringe at least claim 7 of the '606 patent.

157. Paragraphs 159-171 describe how the Accused Instrumentalities infringe claim 7 of the '606 patent, by way of the exemplary BOE LCD panel in the HP 21kd monitor. Longitude's allegations of infringement are not limited to claim 7 or the exemplary product, and additional infringement will be identified and disclosed through discovery and in infringement contentions.

158. BOE LCD panels and modules, including, for example, the BOE LCD panel in the HP 21kd monitor, comprise a display device. The HP 21kd monitor panel is a BOE panel, as indicated by the "BOE" logo on the panel and module.







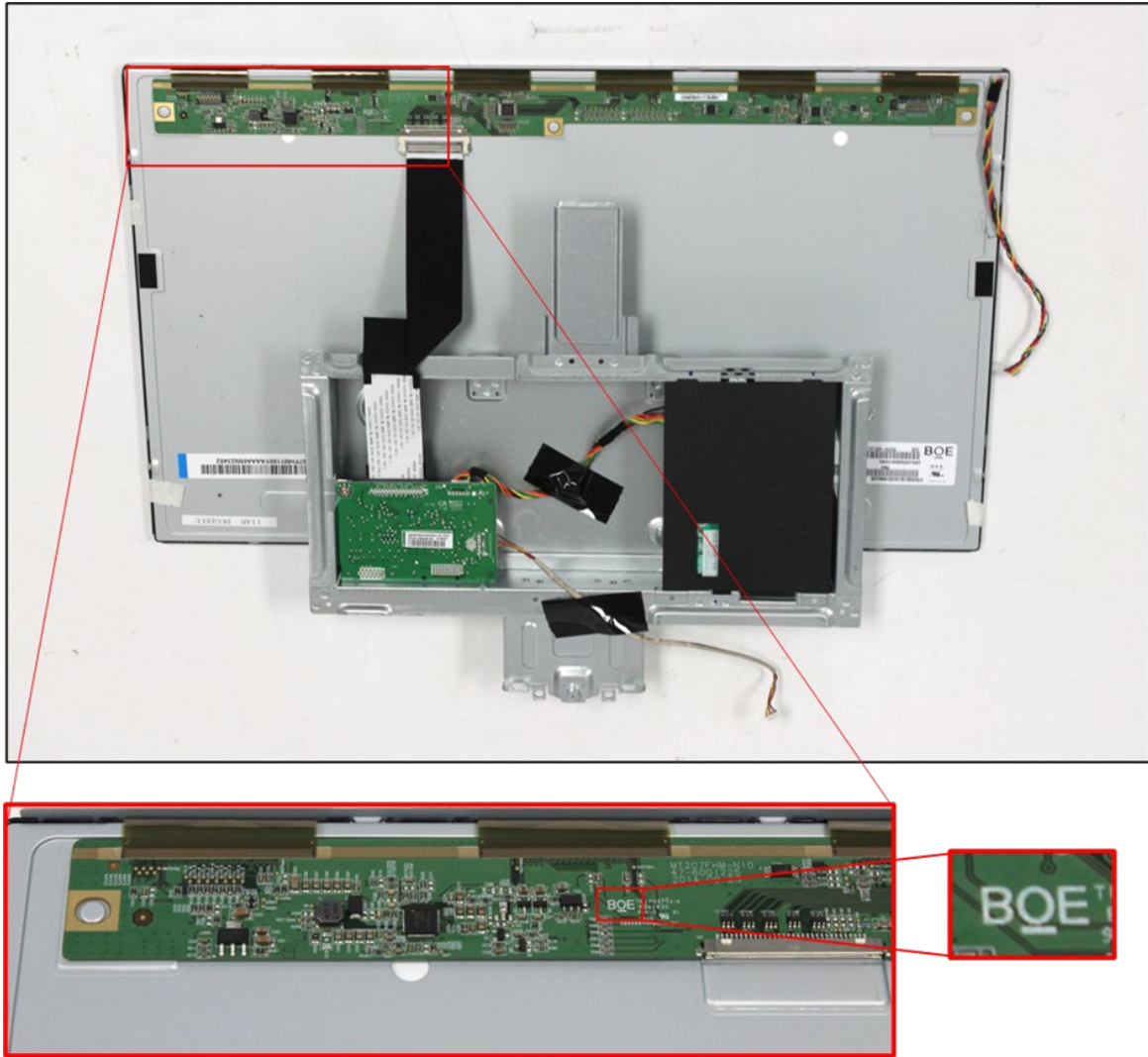

159. BOE LCD panels and modules, including, for example, the BOE LCD panel in the HP 21kd monitor, comprise a display device comprising a first substrate including a pixel region and a seal region which is defined around the pixel region on a first surface of the first substrate, the pixel region including a plurality of pixels and a plurality of active elements, and the seal region forming a rectangular ring shape, wherein the active elements are thin film transistors disposed on the first substrate:

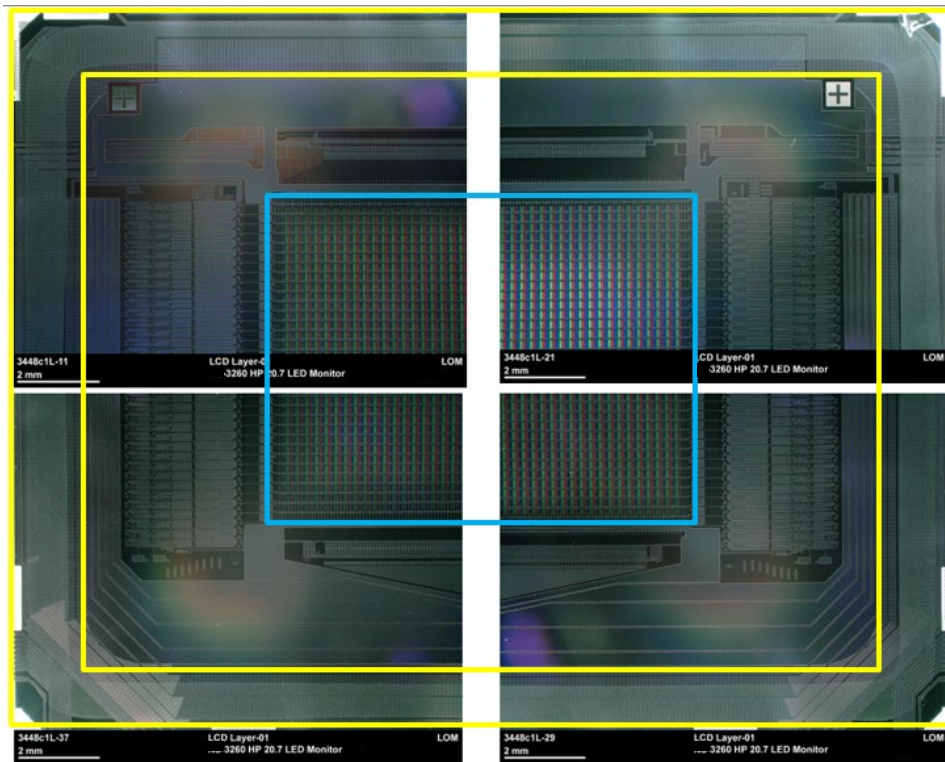
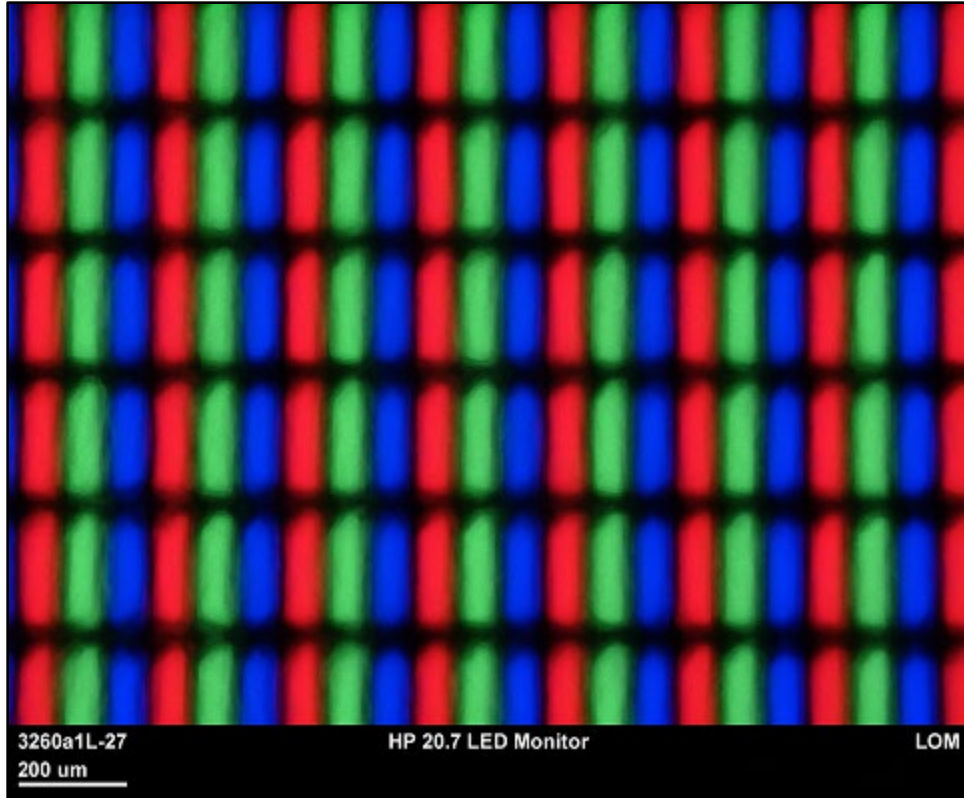

(blue identifying pixel region, yellow identifying seal region forming a rectangular ring)

shape around the pixel region, on the first substrate). The pixel region includes a plurality of pixels and a plurality of active elements, specifically, thin-film transistors (TFTs) disposed on the first substrate:

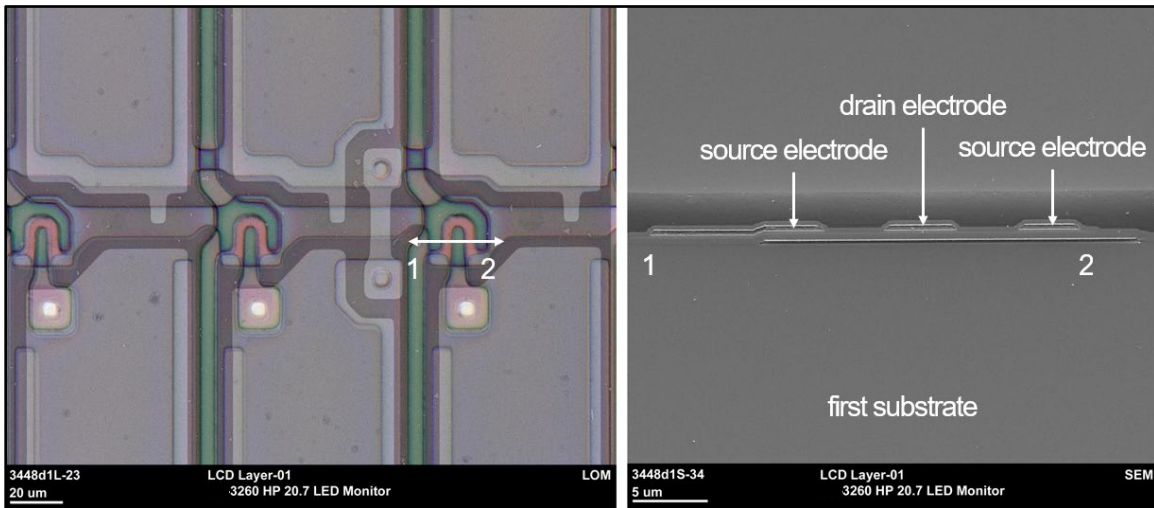
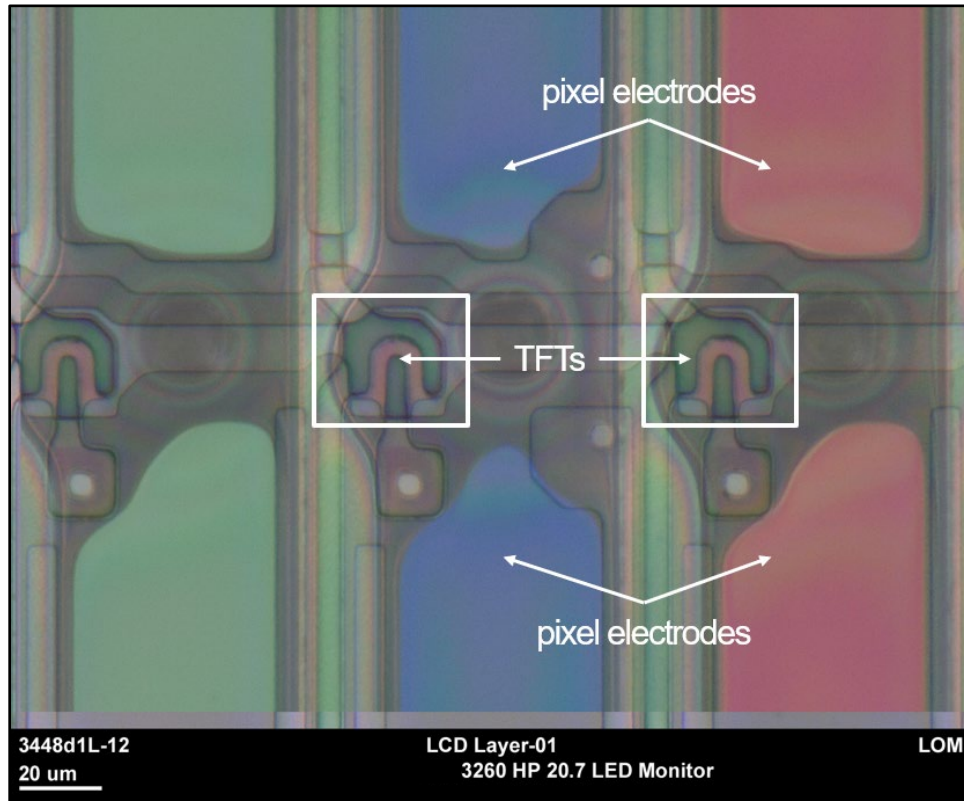

160. BOE LCD panels and modules, including, for example, the BOE LCD

panel in the HP 21kd monitor, comprise a display device comprising a second substrate including a common electrode on a second surface:

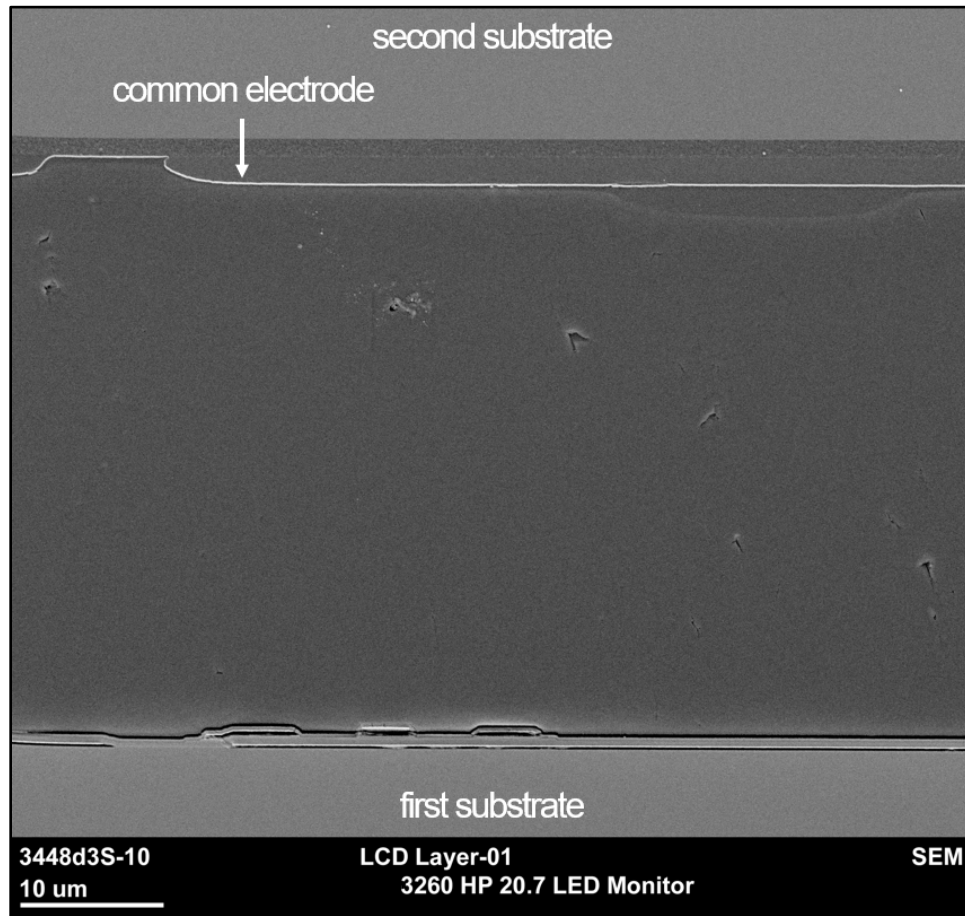

161. BOE LCD panels and modules, including, for example, the BOE LCD panel in the HP 21kd monitor, comprise a display device comprising a seal member bonding the first substrate and the second substrate so that the first surface faces the second surface and the common electrode is disposed opposite to the plurality of pixels:

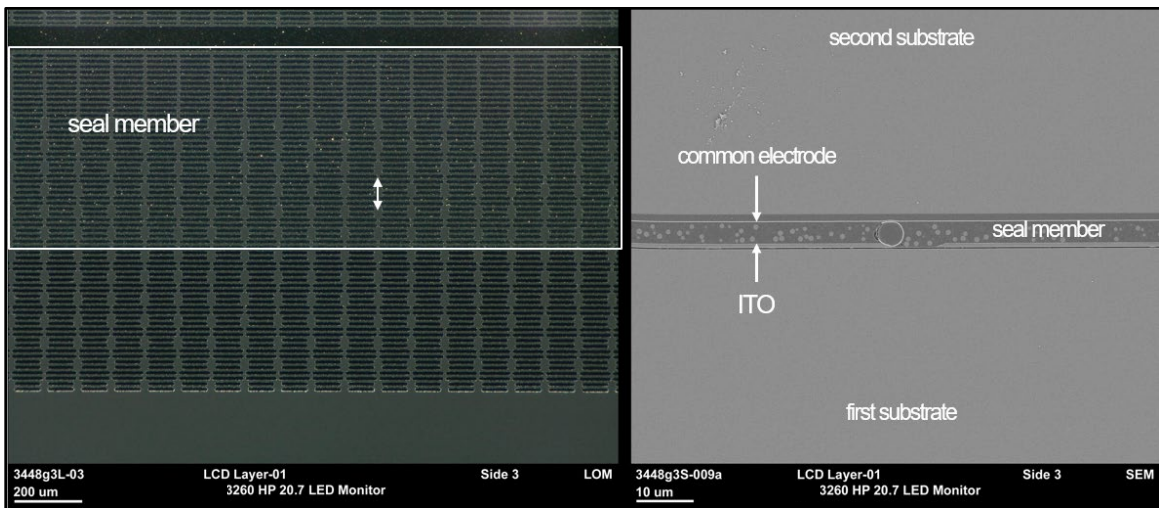
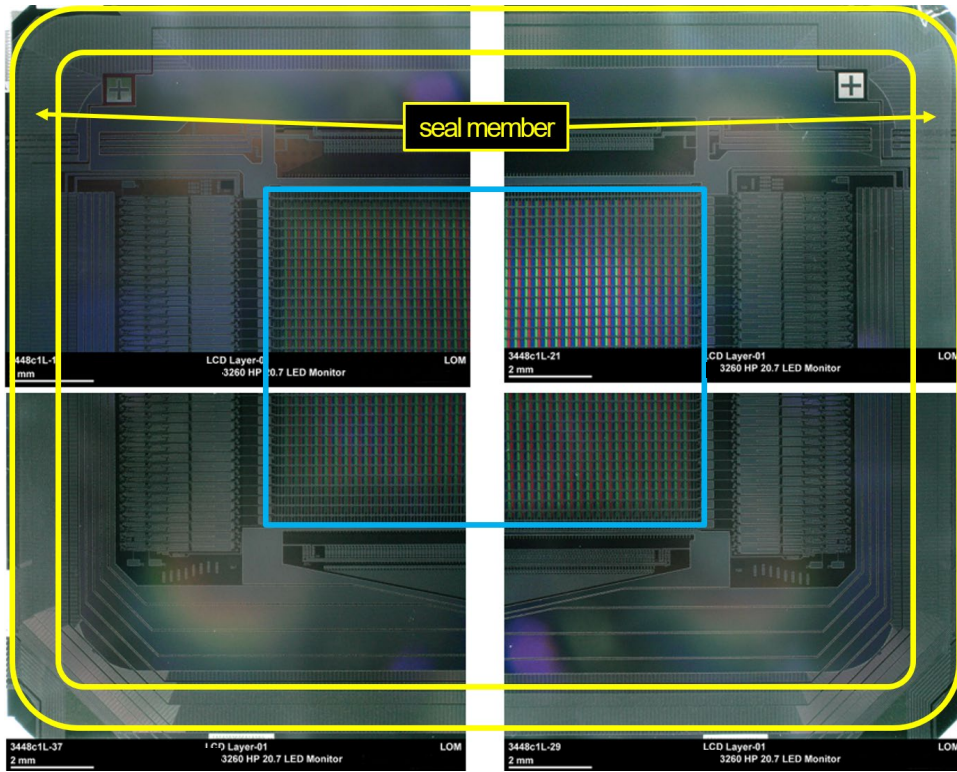

162. BOE LCD panels and modules, including, for example, the BOE LCD panel in the HP 21kd monitor, comprise a display device, wherein the first substrate includes a protruding region which protrudes over the second substrate in a plan view of the first substrate:

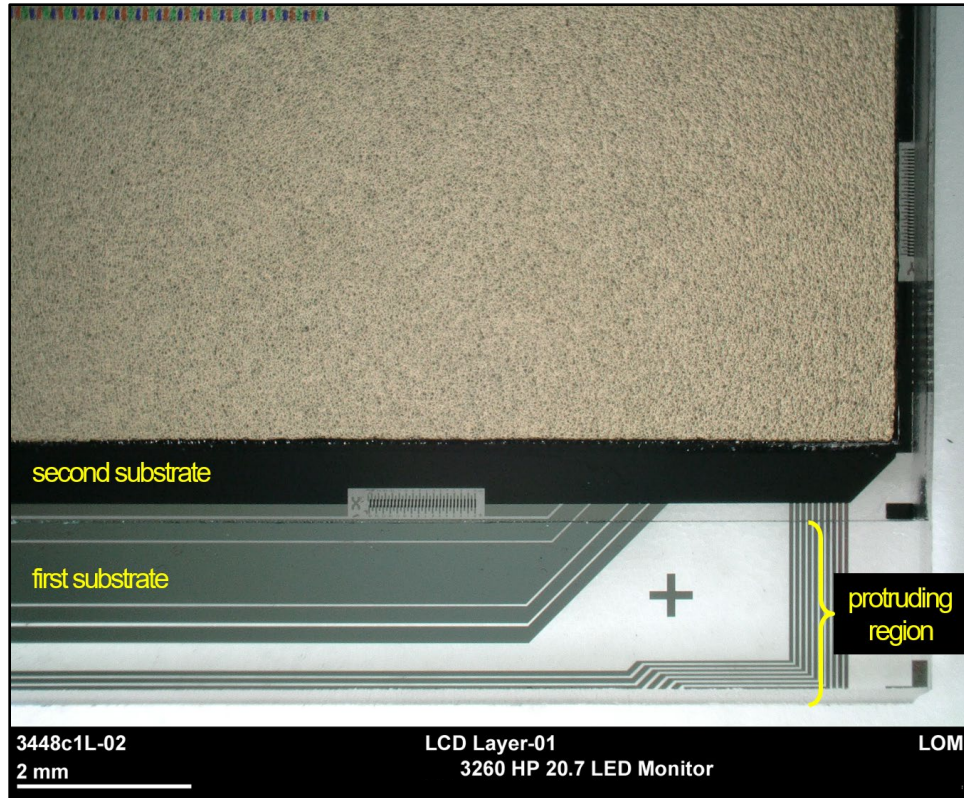

163. BOE LCD panels and modules, including, for example, the BOE LCD panel in the HP 21kd monitor, comprise a display device comprising a seal region, the seal region includes a first side, a second side, a third side and a fourth side, the first side is positioned between the pixel region and the protruding region, and opposed to the third side, and the second side is opposed to the fourth side:

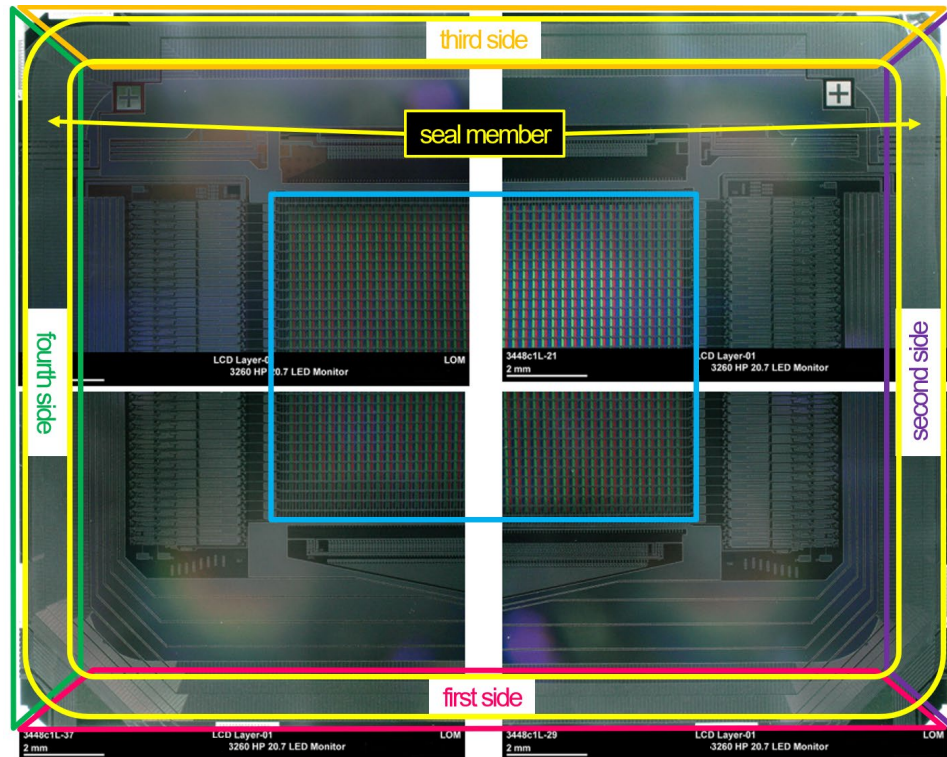

(protruding region on lower “south” side of panel).

164. BOE LCD panels and modules, including, for example, the BOE LCD panel in the HP 21kd monitor, comprise a display device and a seal member, the seal member is disposed between the first substrate and the second substrate, and positioned on the first side, the second side, the third side and the fourth side continuously, forms a closed-ring shape in which the pixel region is positioned without protruding from the second substrate in the plan view of the first substrate, and is formed continuously around the entire pixel region without the use of a plug. The seal member is disposed between the first substrate and the second substrate:

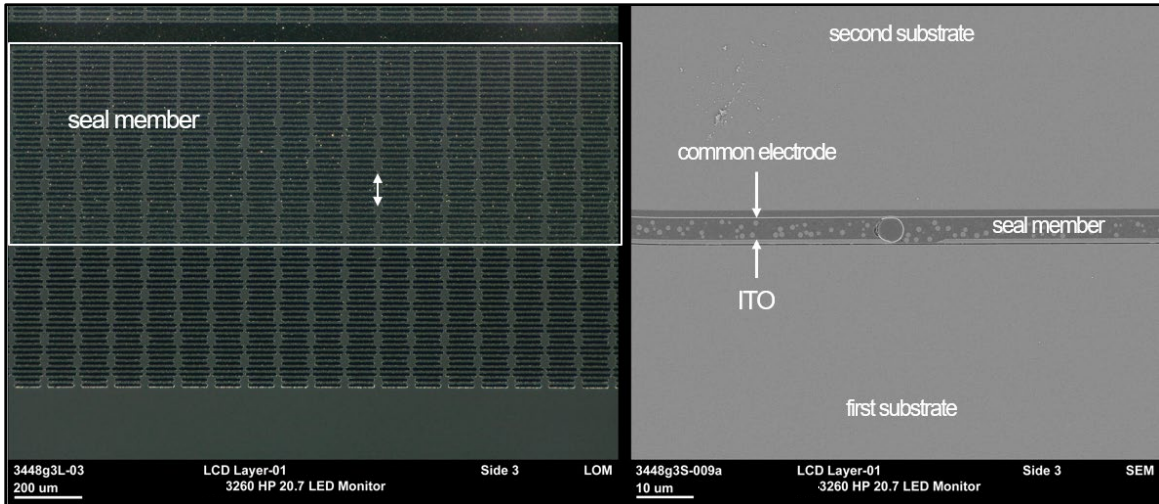

165. The seal member is positioned on the first side, the second side, the third side and the fourth side continuously, forming a closed-ring shape in which the pixel region is positioned without the use of a plug:

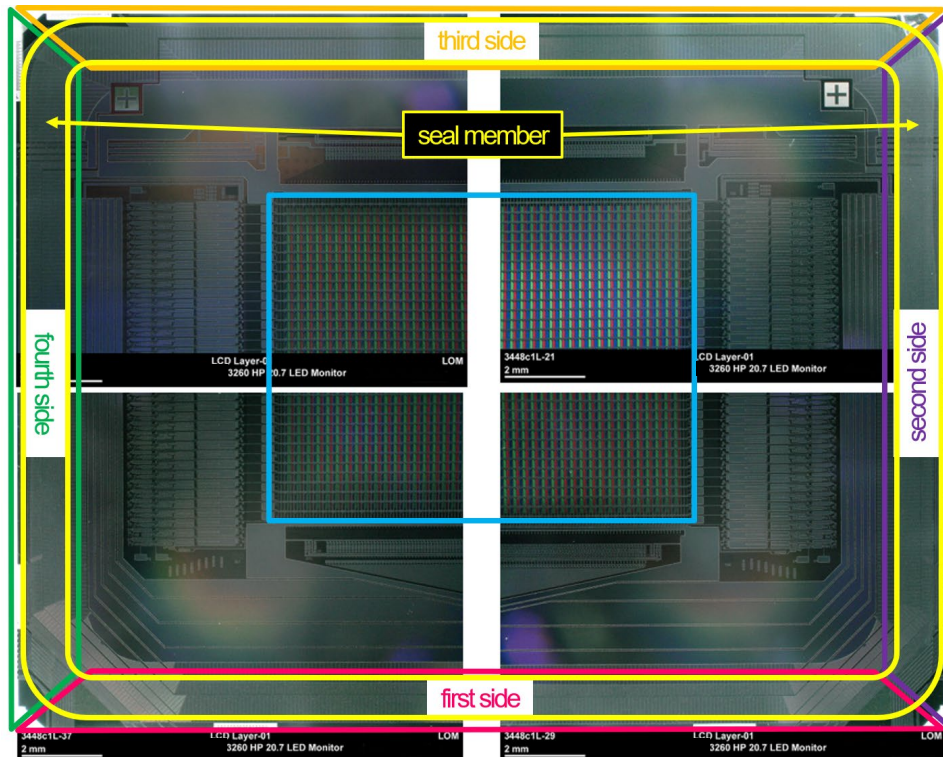

166. The seal member does not protrude from the second substrate in the plan view of the first substrate:

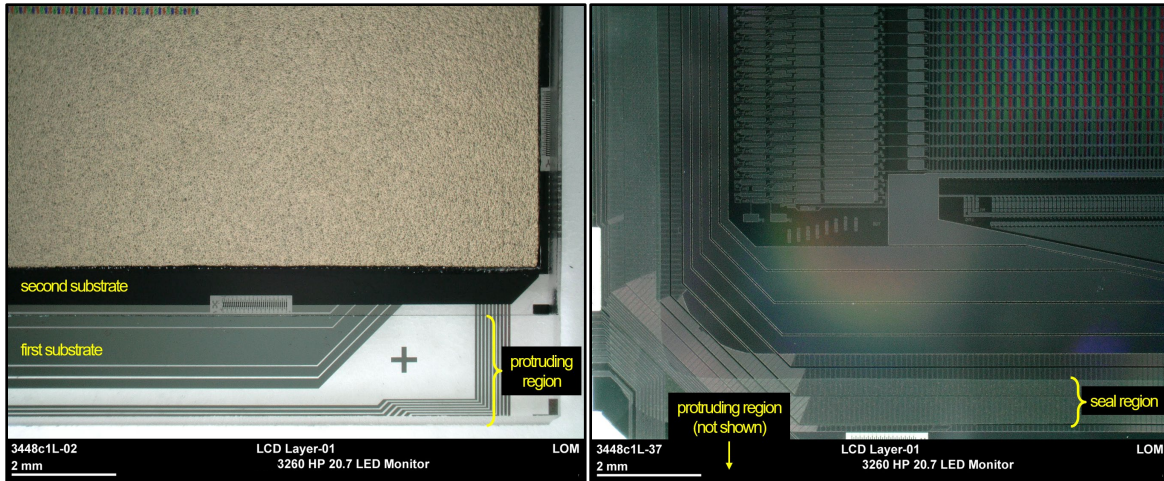

167. BOE LCD panels and modules, including, for example, the BOE LCD panel in the HP 21kd monitor, comprise a display device and a seal member, in which a first part of the seal member disposed on the third side which is opposed to the protruding region with respect to the pixel region includes a plurality of conductive particles:



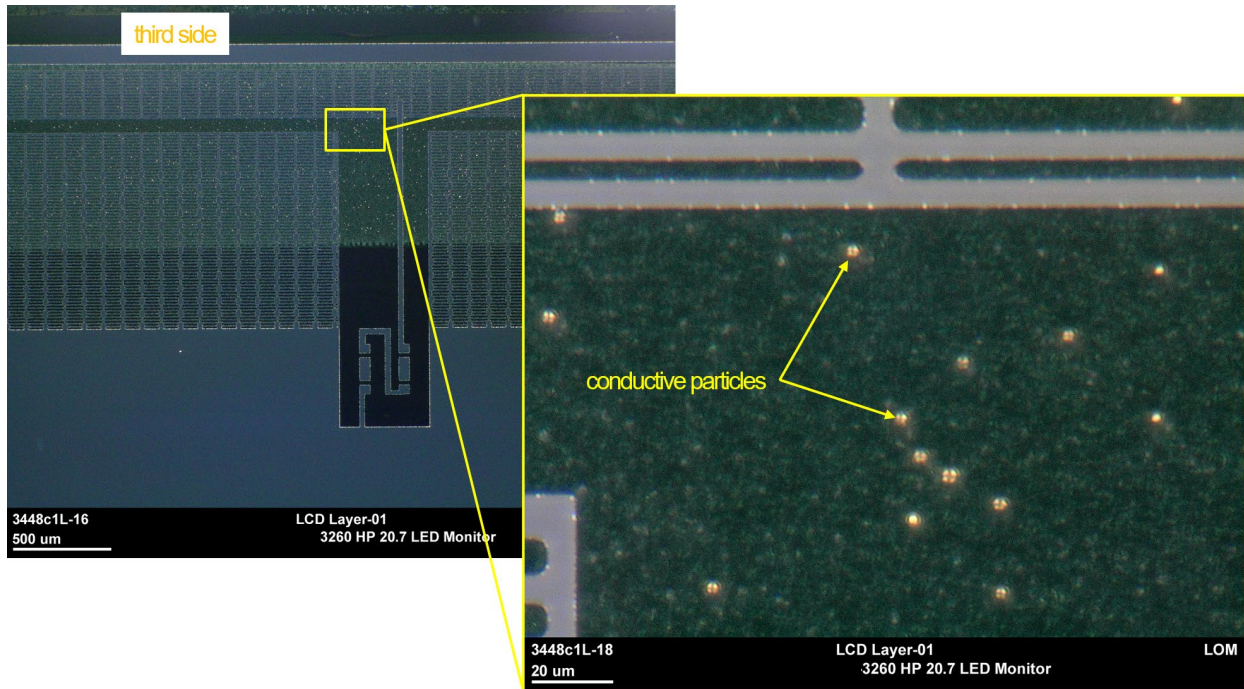

168. BOE LCD panels and modules, including, for example, the BOE LCD panel in the HP 21kd monitor, comprise a display device, wherein a plurality of dot conductive points are disposed on the third side of the first substrate, all of the plurality of the dot conductive points are electrically connected to the common electrode:

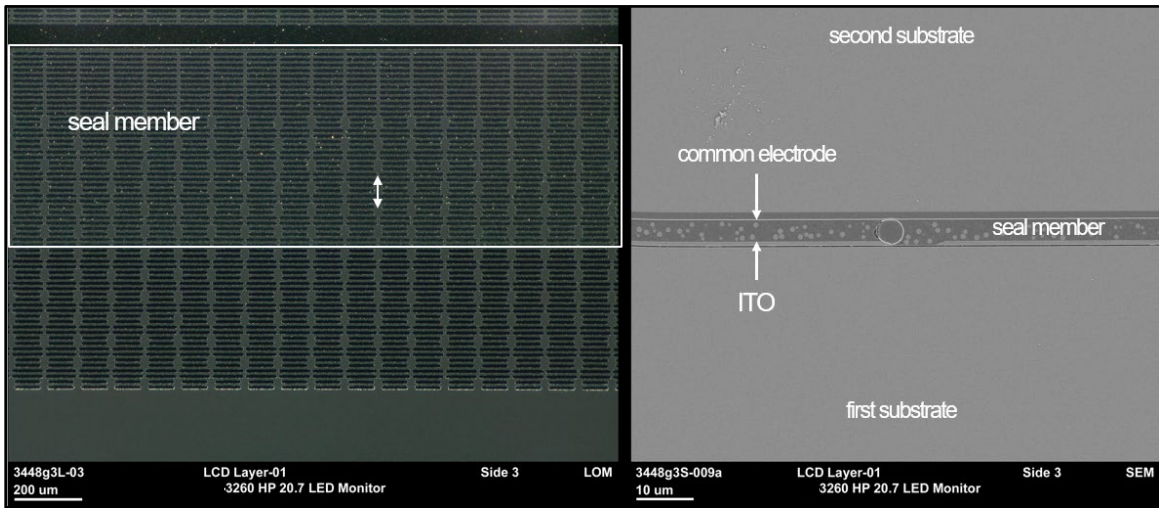
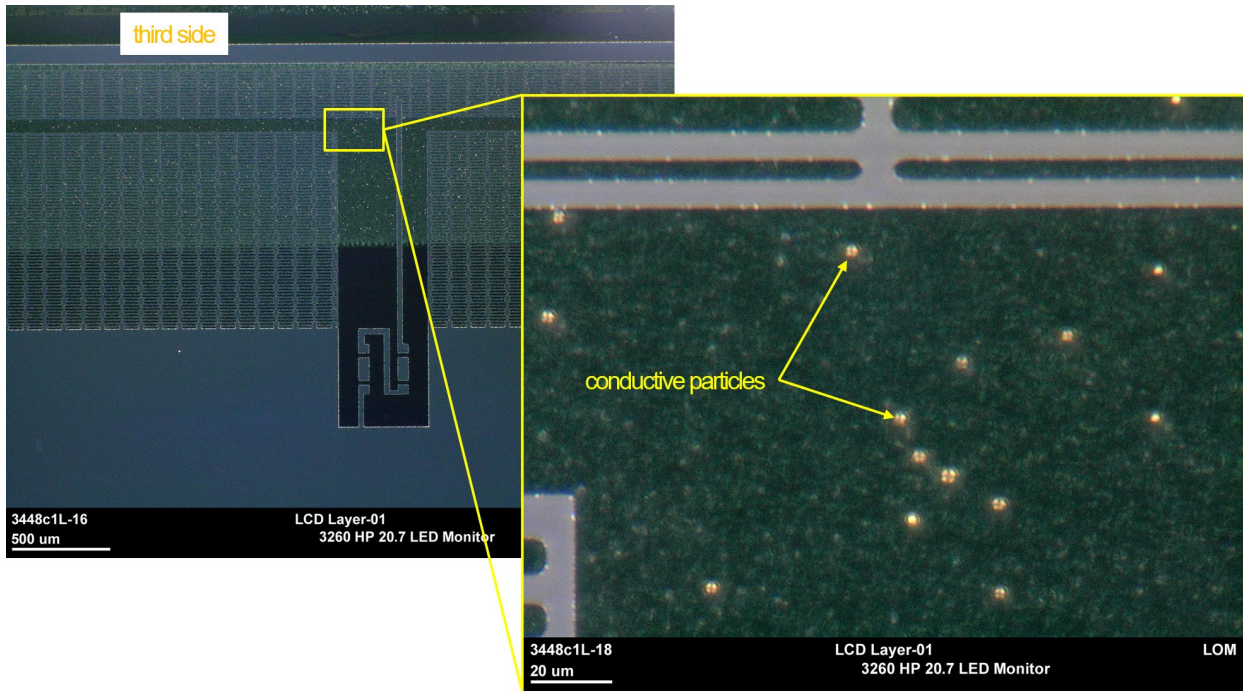

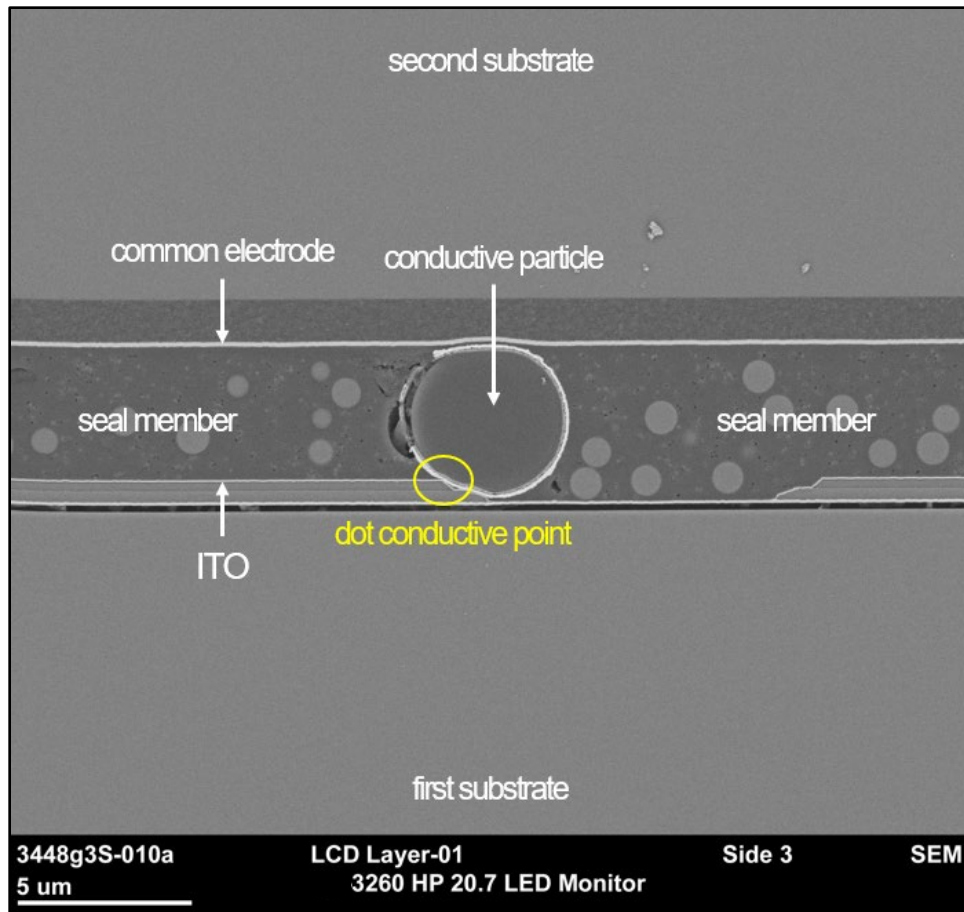

(dot conductive point where conductive particle contacts ITO).

169. BOE LCD panels and modules, including, for example, the BOE LCD panel in the HP 21kd monitor, comprise a display device, wherein each of the plurality of the dot conductive points are spaced apart from each other. Conductive particles—and, thus, dot conductive points—are spaced apart from each other as shown:

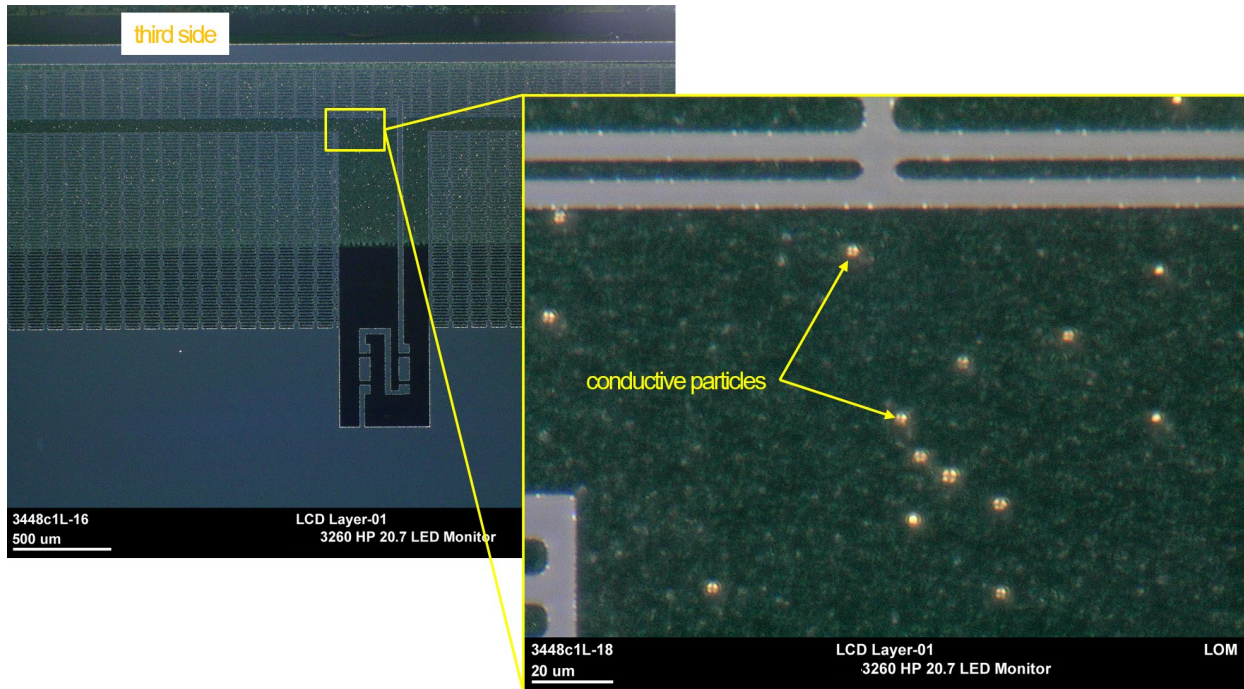

170. BOE LCD panels and modules, including, for example, the BOE LCD panel in the HP 21kd monitor, comprise a display device, wherein the first substrate includes a plurality of wiring lines (e.g., data lines) that connect to the plurality of active elements, and the plurality of wiring lines extend onto the protruding region across the seal member without connecting to the dot conductive points:

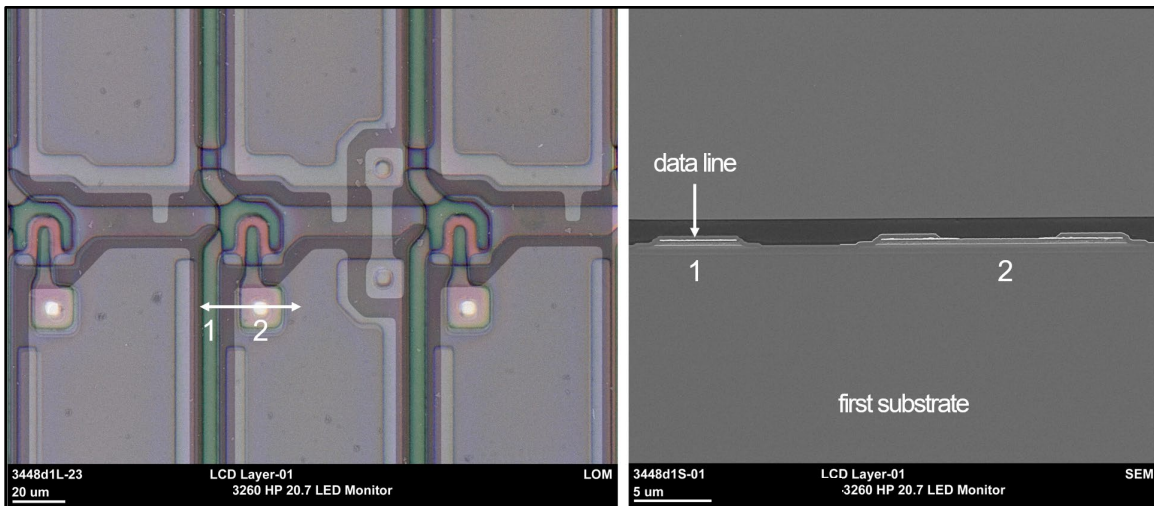
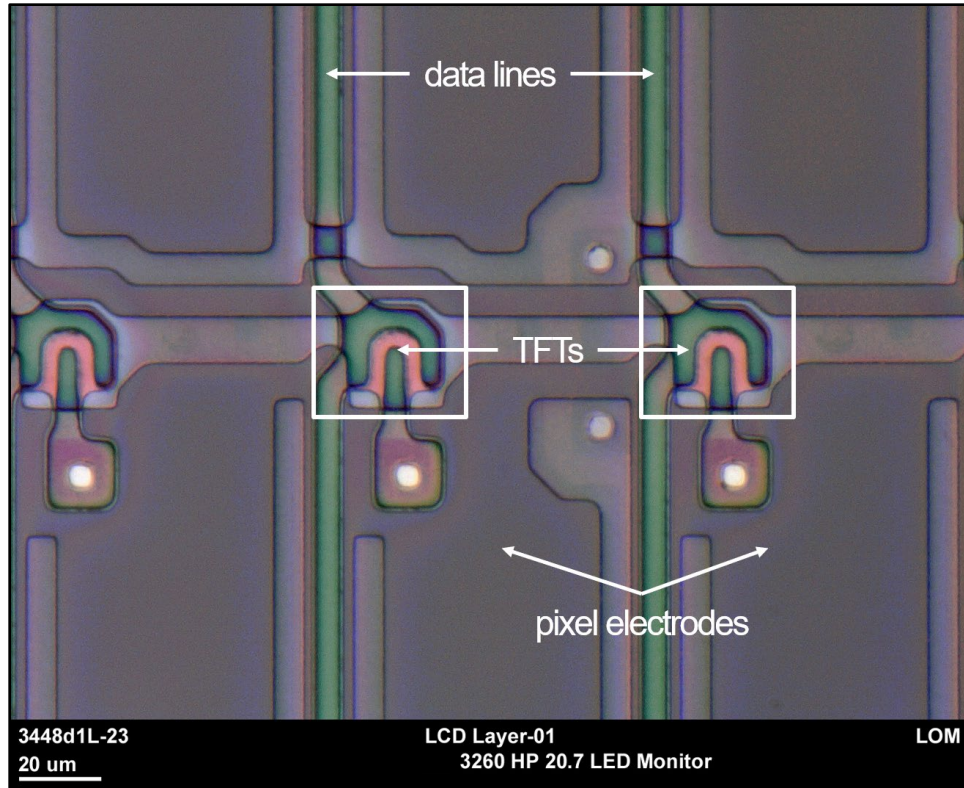

171. The data lines extend onto the protruding region across the seal member without connecting to the dot conductive points—if the data lines connected to the dot conductive points, they would short out:

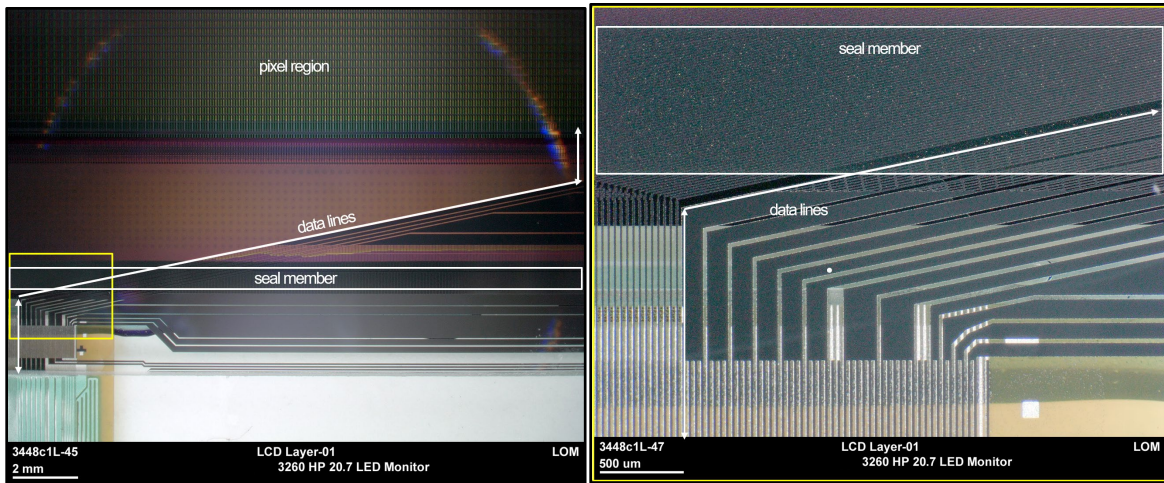
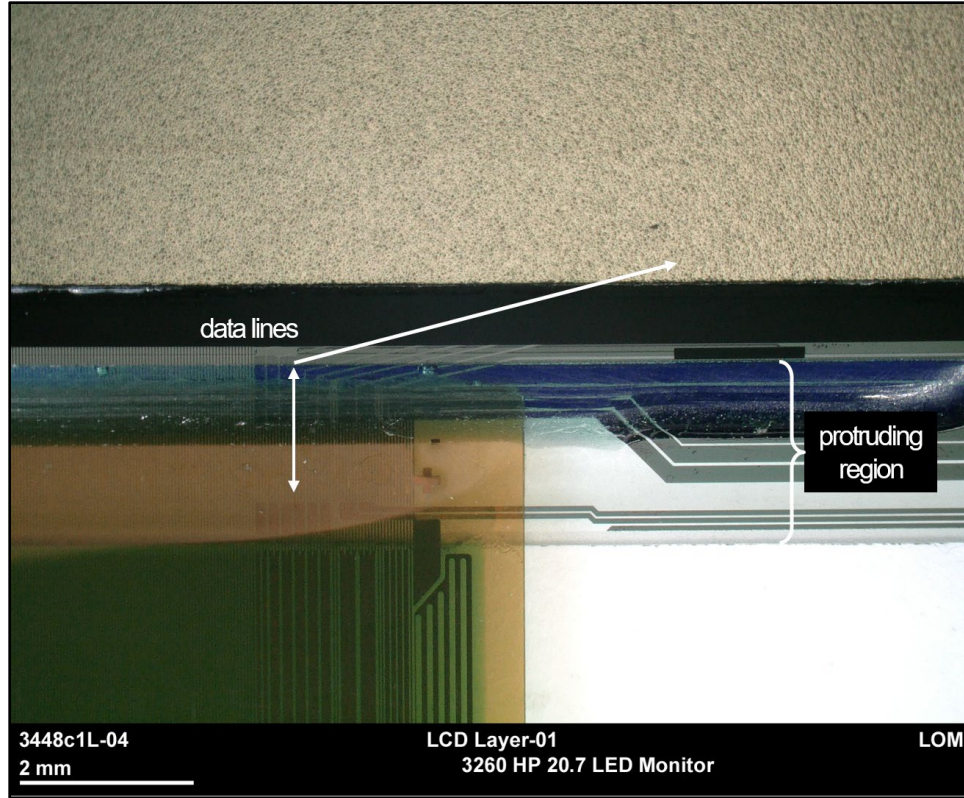

(showing flex connection to data lines, which extend across the protruding region and the seal member to connect to TFTs).

172. BOE has indirectly infringed and continues to indirectly infringe the '606 patent by actively inducing, in violation of 35 U.S.C. § 271(b), the direct infringement of the '606 patent by others in the United States, the State of Texas, and the Eastern District

of Texas.

173. BOE has induced, and continues to induce, through affirmative acts, its customers and other third parties, including other importers, resellers, and end users in BOE's supply chain, to directly infringe the '606 patent by making, using, offering to sell, selling within the United States, and/or importing into the United States Accused Instrumentalities that infringe the '606 patent.

174. On information and belief, BOE actively promoted the Accused Instrumentalities for the U.S. market, as alleged here.

175. BOE knew that its customers would offer to sell and/or sell infringing Accused Instrumentalities in the United States or cause Accused Instrumentalities to be sold in the United States, and BOE specifically intended its customers to purchase Accused Instrumentalities from BOE and offer to sell and/or sell the Accused Instrumentalities in the United States or cause Accused Instrumentalities to be sold in the United States. BOE's direct and indirect purchasers directly infringe the '606 patent by importing such Accused Instrumentalities into the United States, selling such Accused Instrumentalities in the United States, offering to sell such Accused Instrumentalities in the United States, and/or using such Accused Instrumentalities in the United States.

176. BOE has induced others' direct infringement despite actual notice that the Accused Instrumentalities infringe the '606 patent. As of at least April 8, 2021, BOE knew that the induced conduct would constitute infringement—and intended that infringement at the time of committing the aforementioned affirmative acts, such that the acts and conduct have been and continue to be committed with the specific intent to

induce infringement—or deliberately avoided learning of the infringing circumstances at the time of committing these acts so as to be willfully blind to the infringement that was induced.

177. BOE has indirectly infringed and continues to indirectly infringe the '606 patent by contributing, in violation of 35 U.S.C. § 271(c), to the direct infringement of the '606 patent by others in the United States, the State of Texas, and the Eastern District of Texas, specifically, by offering to sell, selling, and/or importing into the United States components (Accused Instrumentalities) of a claimed electronic device (*see, e.g.*, claim 12).

178. BOE's direct and indirect infringement of the '606 patent is ongoing.

179. The above-described acts of infringement have caused and continue to cause injury and damage to Longitude.

180. BOE's infringement has been and continues to be willful.

181. Longitude is entitled to recover damages sustained as a result of BOE's willful infringement in an amount subject to proof at trial, but in no event less than a reasonable royalty.

COUNT VI: INFRINGEMENT OF U.S. PATENT NO. 10,181,462

182. Pursuant to 35 U.S.C. § 282, the '462 patent is presumed valid.

183. BOE has directly infringed and continues to directly infringe one or more claims of the '462 patent, in violation of 35 U.S.C. § 271(a).

184. The Accused Instrumentalities directly infringe at least claim 1 of the '462 patent.

185. Paragraphs 187-198 describe the manner in which the Accused Instrumentalities infringe claim 1 of the '462 patent, by way of the exemplary BOE LCD panel in the HP 21kd monitor. Longitude's allegations of infringement are not limited to claim 1 or the exemplary product, and additional infringement will be identified and disclosed through discovery and in infringement contentions.

186. The LCD panel in the HP 21kd monitor is a BOE panel, as indicated by the "BOE" logo on the back of the LCD module and on the panel itself:

HP 21 kd Monitor



HP 21 kd Monitor, LCD Module (back view)

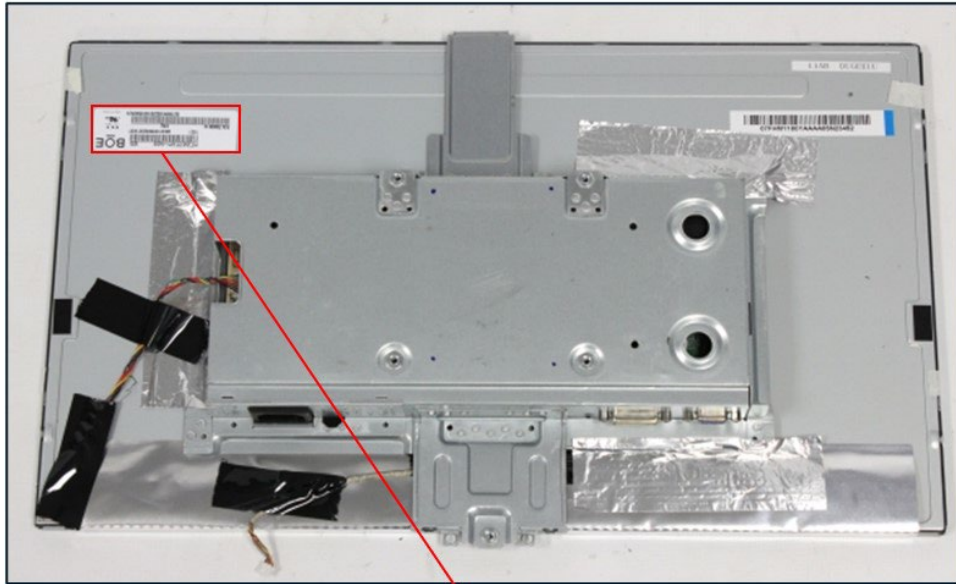

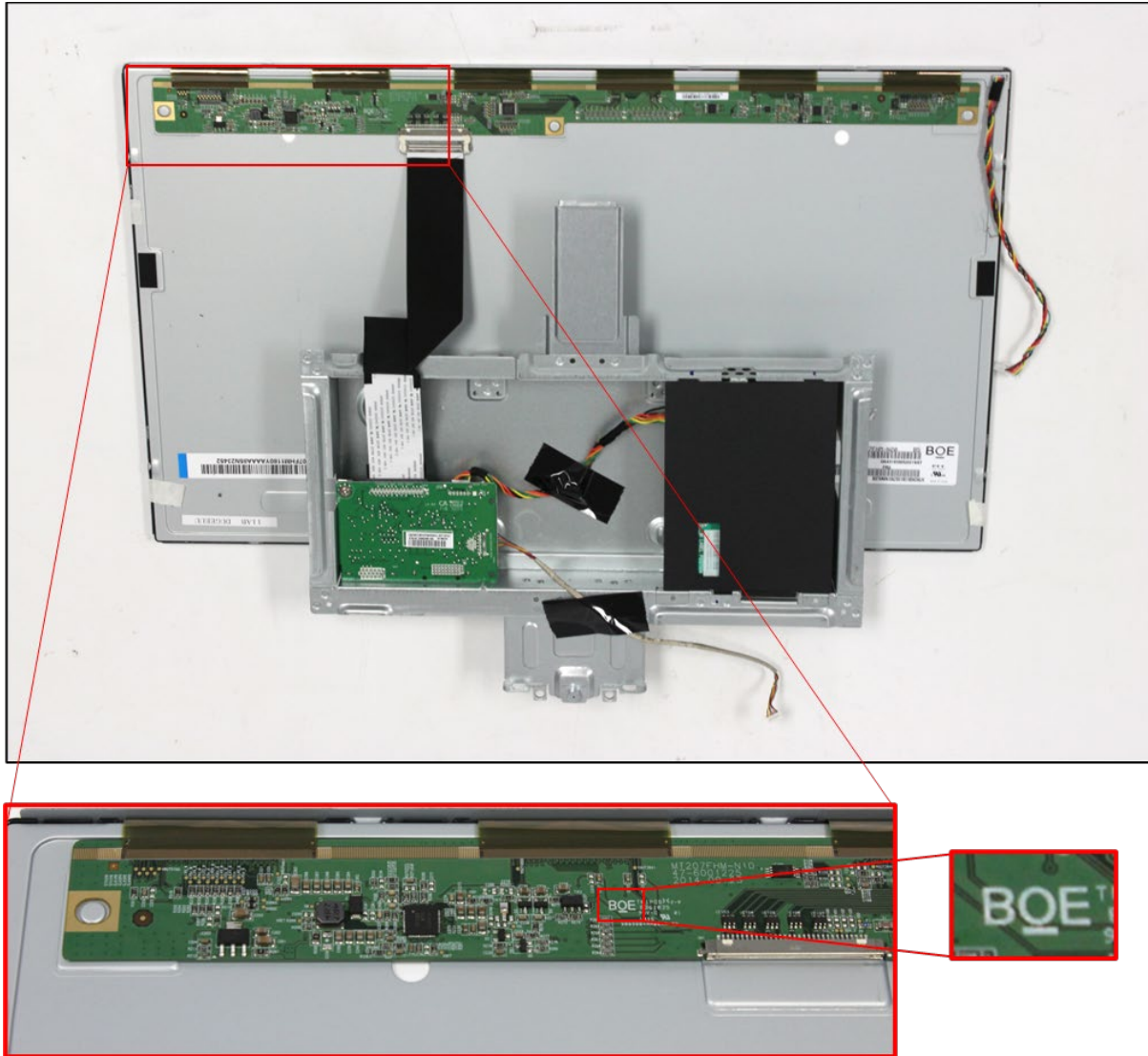

187. BOE display modules and panels, including, for example, the LCD panel used in the HP 21kd monitor, are display devices comprising a substrate:

LOM: Substrate, LCD layer (back), composite corners (1mm)

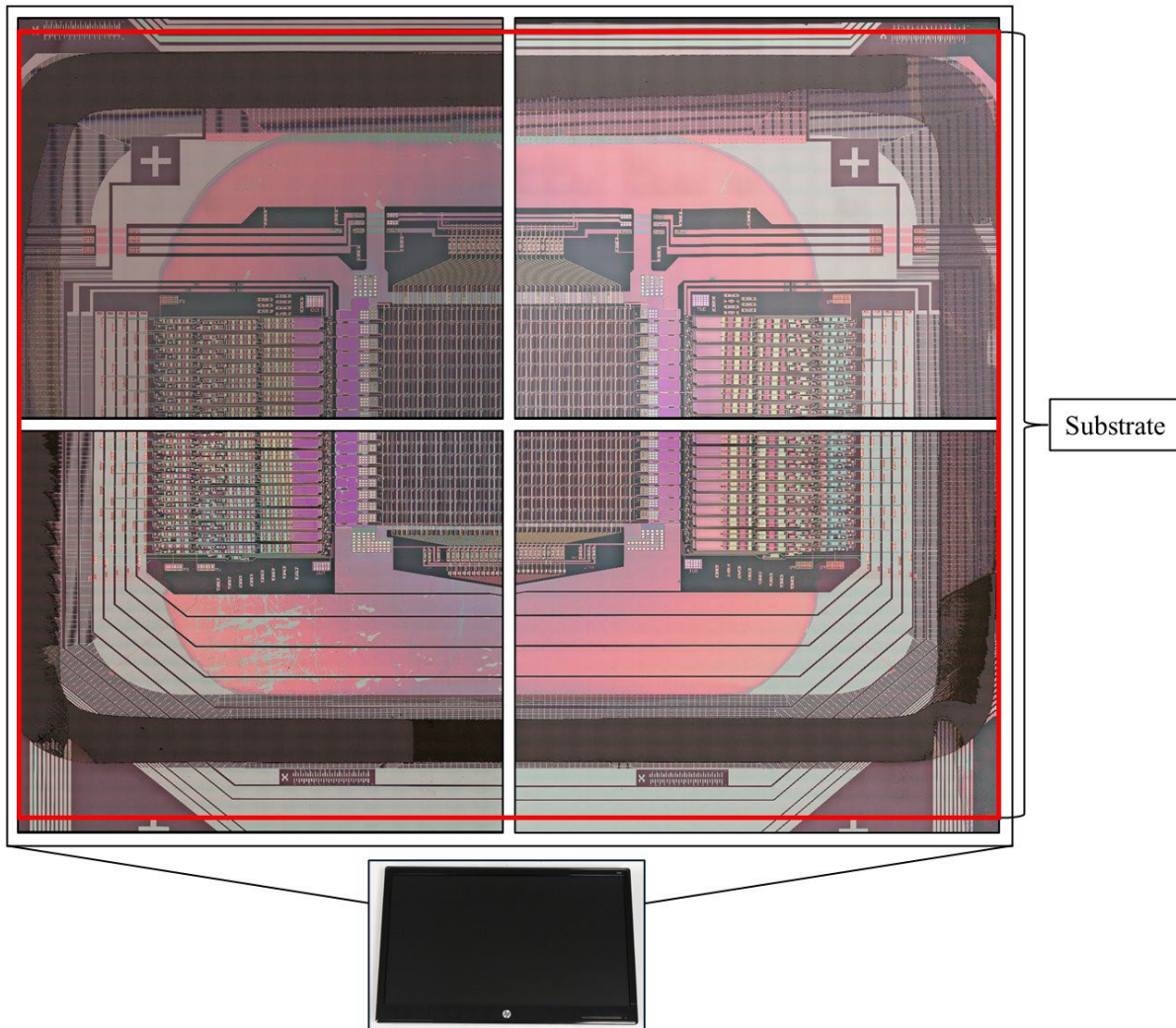

188. BOE display panels and modules, including, for example, the LCD panel used in the HP 21kd monitor, are display devices comprising an active matrix arranged

on the substrate:

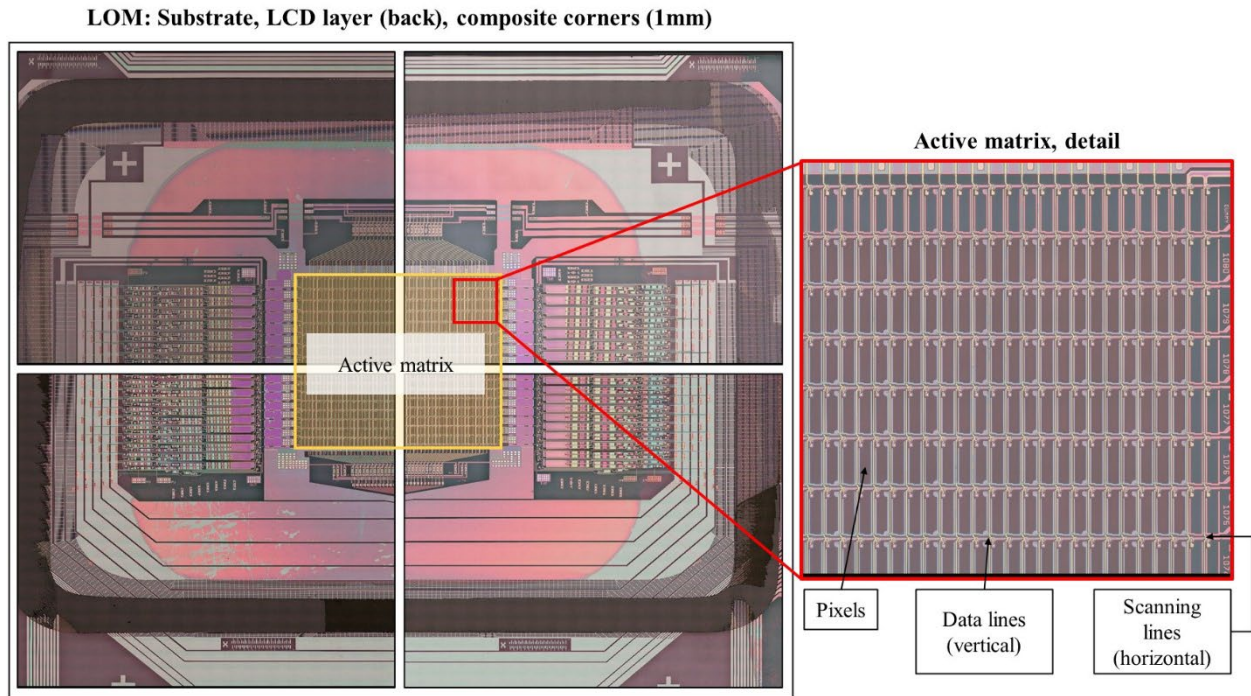

189. BOE display panels and modules, including, for example, the LCD panel used in the HP 21kd monitor, are display devices comprising a driving circuit arranged along one side interposed between a first corner of the substrate and a second corner of

the substrate at a peripheral area that surrounds the active matrix:

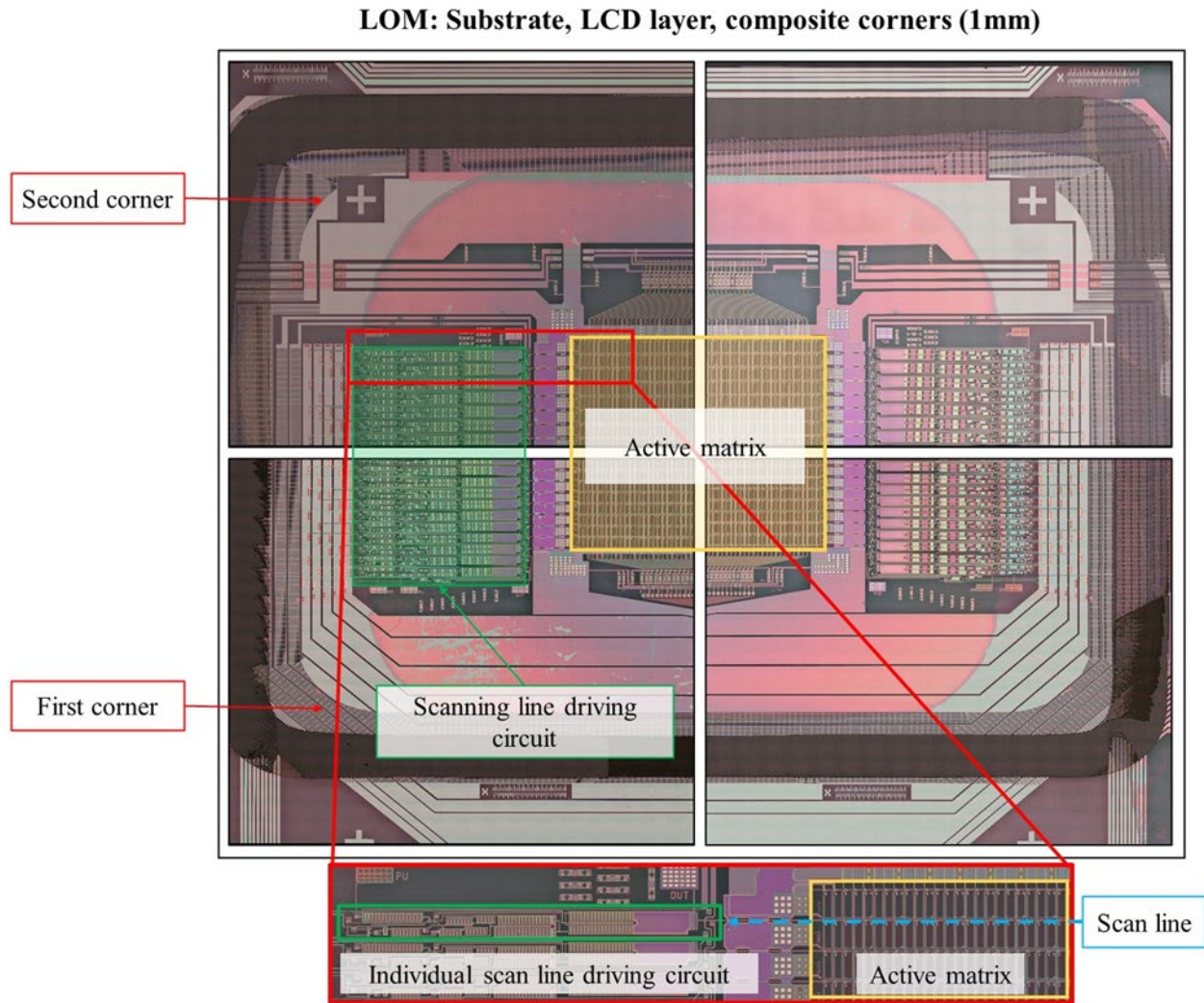

190. BOE display panels and modules, including, for example, the LCD panel used in the HP 21kd monitor, are display devices comprising a signal line connected to a first terminal and the driving circuit and supplying a driving signal to the driving circuit. The devices comprise a signal line connected to a first terminal, as shown below:

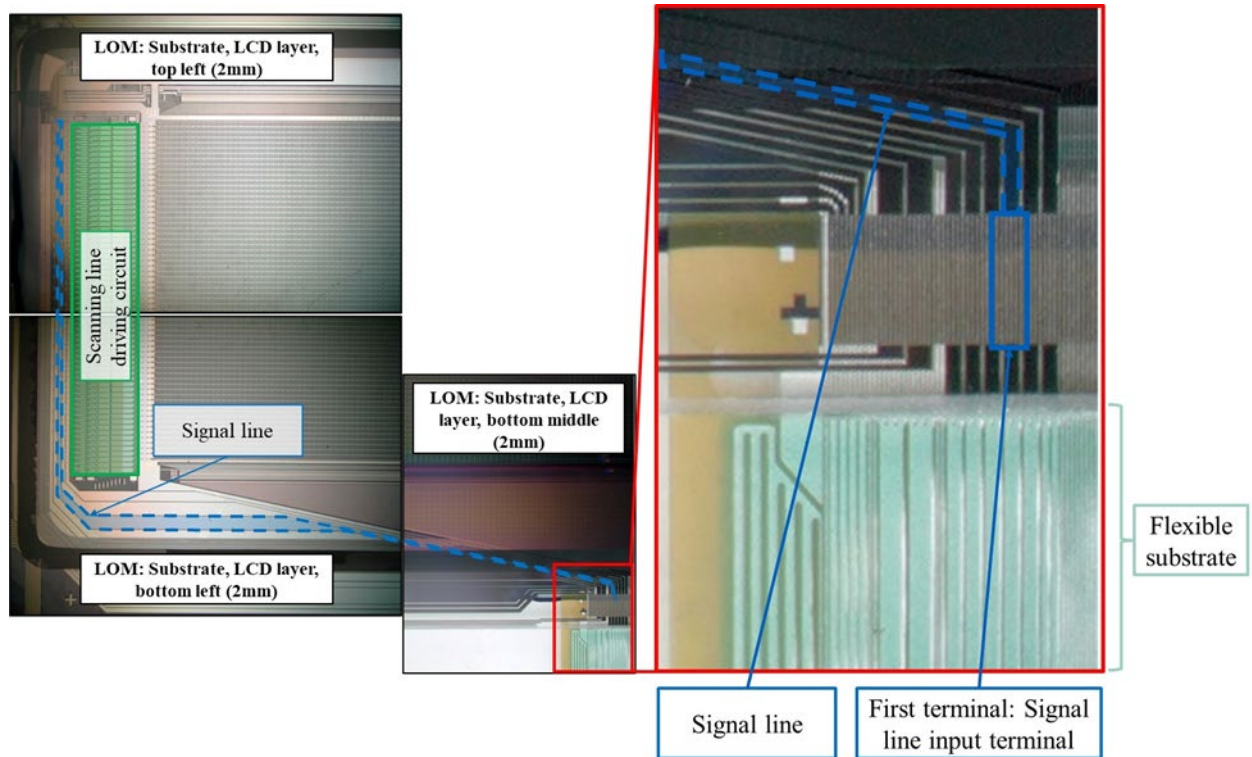

191. The devices further comprise the signal line connected to the driving circuit, and supplying a driving signal to the driving circuit:

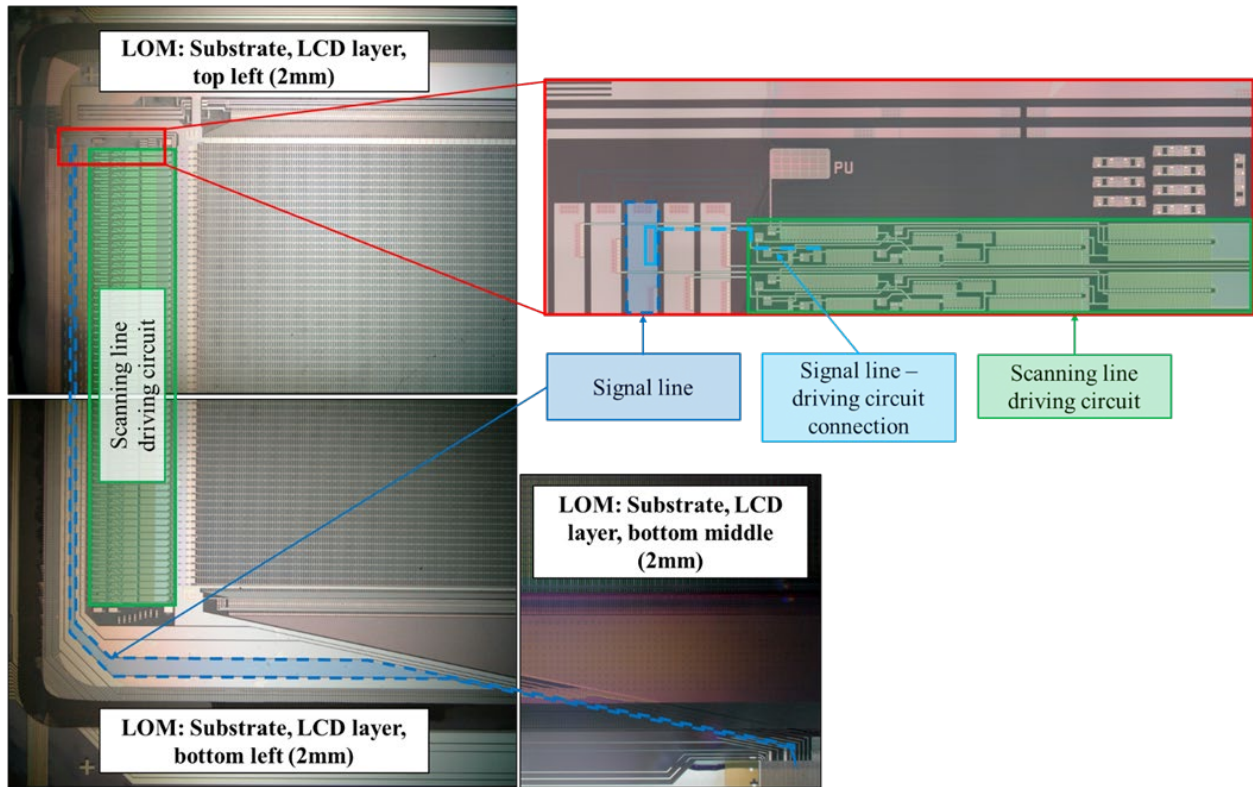

192. BOE display panels and modules, including, for example, the LCD panel used in the HP 21kd monitor, are display devices comprising a power line connected to a second terminal and the driving circuit, the power line being arranged along the one side at the peripheral area and supplying a driving voltage to the driving circuit. The devices comprise a power line connected to a second terminal, as shown below:

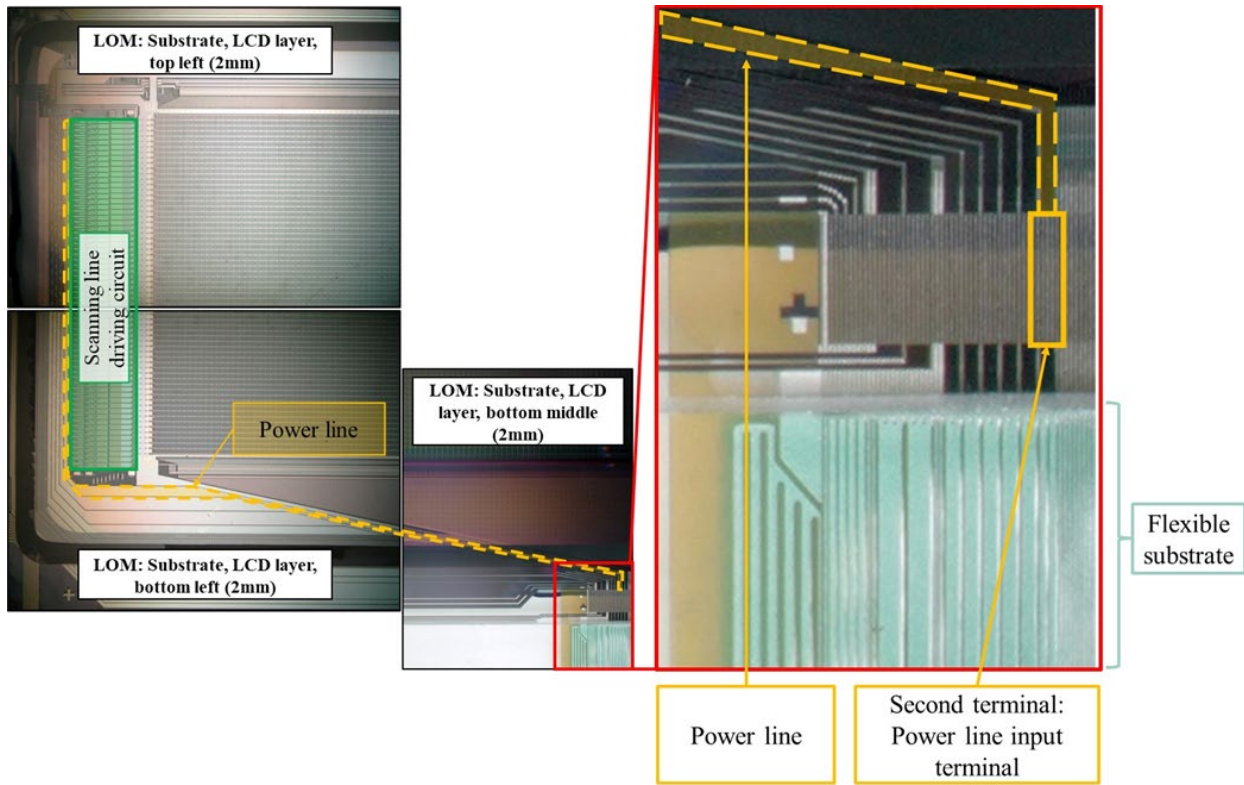

193. The devices further comprise the power line connected to the driving circuit, and the power line arranged along the one side at the peripheral area and supplying a driving voltage to the driving circuit:

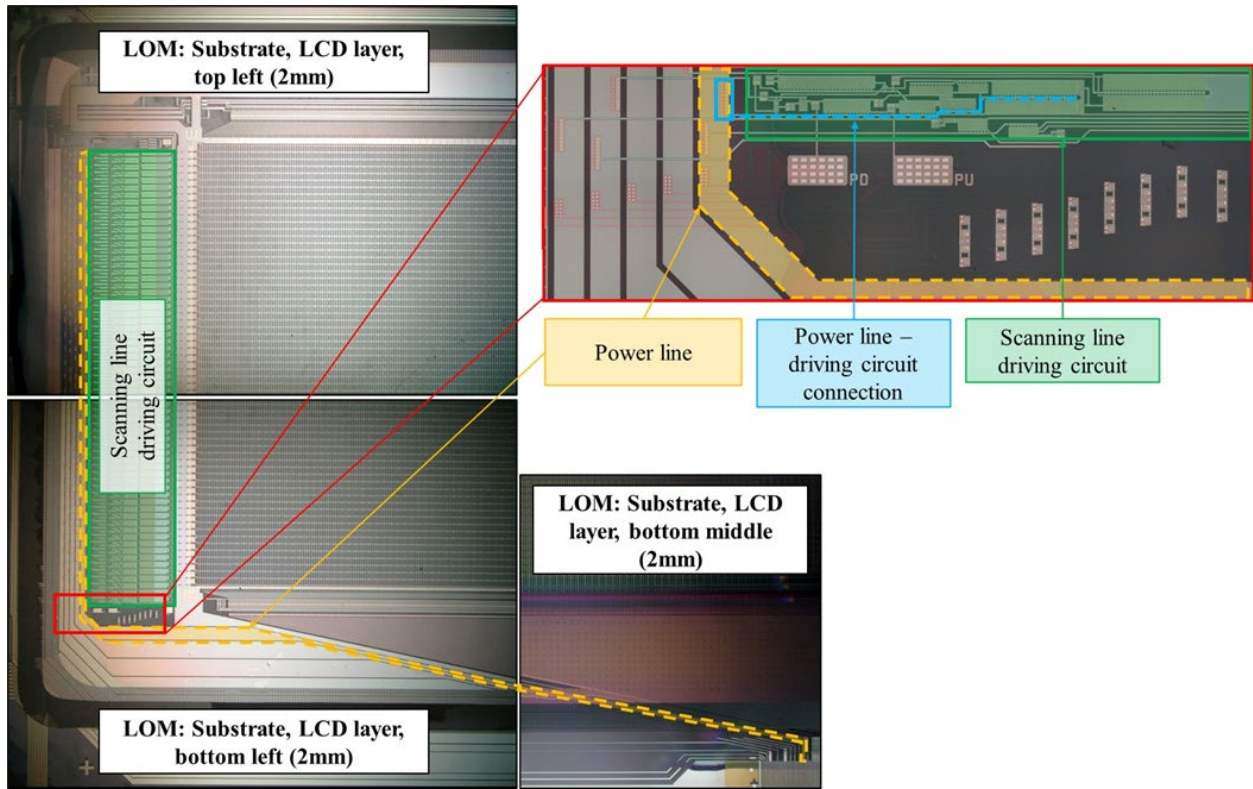

194. BOE display panels and modules, including, for example, the LCD panel used in the HP 21kd monitor, are display devices comprising a first protective circuit

arranged at the first corner and connected to the signal line at the first corner:

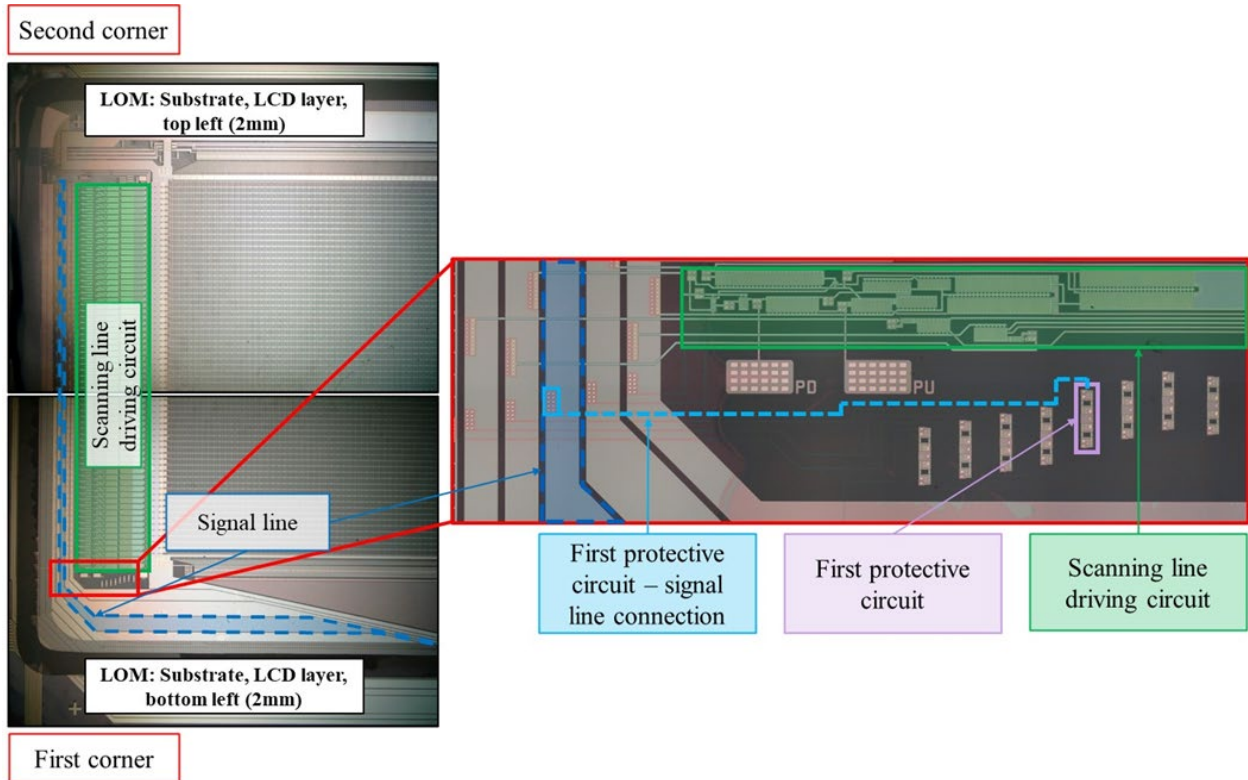

195. On information and belief, the first protective circuit is a diode ring protection circuit:

First Protective Circuit – Detail

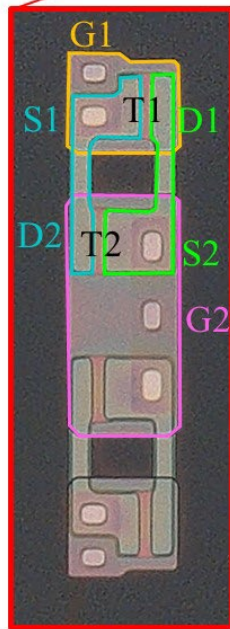
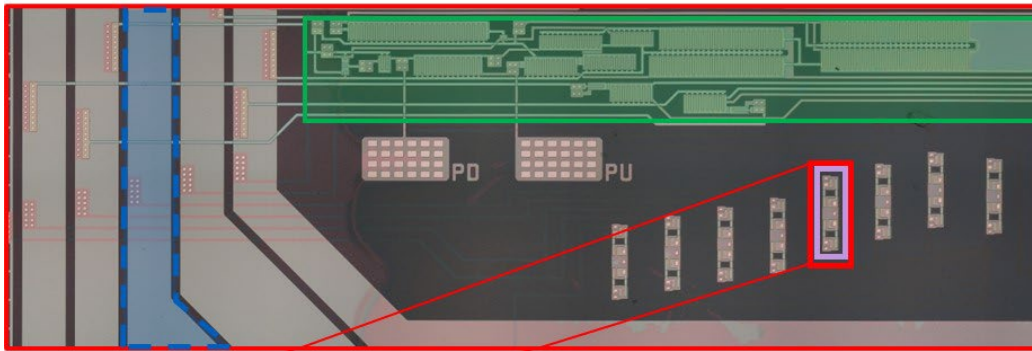

Diode Ring Protection Circuit

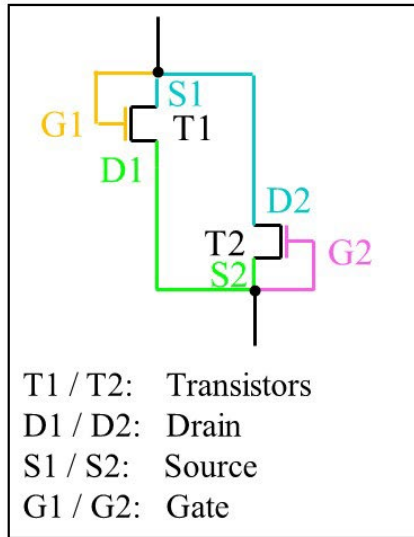

196. BOE display panels and modules, including, for example, the LCD panel used in the HP 21kd monitor, are display devices comprising a second protective circuit arranged at the second corner and connected to the power line at the second corner:

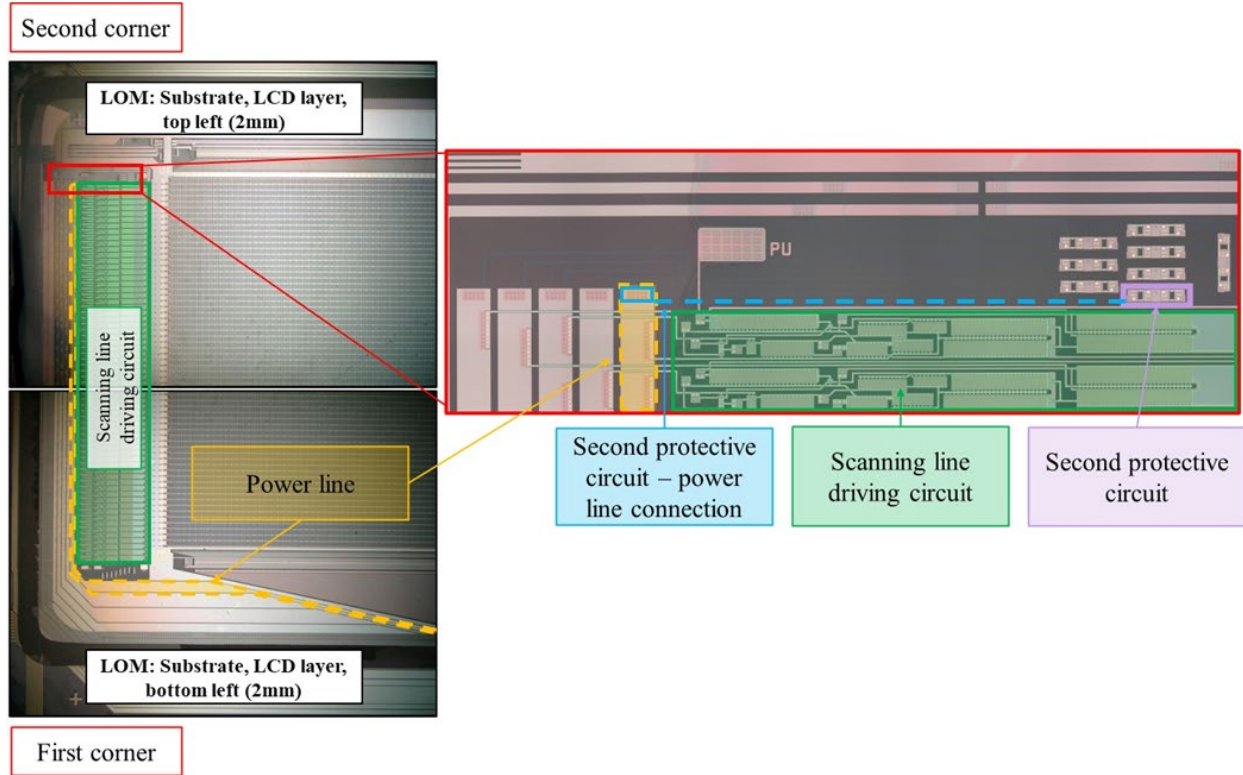

197. On information and belief, the second protective circuit is a diode ring protection circuit:

Second Protective Circuit – Detail

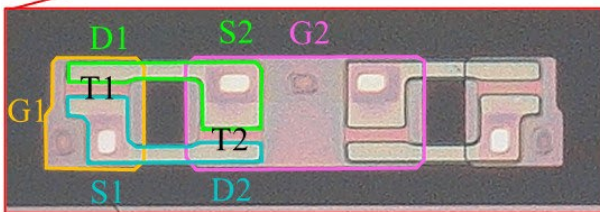
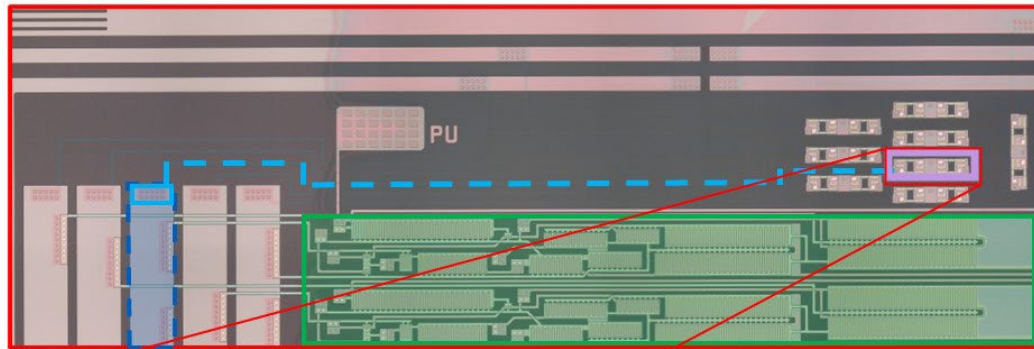

Diode Ring Protection Circuit

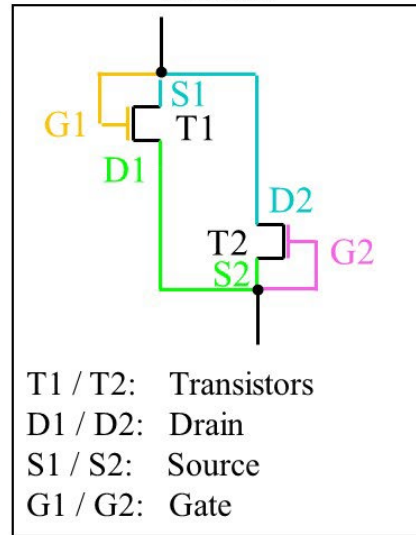

198. BOE display panels and modules, including, for example, the LCD panel used in the HP 21kd monitor, are display devices comprising the second protective circuit arranged at the second corner and connected to the power line at the second corner as shown above, and wherein the driving circuit is positioned between the first protective

circuit and the second protective circuit:

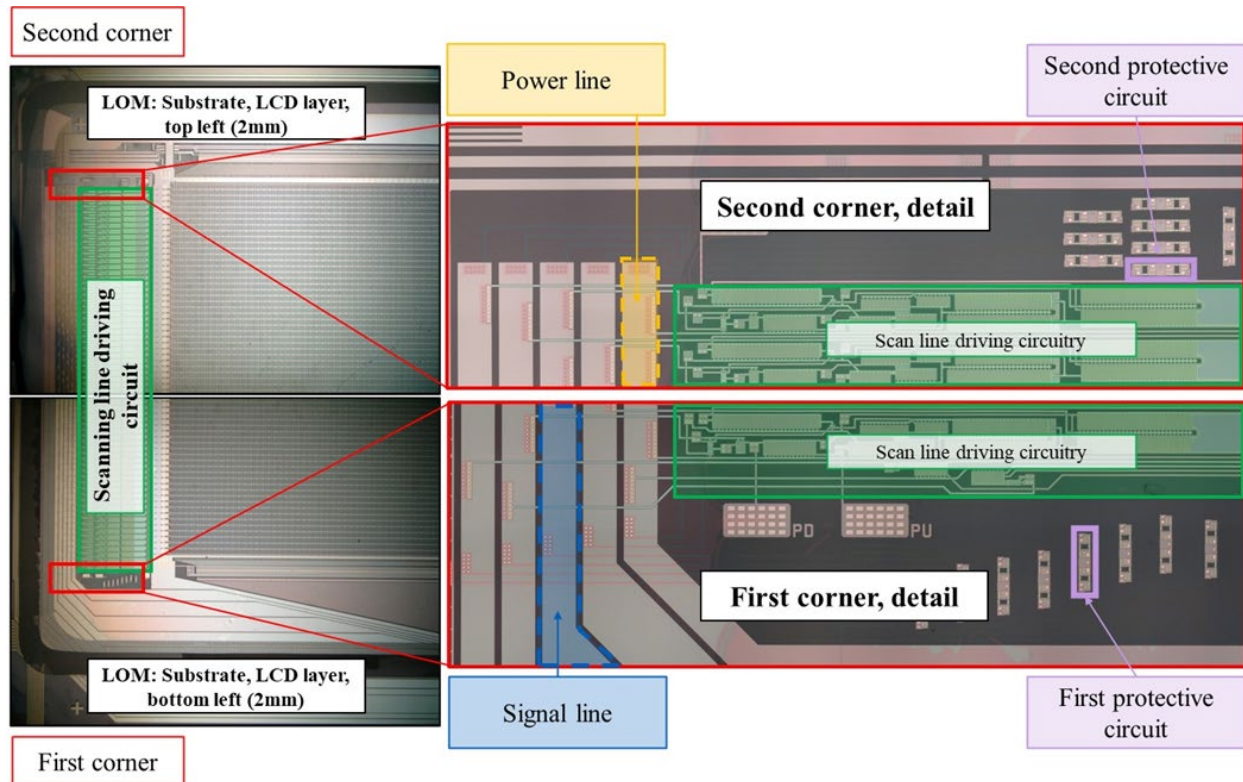

199. BOE has indirectly infringed and continues to indirectly infringe the '462 patent by actively inducing, in violation of 35 U.S.C. § 271(b), the direct infringement of the '462 patent by others in the United States, the State of Texas, and the Eastern District of Texas.

200. BOE has induced, and continues to induce, through affirmative acts, its customers and other third parties, including other importers, resellers, and end users in BOE's supply chain, to directly infringe the '462 patent by making, using, offering to sell, selling within the United States, and/or importing into the United States Accused Instrumentalities that infringe the '462 patent.

201. On information and belief, BOE actively promoted the Accused

Instrumentalities for the U.S. market, as alleged here.

202. BOE knew that its customers would offer to sell and/or sell infringing Accused Instrumentalities in the United States or cause Accused Instrumentalities to be sold in the United States, and BOE specifically intended its customers to purchase Accused Instrumentalities from BOE and offer to sell and/or sell the Accused Instrumentalities in the United States or cause Accused Instrumentalities to be sold in the United States. BOE's direct and indirect purchasers directly infringe the '462 patent by importing such Accused Instrumentalities into the United States, selling such Accused Instrumentalities in the United States, offering to sell such Accused Instrumentalities in the United States, and/or using such Accused Instrumentalities in the United States.

203. BOE has induced others' direct infringement despite actual notice that the Accused Instrumentalities infringe the '462 patent. As of at least April 8, 2021, BOE knew that the induced conduct would constitute infringement—and intended that infringement at the time of committing the aforementioned affirmative acts, such that the acts and conduct have been and continue to be committed with the specific intent to induce infringement—or deliberately avoided learning of the infringing circumstances at the time of committing these acts so as to be willfully blind to the infringement that was induced.

204. BOE has indirectly infringed and continues to indirectly infringe the '462 patent by contributing, in violation of 35 U.S.C. § 271(c), to the direct infringement of the '462 patent by others in the United States, the State of Texas, and the Eastern District of Texas, specifically, by offering to sell, selling, and/or importing into the United States

components (Accused Instrumentalities) of a claimed electronic device (*see, e.g.*, claim 7).

205. BOE's direct and indirect infringement of the '462 patent is ongoing.

206. The above-described acts of infringement have caused and continue to cause injury and damage to Longitude.

207. BOE's infringement has been and continues to be willful.

208. Longitude is entitled to recover damages sustained as a result of BOE's willful infringement in an amount subject to proof at trial, but in no event less than a reasonable royalty.

JURY TRIAL DEMANDED

209. Longitude demands a trial by jury on all claims and issues so triable.

PRAYER FOR RELIEF

WHEREFORE, Plaintiff Longitude Licensing Limited respectfully requests that this Court:

A. Enter judgment that BOE has infringed one or more claims of each of the Longitude Patents, and that such infringement was willful;

B. Enter an order, pursuant to 35 U.S.C. § 284, awarding to Plaintiff Longitude Licensing Limited monetary relief in an amount adequate to compensate for BOE's infringement of the Longitude Patents, in an amount to be determined at trial, but not less than a reasonable royalty, as well as pre- and post-judgment interest and costs and enhanced damages for BOE's willful infringement of the Longitude Patents;

C. Enter an order, pursuant to 35 U.S.C. § 285, declaring this to be an exceptional case and thereby awarding to Plaintiff Longitude Licensing Limited its reasonable attorneys' fees;

D. Enter an order awarding to Plaintiff Longitude Licensing Limited a permanent injunction enjoining BOE's ongoing patent infringement; and

E. Enter an order awarding to Plaintiff Longitude Licensing Limited such other and further relief, whether at law or in equity, that this Court seems just, equitable, and proper.

Dated: November 8, 2023

Respectfully submitted,

s/ Aaron R. Fahrenkrog

Aaron R. Fahrenkrog (admitted in this district)

MN Bar No. 0386673

AFahrenkrog@RobinsKaplan.com

Emily J. Tremblay (*pro hac vice* to be filed)

MN Bar. No. 0395003

ETremblay@RobinsKaplan.com

Samuel J. LaRoque (*pro hac vice* to be filed)

MN Bar No. 0504029

SLaRoque@RobinsKaplan.com

William R. Jones (*pro hac vice* to be filed)

MN Bar No. 0402360

WJones@RobinsKaplan.com

Navin Ramalingam (*pro hac vice* to be filed)

MN Bar No. 0402799

NRamalingam@RobinsKaplan.com

ROBINS KAPLAN LLP

2800 LaSalle Plaza

800 LaSalle Avenue

Minneapolis, MN 55402

(612) 349-8500 (telephone)
(612) 339-4181 (facsimile)

*Attorneys for Plaintiff LONGITUDE
LICENSING LIMITED*