

**IN THE UNITED STATES DISTRICT COURT  
FOR THE DISTRICT OF MASSACHUSETTS**

IOT INNOVATIONS LLC,

Plaintiff,

v.

SAVANT SYSTEMS, INC.,

Defendant.

Civil Action No.

**JURY TRIAL DEMANDED**

**COMPLAINT FOR PATENT INFRINGEMENT**

Plaintiff IoT Innovations LLC (“IoT Innovations” or “Plaintiff”) files this Complaint against Savant Systems, Inc. (“Savant Systems” or “Defendant”) alleging, based on its own knowledge as to itself and its own actions, and based on information and belief as to all other matters, as follows:

**NATURE OF THE ACTION**

1. This is a patent infringement action to stop Savant Systems’ infringement of the following United States Patents (collectively, the “Asserted Patents”) issued by the United States Patent and Trademark Office (“USPTO”), copies of which are available, respectively in the links below:

	<b>U.S. Patent No.</b>	<b>Title</b>	<b>Attached and Available At</b>
A.	7,165,224	Image Browsing And Downloading In Mobile Networks	USPTO.GOV, <a href="https://patentcenter.uspto.gov/applications/10262969">https://patentcenter.uspto.gov/applications/10262969</a> , <a href="https://image-ppubs.uspto.gov/dirsearch-public/print/downloadPdf/7165224">https://image-ppubs.uspto.gov/dirsearch-public/print/downloadPdf/7165224</a> .
B.	7,280,830	Automatic Registration Services Provided Through A Home Relationship Established Between A Device And A Local Area Network	USPTO.GOV, <a href="https://patentcenter.uspto.gov/applications/10859735">https://patentcenter.uspto.gov/applications/10859735</a> , <a href="https://image-ppubs.uspto.gov/dirsearch-public/print/downloadPdf/7280830">https://image-ppubs.uspto.gov/dirsearch-public/print/downloadPdf/7280830</a> .

	<b>U.S. Patent No.</b>	<b>Title</b>	<b>Attached and Available At</b>
C.	7,379,464	Personal Digital Gateway	USPTO.GOV, <a href="https://patentcenter.uspto.gov/applications/10306504">https://patentcenter.uspto.gov/applications/10306504</a> , <a href="https://image-ppubs.uspto.gov/dirsearch-public/print/downloadPdf/7379464">https://image-ppubs.uspto.gov/dirsearch-public/print/downloadPdf/7379464</a> .
D.	7,974,260	Method Of Transmitting Time-Critical Scheduling Information Between Single Network Devices In A Wireless Network Using Slotted Point-To-Point Links	USPTO.GOV, <a href="https://patentcenter.uspto.gov/applications/10489269">https://patentcenter.uspto.gov/applications/10489269</a> , <a href="https://image-ppubs.uspto.gov/dirsearch-public/print/downloadPdf/7974260">https://image-ppubs.uspto.gov/dirsearch-public/print/downloadPdf/7974260</a> .
E.	7,974,266	Method And Apparatus For Classifying Ip Data	USPTO.GOV, <a href="https://patentcenter.uspto.gov/applications/11778822">https://patentcenter.uspto.gov/applications/11778822</a> , <a href="https://image-ppubs.uspto.gov/dirsearch-public/print/downloadPdf/7974266">https://image-ppubs.uspto.gov/dirsearch-public/print/downloadPdf/7974266</a> .

2. IoT Innovations seeks injunctive relief and monetary damages.

### **PARTIES**

3. IoT Innovations is a limited liability company formed under the laws of Texas with a registered office address located in Austin, Texas (Travis County).

4. Savant Systems is a corporation organized under the laws of the State of Delaware and has its principal place of business located at 45 Perseverance Way Hyannis, MA 02601-1812.

5. Savant Systems may be served through its registered agent for service, Cogency Global Inc., located at 45 School Street, STE 202, Boston, MA 02108.

### **JURISDICTION AND VENUE**

6. IoT Innovations repeats and re-alleges the allegations in Paragraphs above as though fully set forth in their entirety.

7. This is an action for infringement of a United States patent arising under 35 U.S.C. §§ 271, 281, and 284–85, among others. This Court has subject matter jurisdiction of the action under 28 U.S.C. § 1331 and § 1338(a).

8. Venue is proper against Defendant in this District pursuant to 28 U.S.C. § 1400(b) and 1391(c) because it has maintained established and regular places of business in this District and has committed acts of patent infringement in the District. *See In re: Cray Inc.*, 871 F.3d 1355, 1362-1363 (Fed. Cir. 2017).

9. Defendant is subject to this Court’s specific and general personal jurisdiction under due process because of Defendant’s substantial business in this judicial District, including: (i) at least a portion of the infringements alleged herein; and (ii) regularly doing or soliciting business, engaging in other persistent courses of conduct, or deriving substantial revenue from goods and services provided to individuals in this state and in this District.

10. Specifically, Defendant intends to do and does business in, has committed acts of infringement in, and continues to commit acts of infringement in this District directly, through intermediaries, by contributing to and through inducement of third parties, and offers its products or services, including those accused of infringement here, to customers and potential customers located in this state, including in this District.

11. Defendant maintains regular and established places of business in this District.

12. Defendant offers products and services and conducts business in this District as described below.

13. Defendant ships and causes to be shipped into the District infringing products and materials instructing its customers to perform infringing activities to its employees, exclusive and

non-exclusive contractors, agents, and affiliates for installation, operation, and service at locations within this District.

14. Defendant commits acts of infringement from this District, including, but not limited to, use of the Accused Products and inducement of third parties to use the Accused Products in an infringing manner.

### THE ACCUSED PRODUCTS

15. IoT Innovations repeats and re-alleges the allegations in Paragraphs above as though fully set forth in their entirety.

16. Based upon public information, Savant Systems owns, operates, advertises, and/or controls the website and domain [www.savantsystems.com](http://www.savantsystems.com), through which it advertises, sells, offers to sell, provides and/or educates customers about their products and services.

17. Defendant uses, causes to be used, sells, offers for sale, provides, supplies, or distributes its home security and control platform and systems, including but not limited those marketed as Savant Home Systems, which include, at least, Savant Systems' Home Manager,<sup>1</sup> Smart Host, Smart Locks, Smart Lighting, Smart Fixtures, Smart Keypads, Smart Home Apps (including but not limited to the Savant App and Savant Pro App),<sup>2</sup> Smart Remotes (including but not limited to the Savant Pro Remote), and Savant Systems Server(s), and Savant Systems' encryption technologies and its cellular and Wi-Fi capabilities (including but not limited to the Savant IP Video Network), and their associated hardware and software and functionalities (the

---

<sup>1</sup> Savant Systems' Home Manager is available on Defendant's website. See SAVANT, <https://home.savant.com/>.

<sup>2</sup> Savant Systems' Smart Home Apps are available for download through mobile app providers, including but not limited to the App Store and Google Play Store. See *Savant Systems Inc.*, APP STORE, <https://apps.apple.com/us/app/savant/id1095325838>; *Savant Systems Inc.*, GOOGLE PLAY STORE, <https://play.google.com/store/apps/details?id=com.savantsystems.controlapp.pro&hl>.

“Accused Products”). *See, e.g., Figures 1-8* (below); *see also* SAVANT, <https://www.savant.com/entry-services> (**Savant Entry Services**); SAVANT, <https://www.savant.com/interfaces> (**Savant User Interfaces**); SAVANT, <https://sav-documentation.s3.amazonaws.com/Product%20Reference%20Guides/009-1712-00%20Savant%20Studio%20User%20Guide.pdf> (**Savant Studio App**); SAVANT, <https://sav-documentation.s3.amazonaws.com/Product%20User%20Guides/009-1696-01%20Savant%20Pro%20App%20Lighting%20Service%20User%20Guide.pdf> (**Savant Pro App Lighting Service**); Savant Pro App, SAVANT, <https://sav-marketing-sales.s3.amazonaws.com/public/Savant%20Pro%20App%202021.pdf>; **Savant IP Video Network**, SAVANT, <https://sav-documentation.s3.amazonaws.com/Product%20Deployment%20Guides/009-1552-04%20Savant%20IP%20Video%20Network%20Configuration%20Guide.pdf>; **Savant Pro Remote User Guide**, SAVANT, <http://sav-documentation.s3.amazonaws.com/Product%20User%20Guides/009-1410-04%20Pro%20Remote%20User%20Guide.pdf>; **Savant Door Locks**, CENTRAL COAST AV, <https://www.centralcoastav.com/savant-smart-home-demos-tutorials/savant-door-locks>; **Savant Ecosystem**, THE BIG CORP.COM, <https://thebigcorp.com/wp-content/uploads/2021/08/Savant-Ecosystem.pdf>; *see also* **Savant Pro App**, SAVANT, <https://sav-documentation.s3.amazonaws.com/Product%20User%20Guides/009-1838-05%20Savant%20Pro%20App%20User%20Guide%20%5BVersion%209.4%20and%20Higher%5D.pdf>; and SAVANT, [https://store.savant.com/DefaultStore/ccrz\\_ProductDetails?viewState=DetailView&sku=DMX-DRIVER3-00#](https://store.savant.com/DefaultStore/ccrz_ProductDetails?viewState=DetailView&sku=DMX-DRIVER3-00#).

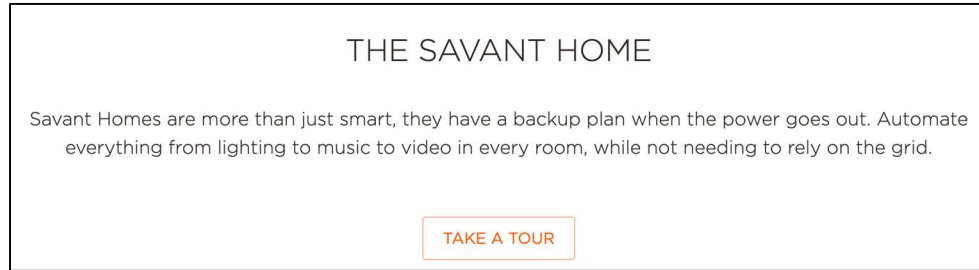

**Figure 1**

Source: SAVANT, <https://www.savant.com/>.

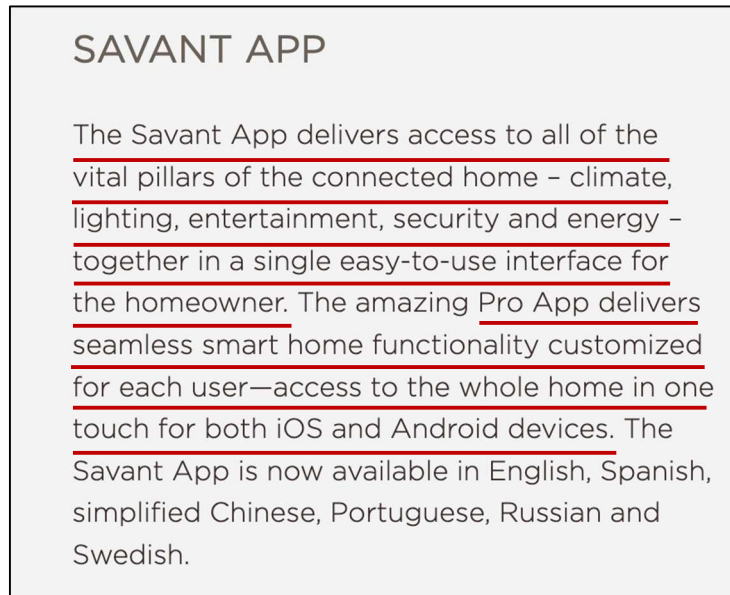

**Figure 2**

Source: SAVANT, <https://www.savant.com/case-studies/farmhouse>.

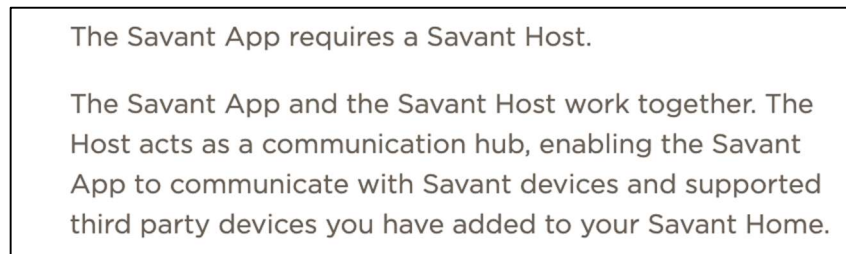

**Figure 3**

Source: SAVANT, [https://support.savant.com/help/articles/en\\_US/Support\\_Article/What-is-a-Savant-Host](https://support.savant.com/help/articles/en_US/Support_Article/What-is-a-Savant-Host).

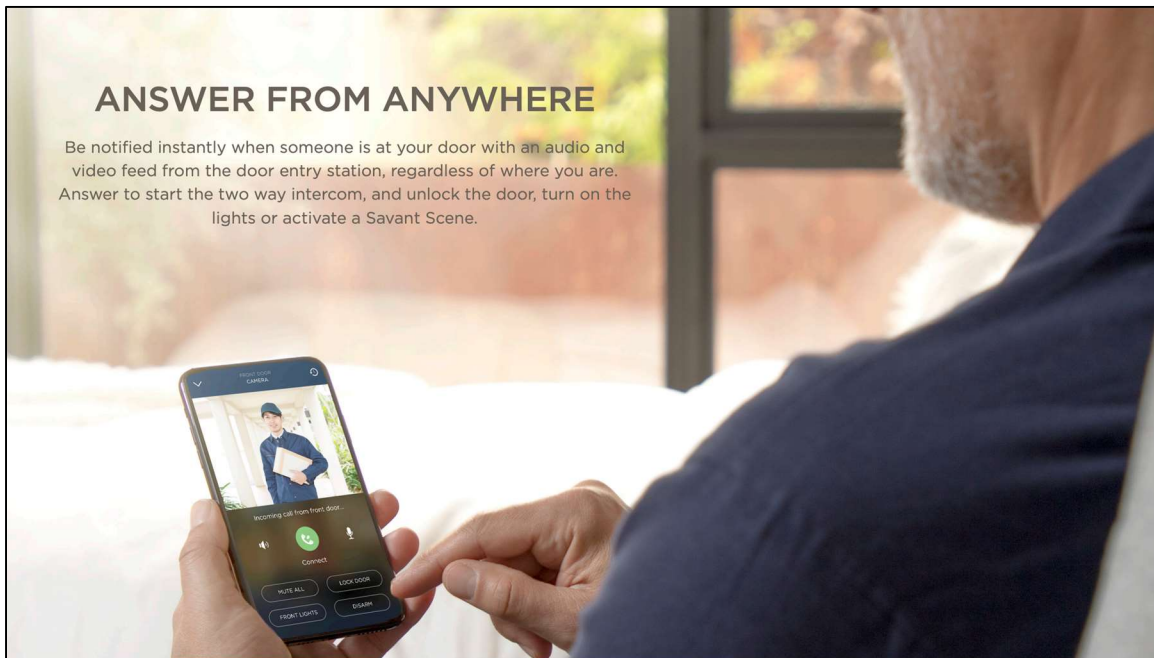

**Figure 4**

Source: SAVANT,

<https://cdn.savant.com/docs/brochures/Savant+Entry+Services+Brochure+2021-01.pdf>, at p. 3.

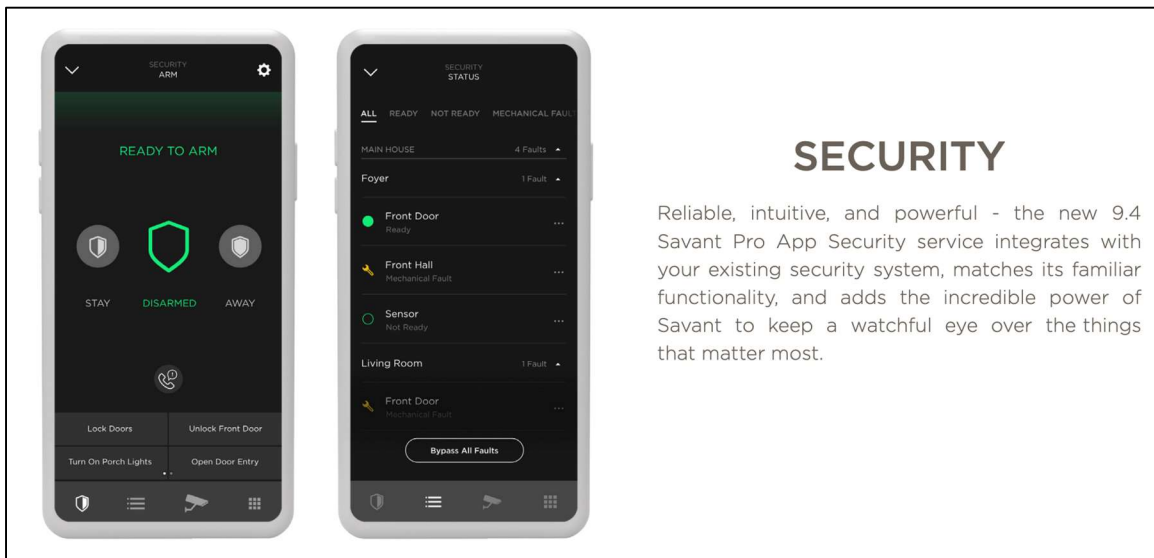
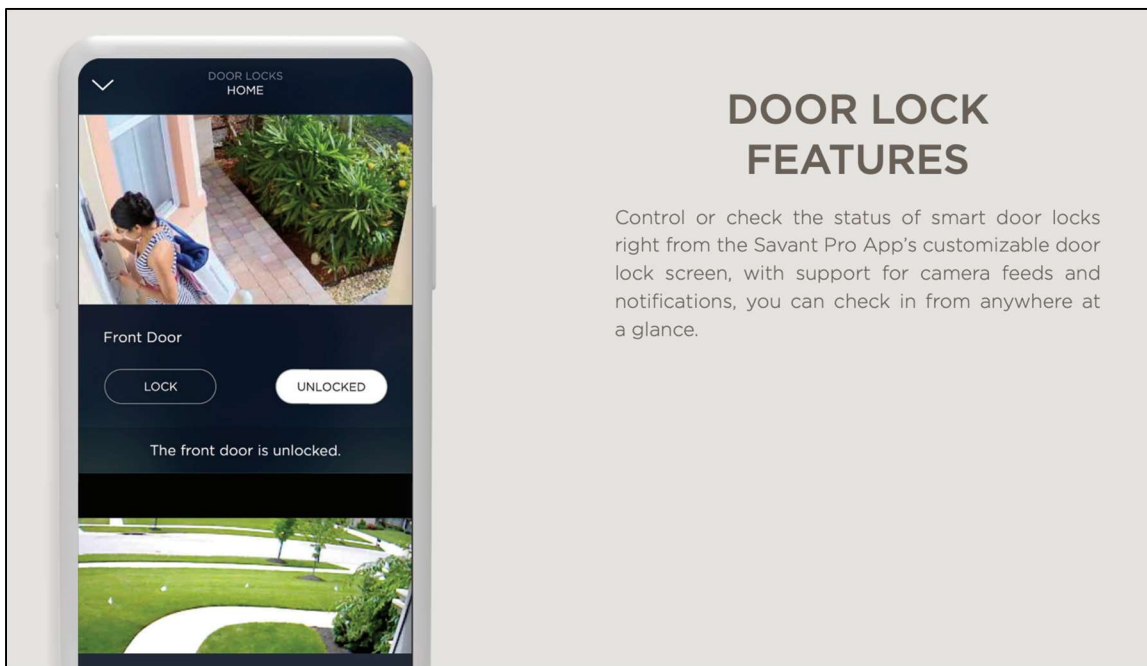

**Figure 5**

Source: SAVANT,

<https://cdn.savant.com/docs/brochures/Savant+Entry+Services+Brochure+2021-01.pdf>, at p. 5.





## DOOR LOCK FEATURES

Control or check the status of smart door locks right from the Savant Pro App's customizable door lock screen, with support for camera feeds and notifications, you can check in from anywhere at a glance.

**Figure 6**

Source: SAVANT,

<https://cdn.savant.com/docs/brochures/Savant+Entry+Services+Brochure+2021-01.pdf>, at p. 4.

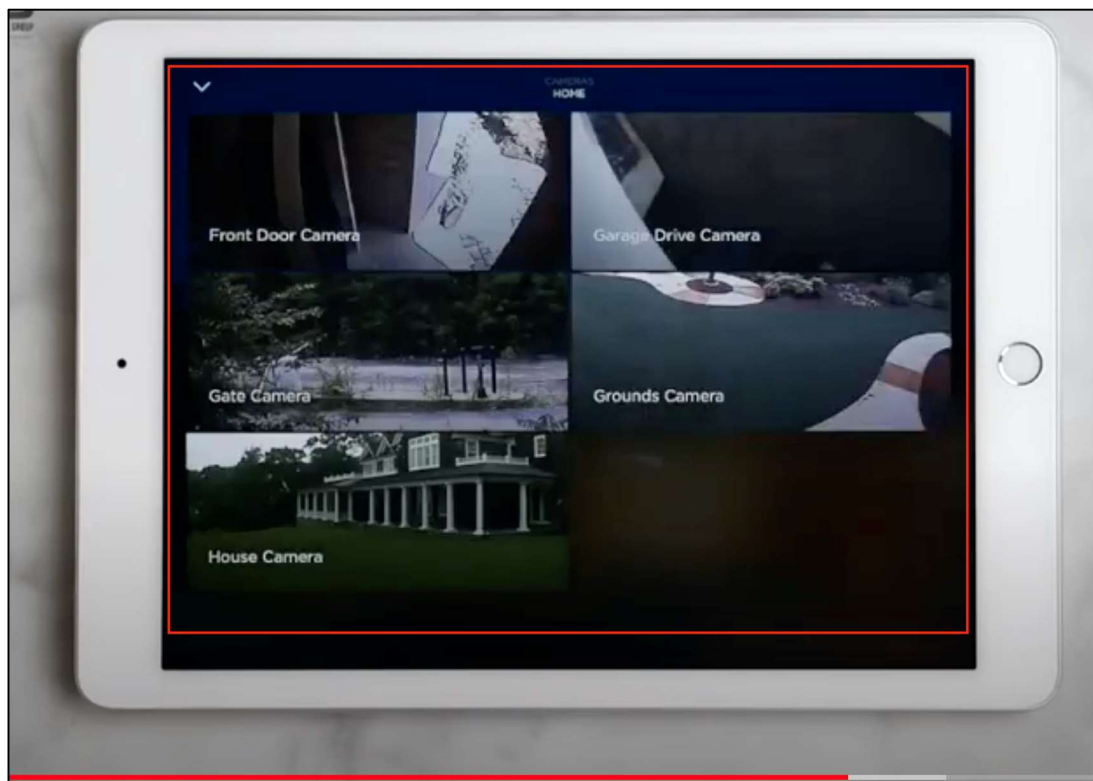

**Figure 7**

Source: YOUTUBE, <https://youtu.be/-B9hEkfjoG8?t=1247>.



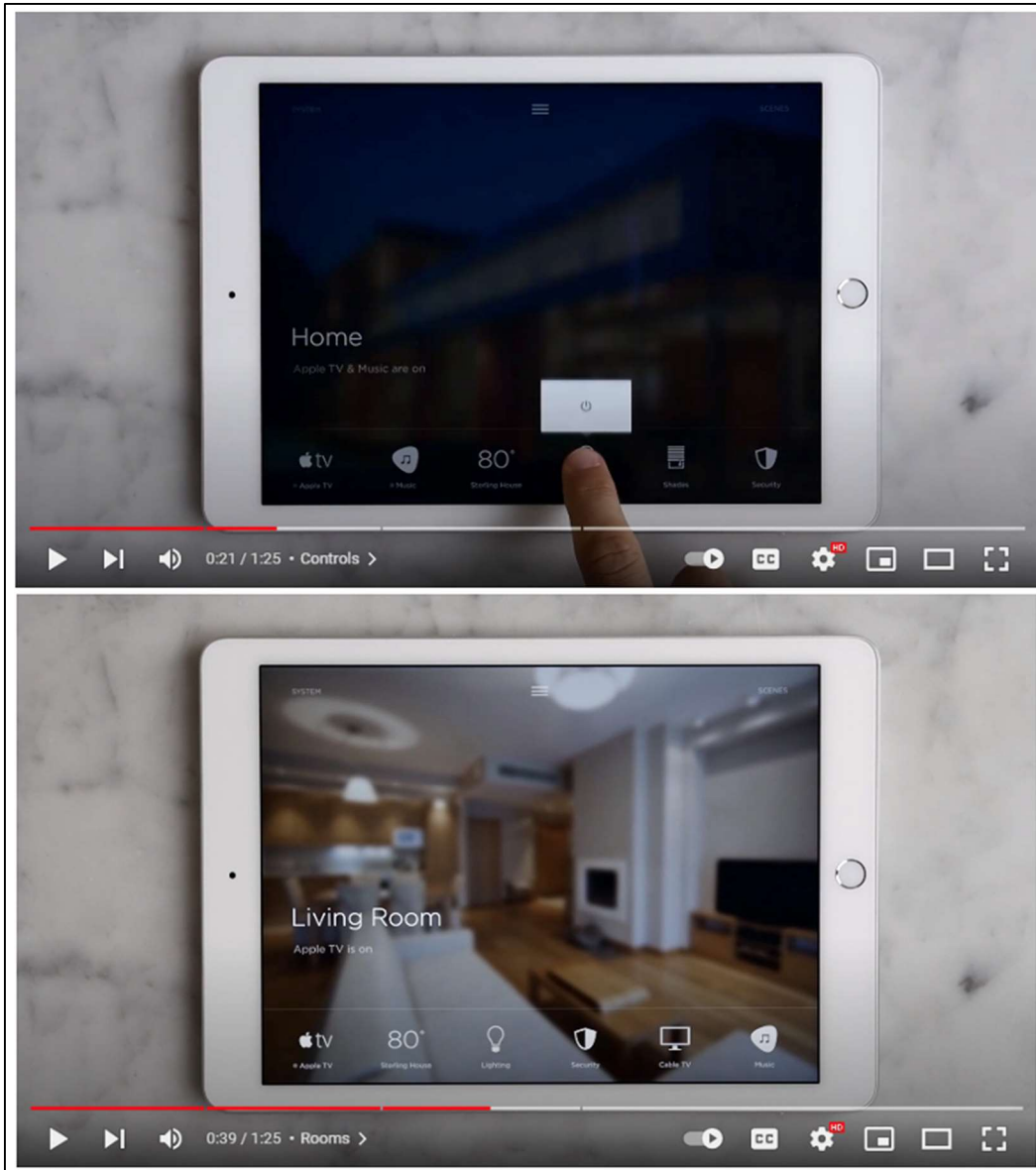

**Figure 8**

Source: YOUTUBE, <https://www.youtube.com/watch?v=dtzE9kF0zJA>.

18. Defendant also instructs its customers, agents, employees, and affiliates regarding how to use the Accused Products for home security and control. *See, e.g.*, Savant Pro Remote User Guide, SAVANT, <https://sav-documentation.s3.amazonaws.com/Product%20User%20Guides/009-1410-06%20Savant%20Pro%20Remote%20User%20Guide.pdf>; Savant Quick Reference Guide, SAVANT, [Page |9](https://sav-documentation.s3.amazonaws.com/Product%20QRGs/009-2065-</a></p></div><div data-bbox=)

[01%20Savant%20Touch%208%20Inch%20Control%20Screen%20V2%20QRG.pdf](https://cdn.savant.com/docs/brochures/Savant+Entry+Services+Brochure+2021-01.pdf); SAVANT, <https://cdn.savant.com/docs/brochures/Savant+Entry+Services+Brochure+2021-01.pdf>; SAVANT, <https://sav-documentation.s3.amazonaws.com/Product%20Programming%20Guides/009-1810-00%20Savant%20Lighting%20and%20Keypad%20Programming%20Guide.pdf>; SAVANT, [https://support.savant.com/help/articles/en\\_US/Support\\_Article/How-do-I-add-Savant-Devices](https://support.savant.com/help/articles/en_US/Support_Article/How-do-I-add-Savant-Devices); Savant Entry Services, SAVANT, [https://sav-marketing-sales.s3.amazonaws.com/public/Savant-Entry-Services-6x9\\_DIGITAL.pdf](https://sav-marketing-sales.s3.amazonaws.com/public/Savant-Entry-Services-6x9_DIGITAL.pdf); SAVANT, <https://www.savant.com/case-studies/farmhouse>; and Savant Pro App, ELEVATE INTEGRATION, [https://elevatedintegration.com/wp-content/uploads/2019/06/Savant\\_Pro\\_App\\_Guide.pdf](https://elevatedintegration.com/wp-content/uploads/2019/06/Savant_Pro_App_Guide.pdf); SAVANT, [https://support.savant.com/help/articles/en\\_US/Support\\_Article/Network-Troubleshooting-Guide](https://support.savant.com/help/articles/en_US/Support_Article/Network-Troubleshooting-Guide); SAVANT, [https://support.savant.com/help/articles/en\\_US/Support\\_Article/What-is-a-Savant-Host](https://support.savant.com/help/articles/en_US/Support_Article/What-is-a-Savant-Host).

19. For these reasons and the additional reasons detailed below, the Accused Products practice at least one claim of each of the Asserted Patents.

**COUNT I: INFRINGEMENT OF U.S. PATENT NO. 7,165,224**

20. Plaintiff repeats and re-alleges the allegations in the Paragraphs above as though fully set forth in their entirety.

21. The USPTO duly issued U.S. Patent No. 7,165,224 (hereinafter, the “’224 patent”) on January 16, 2007, after full and fair examination of Application No. 10/262,969, which was filed on October 3, 2002. *See* ’224 patent at p. 1.

22. IoT Innovations owns all substantial rights, interest, and title in and to the ’224 patent, including the sole and exclusive right to prosecute this action and enforce the ’224 patent against infringers and to collect damages for all relevant times.

23. The claims of the '224 patent are not directed to an abstract idea and are not limited to well-understood, routine, or conventional activity. Rather, the claimed inventions include inventive components that improve upon the function and operation of image management in a mobile network.

24. The written description of the '224 patent describes in technical detail each limitation of the claims, allowing a skilled artisan to understand the scope of the claims and how the non-conventional and non-generic combination of claim limitations is patently distinct from and improved upon what may have been considered conventional or generic in the art at the time of the invention.

25. Defendant has directly infringed one or more claims of the '224 patent by using, providing, supplying, or distributing the Accused Products.

26. Defendant has directly infringed and continues to infringe, either literally or under the doctrine of equivalents, at least claim 1 of the '224 patent.

27. For example, Defendant, through the use and provision of the Accused Products, performs a method of viewing an image on a mobile device, the method comprising the steps of storing in the mobile device a miniaturized version of an image being stored in the mobile device; transferring the image to an external storage device; deleting the image from the mobile device; detecting selection of the miniaturized version of the image; in response to detecting selection of the miniaturized version of the image, sending via a wireless communication network a first message requesting transfer of the image to the mobile device; and receiving a second message via the wireless communication network transferring the image to the mobile device. *See* **Figures 9-12** (below); *see also* SAVANT, <https://www.savant.com/entry-services>; SAVANT,

<https://cdn.savant.com/docs/brochures/Savant+Entry+Services+Brochure+2021-01.pdf>; SAVANT,  
<https://www.savant.com/eula>; YOUTUBE, <https://www.youtube.com/watch?v=-B9hEkfjoG8>.

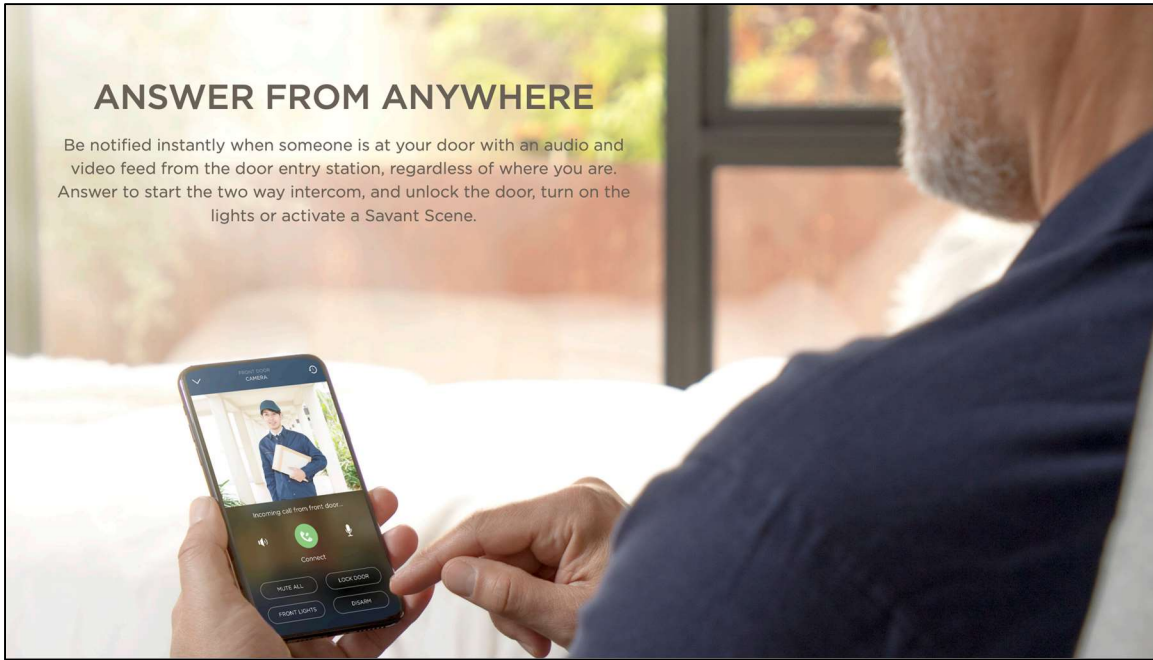

**Figure 9**

Source: SAVANT,

<https://cdn.savant.com/docs/brochures/Savant+Entry+Services+Brochure+2021-01.pdf>, at p. 3.

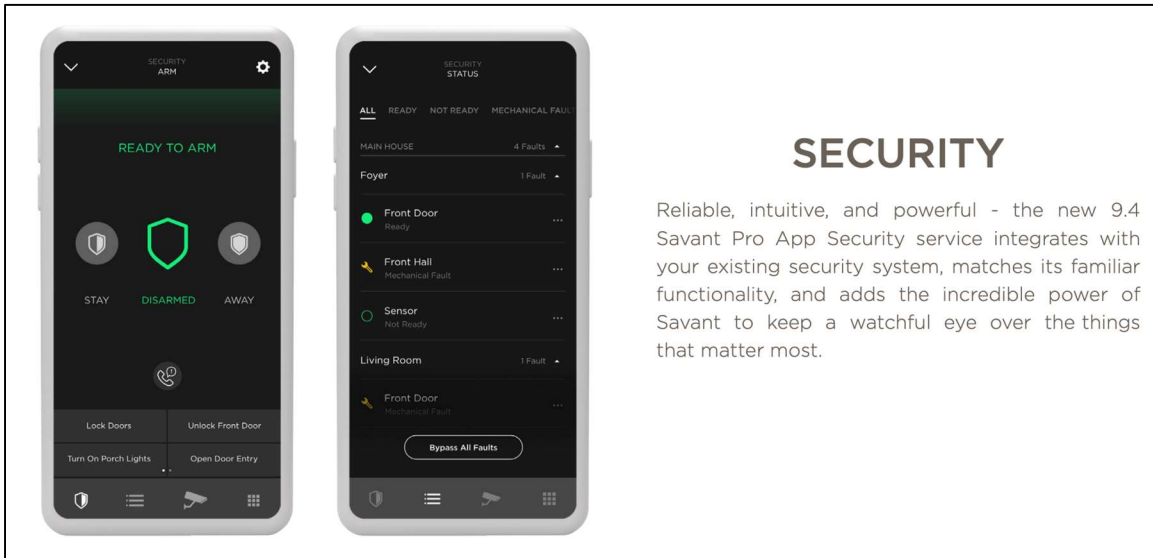

**Figure 10**

Source: SAVANT,

<https://cdn.savant.com/docs/brochures/Savant+Entry+Services+Brochure+2021-01.pdf>, at p. 5.

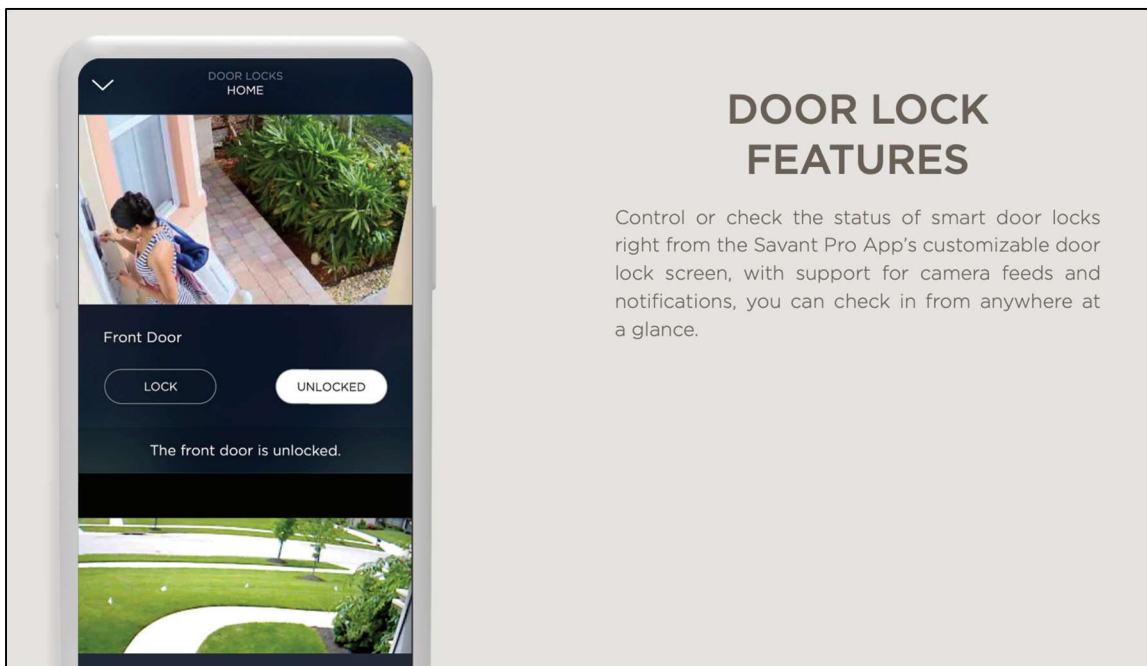

## DOOR LOCK FEATURES

Control or check the status of smart door locks right from the Savant Pro App's customizable door lock screen, with support for camera feeds and notifications, you can check in from anywhere at a glance.

**Figure 11**

Source: SAVANT,

<https://cdn.savant.com/docs/brochures/Savant+Entry+Services+Brochure+2021-01.pdf>, at p. 4.

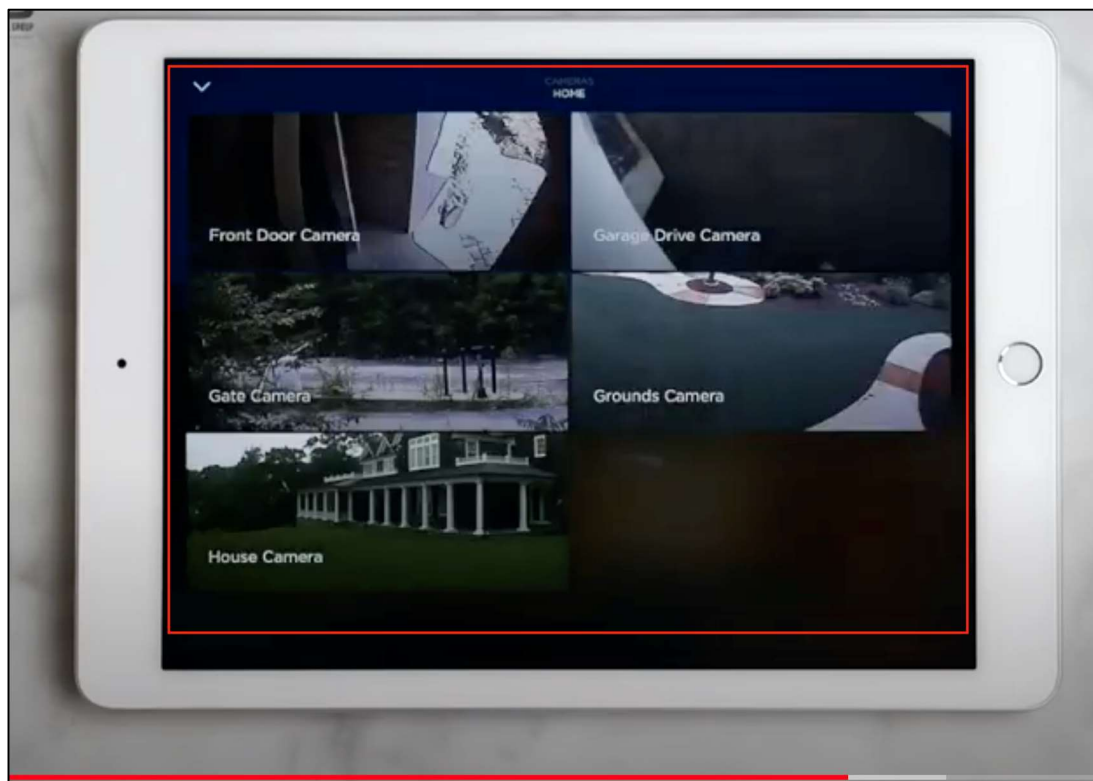

**Figure 12**

Source: YOUTUBE, <https://youtu.be/-B9hEkfjoG8?t=1247>.

28. Since at least the time of receiving the original complaint in this action, Defendant has also indirectly infringed the '224 patent by inducing others to directly infringe the '224 patent. Defendant has induced end-users, including, but not limited to, Defendant's employees, partners, or contractors, to directly infringe, either literally or under the doctrine of equivalents, the '224 patent by providing or requiring use of the Accused Products. Defendant took active steps, directly or through contractual relationships with others, with the specific intent to cause them to use the Accused Products in a manner that infringes one or more claims of the '224 patent, including, for example, claim 1 of the '224 patent. Such steps by Defendant included, among other things, advising or directing personnel, contractors, or end-users to use the Accused Products in an infringing manner; advertising and promoting the use of the Accused Products in an infringing manner; or distributing instructions that guide users to use the Accused Products in an infringing manner. Defendant is performing these steps, which constitute induced infringement with the knowledge of the '224 patent and with the knowledge that the induced acts constitute infringement. Defendant is aware that the normal and customary use of the Accused Products by others would infringe the '224 patent. Defendant's inducement is ongoing. *See, e.g.,* SAVANT, <https://www.savant.com/case-studies/farmhouse>; Savant Product User Guide, SAVANT, <https://s3.amazonaws.com/Product%20User%20Guides/009-1838-05%20Savant%20Pro%20App%20User%20Guide%20%5BVersion%209.4%20and%20Higher%5D.pdf>; Savant Entry Services, SAVANT, [https://sav-marketing-sales.s3.amazonaws.com/public/Savant-Entry-Services-6x9\\_DIGITAL.pdf](https://sav-marketing-sales.s3.amazonaws.com/public/Savant-Entry-Services-6x9_DIGITAL.pdf).

29. Defendant has also indirectly infringed by contributing to the infringement of the '224 patent. Defendant has contributed to the direct infringement of the '224 patent by its personnel, contractors, and customers. The Accused Products have special features that are specially

designed to be used in an infringing way and that have no substantial uses other than ones that infringe one or more claims of the '224 patent, including, for example, claim 1 of the '224 patent. The special features constitute a material part of the invention of one or more of the claims of the '224 patent and are not staple articles of commerce suitable for substantial non-infringing use. Defendant's contributory infringement is ongoing. *See, e.g.,* SAVANT, <https://www.savant.com/case-studies/farmhouse>; Savant Product User Guide, SAVANT, <https://sav-documentation.s3.amazonaws.com/Product%20User%20Guides/009-1838-05%20Savant%20Pro%20App%20User%20Guide%20%5BVersion%209.4%20and%20Higher%5D.pdf>; Savant Entry Services, SAVANT, [https://sav-marketing-sales.s3.amazonaws.com/public/Savant-Entry-Services-6x9\\_DIGITAL.pdf](https://sav-marketing-sales.s3.amazonaws.com/public/Savant-Entry-Services-6x9_DIGITAL.pdf).

30. Defendant had knowledge of the '224 patent at least as of the date when it was notified of the filing of this action.

31. Furthermore, on information and belief, Defendant has a policy or practice of not reviewing the patents of others, including instructing its employees to not review the patents of others, and thus have been willfully blind of IoT Innovations' patent rights.

32. Defendant's actions are at least objectively reckless as to the risk of infringing a valid patent and this objective risk was either known or should have been known by Defendant.

33. Defendant's direct infringement of one or more claims of the '224 patent is, has been, and continues to be willful, intentional, deliberate, or in conscious disregard of IoT Innovations' rights under the patent.

34. IoT Innovations or its predecessors-in-interest have satisfied all statutory obligations required to collect pre-filing damages for the full period allowed by law for infringement of one or more claims of the '224 patent.



35. IoT Innovations has been damaged as a result of the infringing conduct by Defendant alleged above. Thus, Defendant is liable to IoT Innovations in an amount that compensates it for such infringements, which by law cannot be less than a reasonable royalty, together with interest and costs as fixed by this Court under 35 U.S.C. § 284.

36. IoT Innovations has suffered irreparable harm, through its loss of market share and goodwill, for which there is no adequate remedy at law. IoT Innovations has and will continue to suffer this harm by virtue of Defendant's infringement of the '224 patent. Defendant's actions have interfered with and will interfere with Plaintiff's ability to license technology. The balance of hardships favors IoT Innovations' ability to commercialize its own ideas and technology. The public interest in allowing IoT Innovations to enforce its right to exclude outweighs other public interests, which supports injunctive relief in this case.

**COUNT II: INFRINGEMENT OF U.S. PATENT NO. 7,280,830**

37. Plaintiff repeats and re-alleges the allegations in the Paragraphs above as though fully set forth in their entirety.

38. The USPTO duly issued U.S. Patent No. 7,280,830 (hereinafter, the "'830 patent") on October 9, 2007 after full and fair examination of Application No. 10/859,735 which was filed on June 2, 2004. *See* '830 patent at p. 1.

39. IoT Innovations owns all substantial rights, interest, and title in and to the '830 patent, including the sole and exclusive right to prosecute this action and enforce the '830 patent against infringers and to collect damages for all relevant times.

40. The claims of the '830 patent are not directed to an abstract idea and are not limited to well-understood, routine, or conventional activity. Rather, the claimed inventions include

inventive components that improve upon the function and operation of automatic registration of a new device through the establishment of a home relationship with a network server.

41. The written description of the '830 patent describes in technical detail each limitation of the claims, allowing a skilled artisan to understand the scope of the claims and how the non-conventional and non-generic combination of claim limitations is patently distinct from and improved upon what may have been considered conventional or generic in the art at the time of the invention.

42. Defendant has directly infringed one or more claims of the '830 patent by using, providing, supplying, or distributing the Accused Products.

43. Defendant has directly infringed, either literally or under the doctrine of equivalents, at least claim 1 of the '830 patent.

44. For example, Defendant, using the Accused Products and their associated hardware and software and functionalities, performs a method for automatic registration of a new wireless device with a registration server, comprising: establishing a home relationship between the new wireless device and a network server, such that no additional configuration is required by a user of the new device to communicate over a network once the relationship is established, wherein establishing a home relationship includes, determining at the network server, that the wireless device is an owned device, wherein the owned device is previously known to the network server; automatically obtaining registration information for the new device; establishing a connection between a registration server and the network server; and sending the registration information from the network server to the registration server. *See, e.g., Figures 13-15; see also* SAVANT, <https://sav-documentation.s3.amazonaws.com/Product%20Programming%20Guides/009-1810-00%20Savant%20Lighting%20and%20Keypad%20Programming%20Guide.pdf>.



**Figure 13**

Source: SAVANT, <https://sav-documentation.s3.amazonaws.com/Product%20Programming%20Guides/009-1810-00%20Savant%20Lighting%20and%20Keypad%20Programming%20Guide.pdf>.

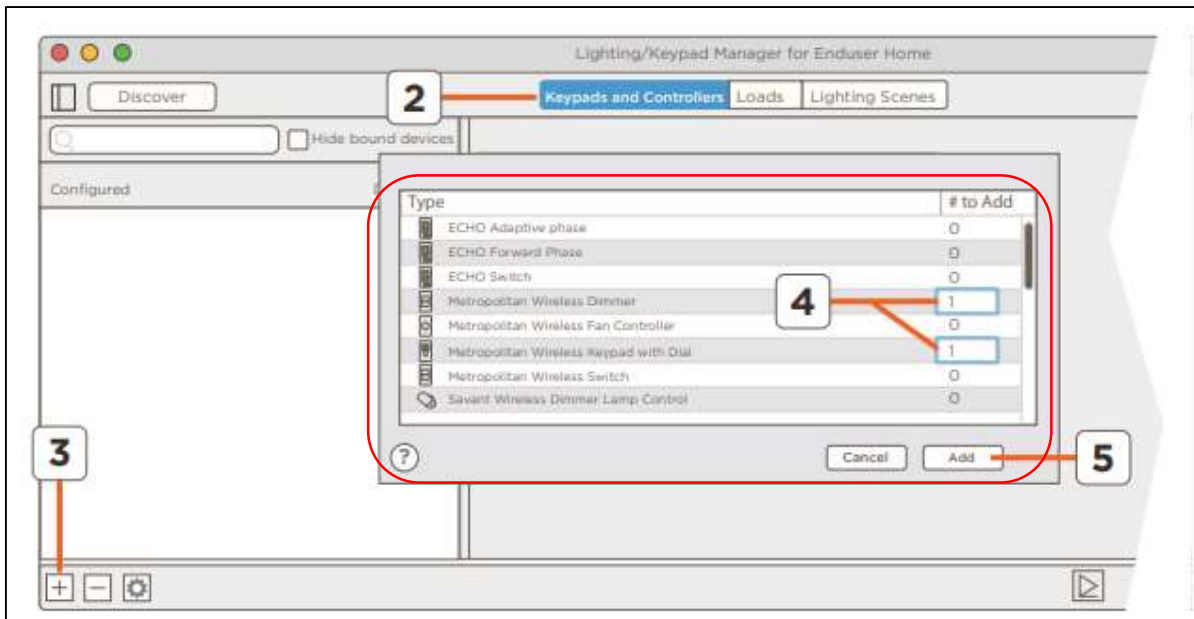

**Figure 14**

Source: SAVANT, <https://sav-documentation.s3.amazonaws.com/Product%20Programming%20Guides/009-1810-00%20Savant%20Lighting%20and%20Keypad%20Programming%20Guide.pdf>.

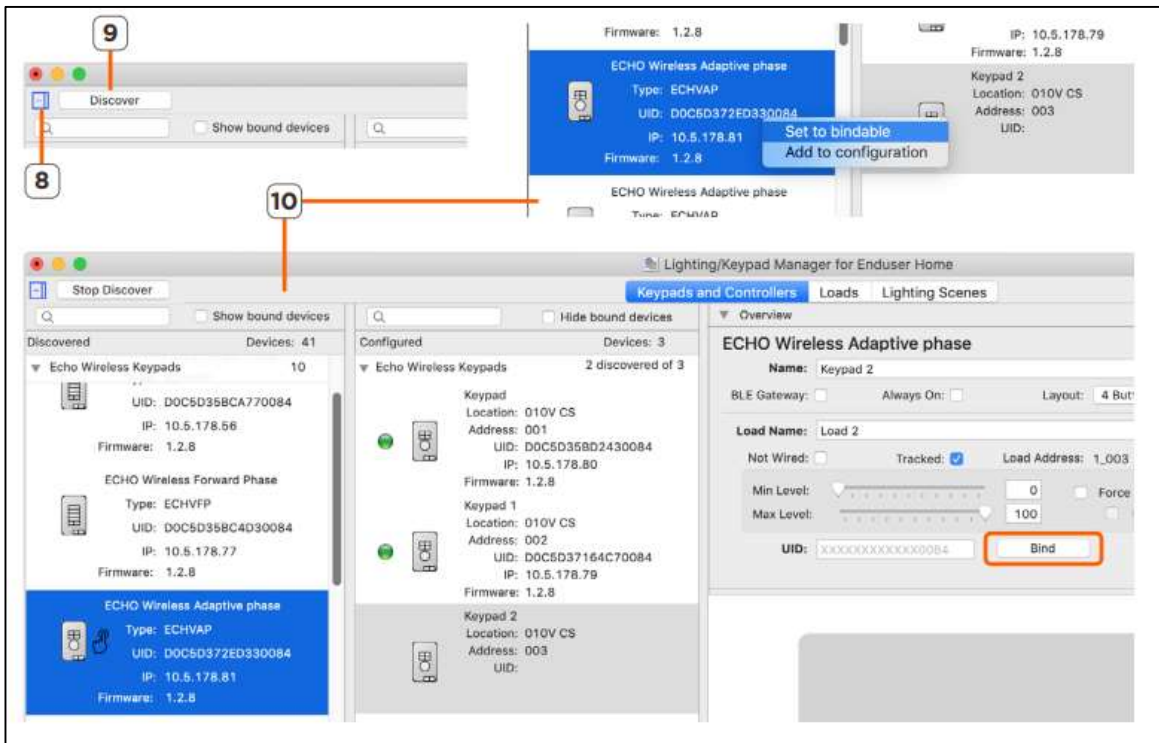

**Figure 15**

Source: SAVANT, <https://sav- documentation.s3.amazonaws.com/Product%20Programming%20Guides/009-1810-00%20Savant%20Lighting%20and%20Keypad%20Programming%20Guide.pdf>.

45. Since at least the time of receiving the original complaint in this action, Defendant has also indirectly infringed the '830 patent by inducing others to directly infringe the '830 patent. Defendant has induced end-users, including, but not limited to, Defendant's employees, partners, or contractors, to directly infringe, either literally or under the doctrine of equivalents, the '830 patent by providing or requiring use of the Accused Products. Defendant took active steps, directly or through contractual relationships with others, with the specific intent to cause them to use the Accused Products in a manner that infringes one or more claims of the '830 patent, including, for example, claim 1 of the '830 patent. Such steps by Defendant included, among other things, advising or directing personnel, contractors, or end-users to use the Accused Products in an infringing manner; advertising and promoting the use of the Accused Products in an infringing manner; or distributing instructions that guide users to use the Accused Products in an infringing

manner. Defendant is performing these steps, which constitute induced infringement with the knowledge of the '830 patent and with the knowledge that the induced acts constitute infringement. Defendant is aware that the normal and customary use of the Accused Products by others would infringe the '830 patent. Defendant's inducement is ongoing. *See, e.g.*, SAVANT, <https://sav-documentation.s3.amazonaws.com/Product%20Programming%20Guides/009-1810-00%20Savant%20Lighting%20and%20Keypad%20Programming%20Guide.pdf>; SAVANT, [https://store.savant.com/DefaultStore/ccrz\\_ProductDetails?viewState=DetailView&sku=DMX-DRIVER3-00#](https://store.savant.com/DefaultStore/ccrz_ProductDetails?viewState=DetailView&sku=DMX-DRIVER3-00#).

46. Since at least the time of receiving the original complaint in this action, Defendant has also indirectly infringed by contributing to the infringement of the '830 patent. Defendant has contributed to the direct infringement of the '830 patent by their personnel, contractors, and customers. The Accused Products have special features that are specially designed to be used in an infringing way and that have no substantial uses other than ones that infringe one or more claims of the '830 patent, including, for example, claim 1 of the '830 patent. The special features constitute a material part of the invention of one or more of the claims of the '830 patent and are not staple articles of commerce suitable for substantial non-infringing use. Defendant's contributory infringement is ongoing. *See, e.g., See, e.g.*, SAVANT, <https://sav-documentation.s3.amazonaws.com/Product%20Programming%20Guides/009-1810-00%20Savant%20Lighting%20and%20Keypad%20Programming%20Guide.pdf>; SAVANT, [https://store.savant.com/DefaultStore/ccrz\\_ProductDetails?viewState=DetailView&sku=DMX-DRIVER3-00#](https://store.savant.com/DefaultStore/ccrz_ProductDetails?viewState=DetailView&sku=DMX-DRIVER3-00#).

47. Defendant had knowledge of the '830 patent at least as of the date when they were notified of the filing of the original complaint in this action.

48. Furthermore, on information and belief, Defendant has a policy or practice of not reviewing the patents of others, including instructing its employees to not review the patents of others, and thus have been willfully blind of IoT Innovations' patent rights.

49. Defendant's actions are at least objectively reckless as to the risk of infringing a valid patent and this objective risk was either known or should have been known by Defendant.

50. Defendant's direct infringement of one or more claims of the '830 patent is, has been, and continues to be willful, intentional, deliberate, or in conscious disregard of IoT Innovations' rights under the patent.

51. IoT Innovations or its predecessors-in-interest have satisfied all statutory obligations required to collect pre-filing damages for the full period allowed by law for infringement of one or more claims of the '830 patent.

52. IoT Innovations has been damaged as a result of the infringing conduct by Defendant alleged above. Thus, Defendant is liable to IoT Innovations in an amount that compensates it for such infringements, which by law cannot be less than a reasonable royalty, together with interest and costs as fixed by this Court under 35 U.S.C. § 284.

53. IoT Innovations has suffered irreparable harm, through its loss of market share and goodwill, for which there is no adequate remedy at law. IoT Innovations has and will continue to suffer this harm by virtue of Defendant's infringement of the '830 patent. Defendant's actions have interfered with and will interfere with IoT Innovations' ability to license technology. The balance of hardships favors IoT Innovations' ability to commercialize its own ideas and technology. The public interest in allowing IoT Innovations to enforce its right to exclude outweighs other public interests, which supports injunctive relief in this case.

**COUNT III: INFRINGEMENT OF U.S. PATENT NO. 7,379,464**

54. IoT Innovations repeats and re-alleges the allegations in the Paragraphs above as though fully set forth in their entirety.

55. The USPTO duly issued U.S. Patent No. 7,379,464 (hereinafter, the “’464 patent”) on May 27, 2008, after full and fair examination of Application No. 10/306,504 which was filed on November 27, 2002. *See* ’464 patent at p. 1.

56. IoT Innovations owns all substantial rights, interest, and title in and to the ’464 patent, including the sole and exclusive right to prosecute this action and enforce it against infringers and to collect damages for all relevant times.

57. The claims of the ’464 patent are not directed to an abstract idea and are not limited to well-understood, routine, or conventional activity. Rather, the claimed inventions include inventive components that improve upon the function, operation, and security of communications devices by sharing of personalized information by providing communications infrastructures to support and capitalize on the different communications devices of the user to provide up-to-date personalized information through a digital gateway.

58. The written description of the ’464 patent describes in technical detail each limitation of the claims, allowing a skilled artisan to understand the scope of the claims and how the non-conventional and non-generic combination of claim limitations is patently distinct from and improved upon what may have been considered conventional or generic in the art at the time of the invention.

59. Defendant has directly infringed and continues to directly infringe one or more claims of the ’464 patent by making, using, selling, offering to sell, providing, supplying, or distributing



the Accused Products. For instance, Defendant has directly infringed and continues to directly infringe, either literally or under the doctrine of equivalents, at least claim 1 of the '464 patent.

60. As an example, Defendant, using the Accused Products and their associated hardware and software and functionalities, performs a method, comprising selecting a user's communications device from a plurality of communications devices to communicate data between a personal digital gateway and the selected communications device, the data associated with a common user of the personal digital gateway and of the selected communications device; storing profiles for each of the user's communications devices; retrieving a profile associated with the selected communications device; interpreting the data according to a rule-based engine to categorize the data as at least one of (1) data associated with an access agent, (2) data associated with a configuration agent, (3) data associated with a security agent, and (4) data associated with a management agent; processing the data according to an edge side assembler; and communicating the data and the profile to the selected communications device. *See, e.g., Figures 16-25; see also* SAVANT, <https://www.savant.com/interfaces>; Savant Studio App User Guide, SAVANT, <https://sav-documentation.s3.amazonaws.com/Product%20Reference%20Guides/009-1712-00%20Savant%20Studio%20User%20Guide.pdf>; and YOUTUBE, <https://www.youtube.com/watch?v=-B9hEkfjoG8>, and <https://www.youtube.com/watch?v=dtzE9kF0zJA>.

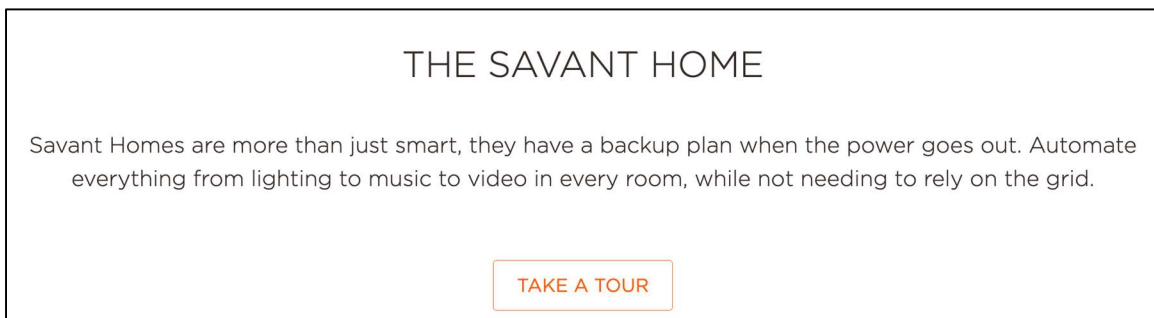

**Figure 16**

Source: SAVANT, <https://www.savant.com/>.

## SAVANT APP

The Savant App delivers access to all of the vital pillars of the connected home – climate, lighting, entertainment, security and energy – together in a single easy-to-use interface for the homeowner. The amazing Pro App delivers seamless smart home functionality customized for each user—access to the whole home in one touch for both iOS and Android devices. The Savant App is now available in English, Spanish, simplified Chinese, Portuguese, Russian and Swedish.

### **Figure 17**

Source: SAVANT, <https://www.savant.com/case-studies/farmhouse>.

The Savant App requires a Savant Host.

The Savant App and the Savant Host work together. The Host acts as a communication hub, enabling the Savant App to communicate with Savant devices and supported third party devices you have added to your Savant Home.

### **Figure 18**

Source: SAVANT, [https://support.savant.com/help/articles/en\\_US/Support\\_Article/What-is-a-Savant-Host](https://support.savant.com/help/articles/en_US/Support_Article/What-is-a-Savant-Host).

61. For instance, as one example, the Accused Products perform the step of selecting a user's communications device from a plurality of communications devices to communicate data between a personal digital gateway (e.g., Savant Host) and the selected communications device, the data associated with a common user of the personal digital gateway and of the selected communications device. *See, e.g., Figures 19-23.*

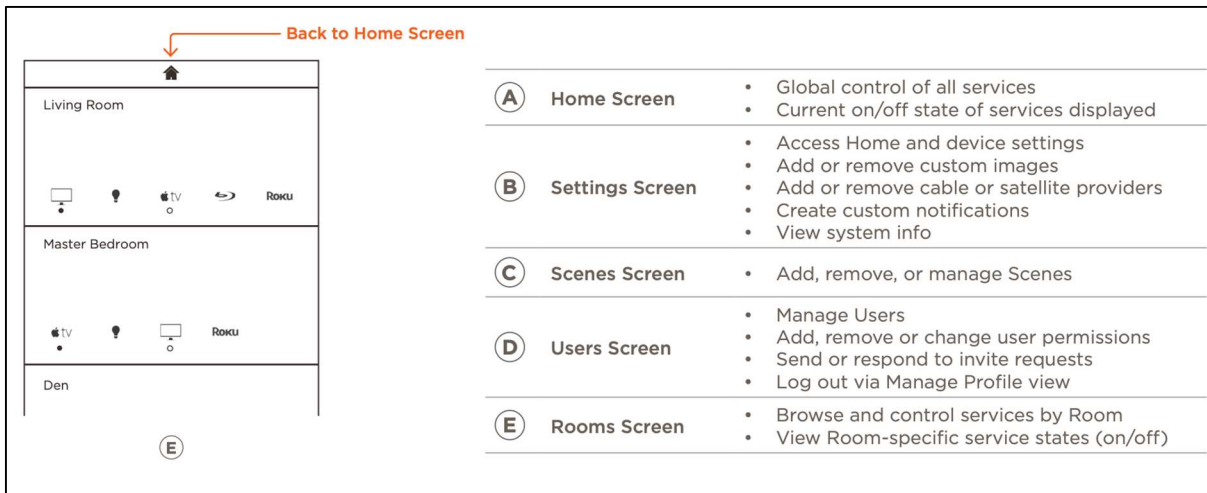

**Figure 19**

Source: Savant Product User Guide, SAVANT, <https://sav-documentation.s3.amazonaws.com/Product%20User%20Guides/009-1838-05%20Savant%20Pro%20App%20User%20Guide%20%5BVersion%209.4%20and%20Higher%5D.pdf>, at p. 15.

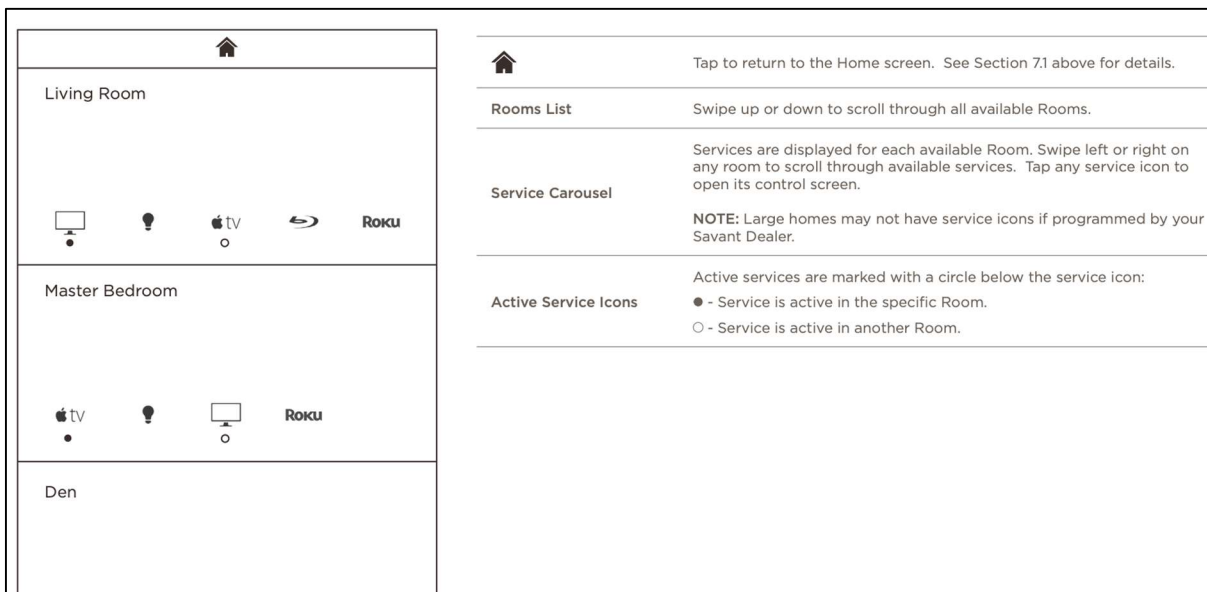

**Figure 20**

Source: Savant Product User Guide, SAVANT, <https://sav-documentation.s3.amazonaws.com/Product%20User%20Guides/009-1838-05%20Savant%20Pro%20App%20User%20Guide%20%5BVersion%209.4%20and%20Higher%5D.pdf>, at p. 17; *see also id.* at 1, 3, 4, 5, 6, 15.

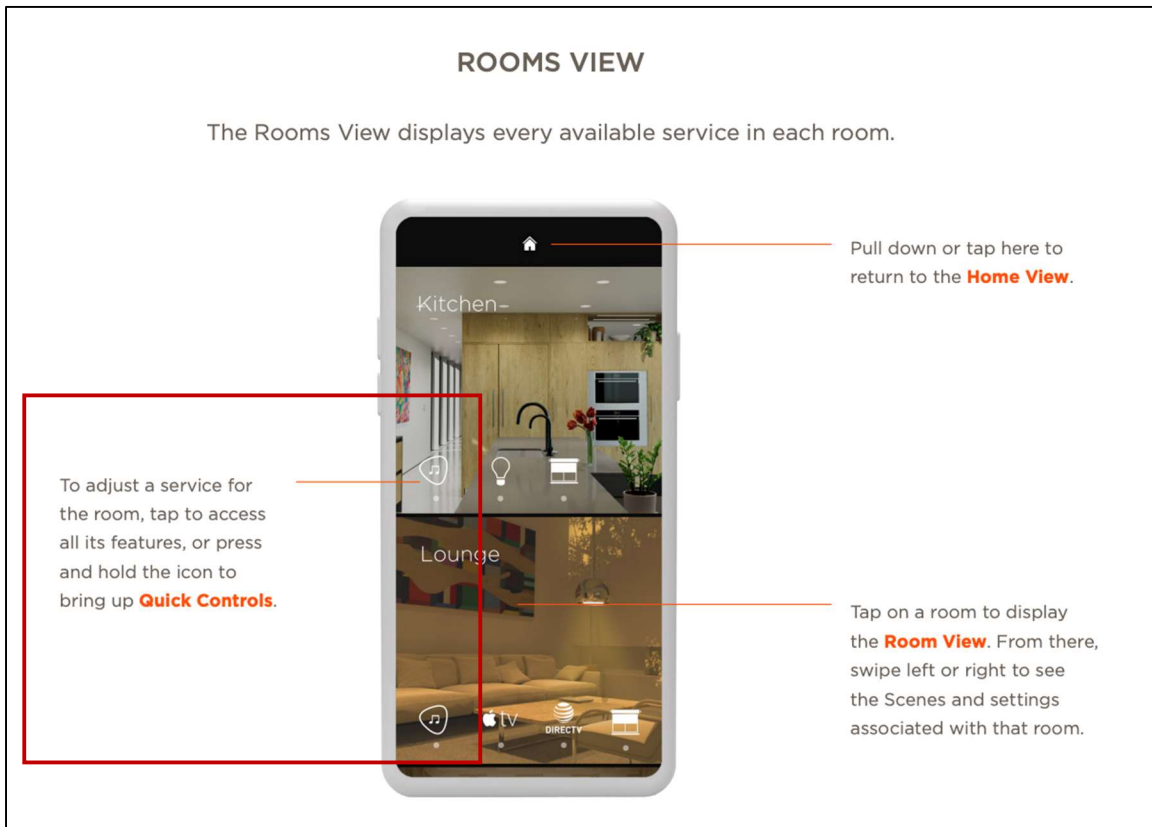

**Figure 21**

Source: Savant Pro App, SAVANT, <https://sav-marketing-sales.s3.amazonaws.com/public/Savant%20Pro%20App%202021.pdf>, at p. 4.

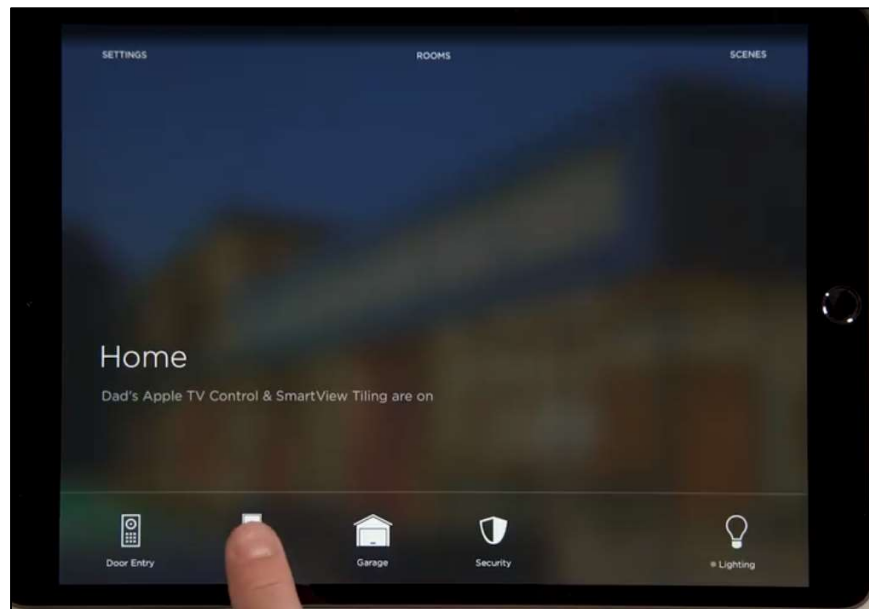

**Figure 22**

Source: Savant Smart Home Tutorial, CENTRAL COAST AV, <https://www.centralcoastav.com/savant-smart-home-demos-tutorials/savant-door-locks>.

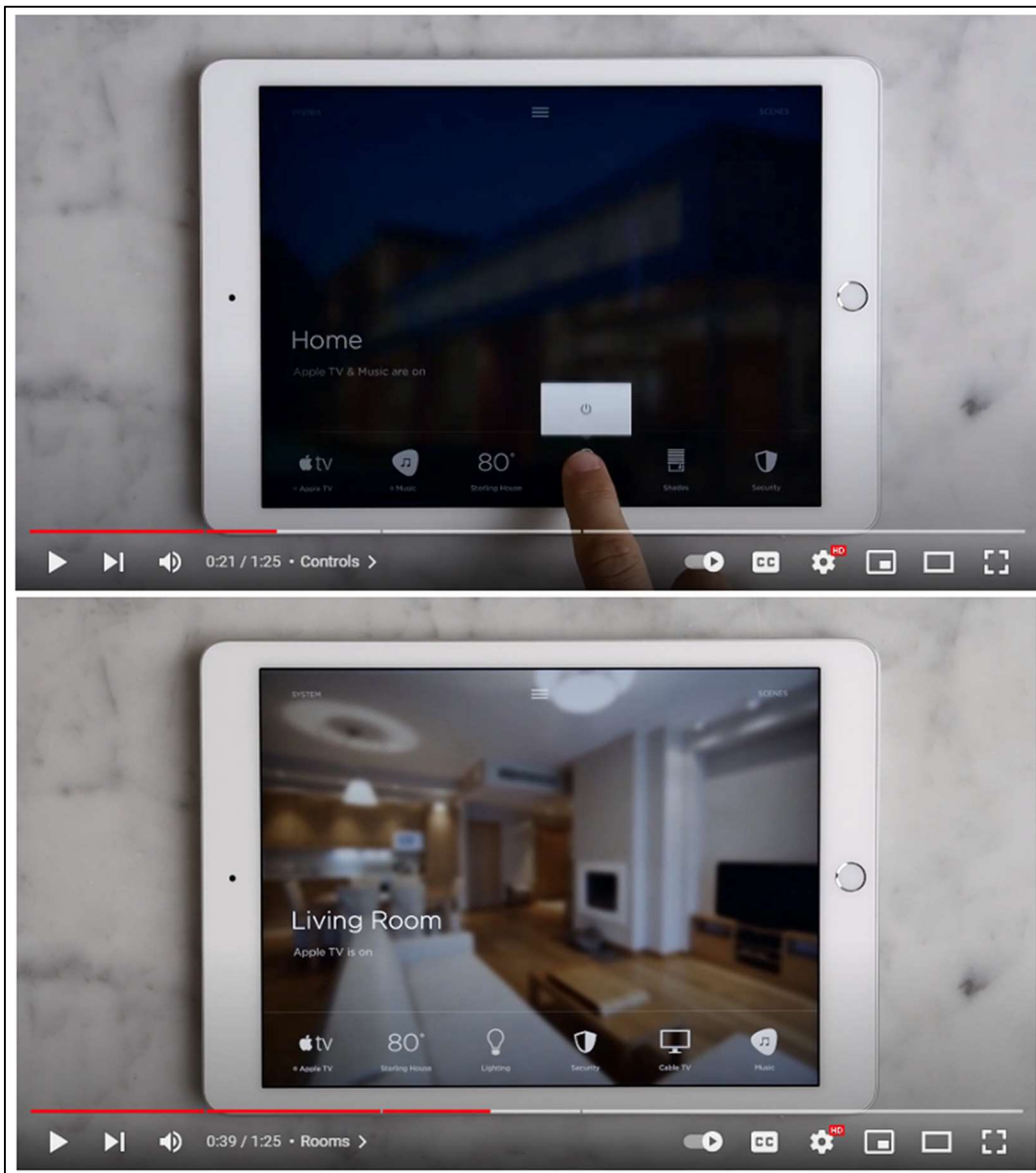
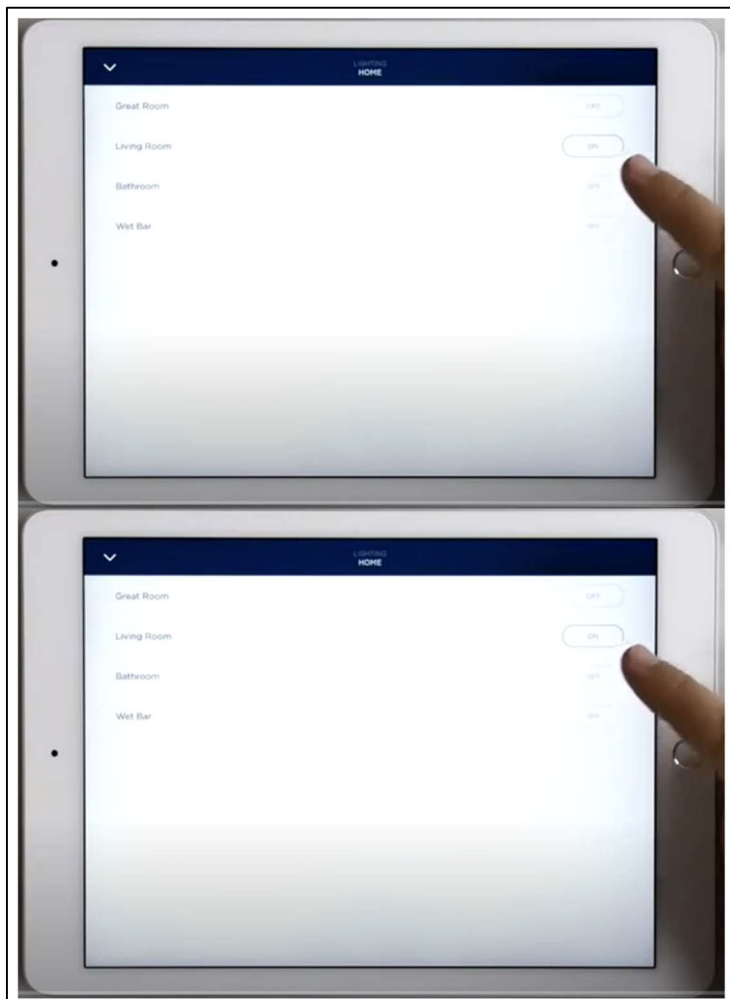

**Figure 23**

Source: YOUTUBE, <https://www.youtube.com/watch?v=dtzE9kF0zJA>.

62. In addition, as one example, the Accused Products perform the step of storing profiles for each of the user's communications devices; retrieving a profile associated with the selected communications device; interpreting the data according to a rule-based engine to categorize the data as at least one of (1) data associated with an access agent, (2) data associated with a configuration agent, (3) data associated with a security agent, and (4) data associated with a

management agent; processing the data according to an edge side assembler; and communicating the data and the profile to the selected communications device. *See, e.g., Figure 23* (above); **Figures 24-25** (below).



**Figure 24**

Source: Savant Smart Home Tutorial, CENTRAL COAST AV,  
<https://www.centralcoastav.com/savant-smart-home-demos-tutorials/savant-door-locks>.

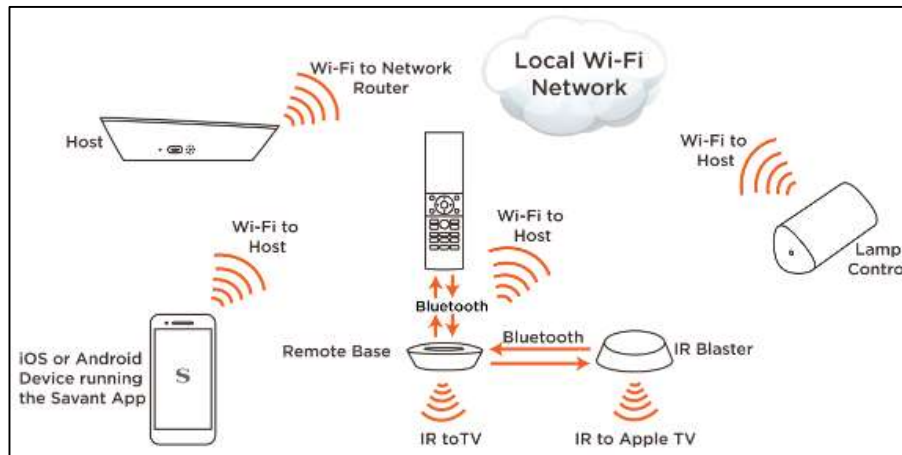

**Figure 25**

Source: SAVANT, [https://support.savant.com/help/articles/en\\_US/Support\\_Article/Network-Troubleshooting-Guide](https://support.savant.com/help/articles/en_US/Support_Article/Network-Troubleshooting-Guide) (“network diagram showing the Savant 1.x entertainment package”).

63. Since at least the time of receiving the original complaint in this action, Defendant has also indirectly infringed and continues to indirectly infringe one or more claims of the '464 patent by inducing others to directly infringe said claims. Defendant has induced end-users, including, but not limited to, Defendant's employees, partners, or contractors, to directly infringe, either literally or under the doctrine of equivalents, the '464 patent by providing or requiring use of the Accused Products. Defendant has taken active steps, directly or through contractual relationships with others, with the specific intent to cause them to use the Accused Products in a manner that infringes one or more claims of the '464 patent, including, for example, claim 1. Such steps by Defendant included, among other things, advising or directing personnel, contractors, or end-users to use the Accused Products in an infringing manner; advertising and promoting the use of the Accused Products in an infringing manner; or distributing instructions that guide users to use the Accused Products in an infringing manner. Defendant is performing these steps, which constitute induced infringement with the knowledge of the '464 patent and with the knowledge that the induced acts constitute infringement. Defendant is aware that the normal and customary use of the Accused Products by others would infringe the '464 patent. Defendant's inducement is



ongoing. *See, e.g.,* Savant Pro App, SAVANT, <https://sav-marketing-sales.s3.amazonaws.com/public/Savant%20Pro%20App%202021.pdf>; Savant Pro App Lighting Service User Guide, SAVANT, <https://sav-documentation.s3.amazonaws.com/Product%20User%20Guides/009-1696-01%20Savant%20Pro%20App%20Lighting%20Service%20User%20Guide.pdf>; Savant Pro App, ELEVATE INTEGRATION, [https://elevatedintegration.com/wp-content/uploads/2019/06/Savant\\_Pro\\_App\\_Guide.pdf](https://elevatedintegration.com/wp-content/uploads/2019/06/Savant_Pro_App_Guide.pdf); Savant Ecosystem, THE BIG CORP.COM, <https://thebigcorp.com/wp-content/uploads/2021/08/Savant-Ecosystem.pdf>; SAVANT, [https://support.savant.com/help/articles/en\\_US/Support\\_Article/How-do-I-add-Savant-Devices;](https://support.savant.com/help/articles/en_US/Support_Article/How-do-I-add-Savant-Devices;) SAVANT, [https://support.savant.com/help/articles/en\\_US/Support\\_Article/Network-Troubleshooting-Guide.](https://support.savant.com/help/articles/en_US/Support_Article/Network-Troubleshooting-Guide)

64. Since at least the time of receiving the original complaint in this action, Defendant has also indirectly infringed and continues to indirectly infringe by contributing to the infringement of the '464 patent. Defendant has contributed to the direct infringement of the '464 patent by its personnel, contractors, and customers. The Accused Products have special features that are specially designed to be used in an infringing way and that have no substantial uses other than ones that infringe one or more claims of the '464 patent, including, for example, claim 1. The special features constitute a material part of the invention of one or more of the claims of the '464 patent and are not staple articles of commerce suitable for substantial non-infringing use. Defendant's contributory infringement is ongoing. *See, e.g.,* Savant Pro App, SAVANT, <https://sav-marketing-sales.s3.amazonaws.com/public/Savant%20Pro%20App%202021.pdf>; Savant Pro App Lighting Service User Guide, SAVANT, [Page |30](https://sav-documentation.s3.amazonaws.com/Product%20User%20Guides/009-1696-</a></p>
</div>
<div data-bbox=)

[01%20Savant%20Pro%20App%20Lighting%20Service%20User%20Guide.pdf](#); Savant Pro App, ELEVATE INTEGRATION, [https://elevatedintegration.com/wp-content/uploads/2019/06/Savant\\_Pro\\_App\\_Guide.pdf](https://elevatedintegration.com/wp-content/uploads/2019/06/Savant_Pro_App_Guide.pdf); Savant Ecosystem, THE BIG CORP.COM, <https://thebigcorp.com/wp-content/uploads/2021/08/Savant-Ecosystem.pdf>; SAVANT, [https://support.savant.com/help/articles/en\\_US/Support\\_Article/How-do-I-add-Savant-Devices](https://support.savant.com/help/articles/en_US/Support_Article/How-do-I-add-Savant-Devices); SAVANT, [https://support.savant.com/help/articles/en\\_US/Support\\_Article/Network-Troubleshooting-Guide](https://support.savant.com/help/articles/en_US/Support_Article/Network-Troubleshooting-Guide).

65. Defendant had knowledge of the '464 patent at least as of the date when they were notified of the filing of the original complaint in this action.

66. Furthermore, on information and belief, Defendant has a policy or practice of not reviewing the patents of others, including instructing its employees to not review the patents of others, and thus have been willfully blind of IoT Innovations' patent rights.

67. Defendant's actions are at least objectively reckless as to the risk of infringing a valid patent and this objective risk was either known or should have been known by Defendant.

68. IoT Innovations or its predecessors-in-interest have satisfied all statutory obligations required to collect pre-filing damages for the full period allowed by law for infringement of one or more claims of the '464 patent.

69. IoT Innovations has been damaged as a result of the infringing conduct by Defendant alleged above. Thus, Defendant is liable to IoT Innovations in an amount that compensates it for such infringements, which by law cannot be less than a reasonable royalty, together with interest and costs as fixed by this Court under 35 U.S.C. § 284.

70. IoT Innovations has suffered irreparable harm, through its loss of market share and goodwill, for which there is no adequate remedy at law. IoT Innovations has and will continue to

suffer this harm by virtue of Defendant's infringement of the '464 patent. Defendant's actions have interfered with and will interfere with IoT Innovations' ability to license technology. The balance of hardships favors IoT Innovations' ability to commercialize its own ideas and technology. The public interest in allowing IoT Innovations to enforce its right to exclude outweighs other public interests, which supports injunctive relief in this case.

**COUNT IV: INFRINGEMENT OF U.S. PATENT NO. 7,974,260**

71. Plaintiff repeats and re-alleges the allegations in the Paragraphs above as though fully set forth in their entirety.

72. The USPTO duly issued U.S. Patent No. 7,974,260 (hereinafter, the "'260 patent") on July 5, 2011, after full and fair examination of Application No. 10/489,269, which was filed on September 10, 2001. *See* '260 patent at p. 1. A Certificate of Correction was issued on November 29, 2011. *See id.* at p. 17.

73. IoT Innovations owns all substantial rights, interest, and title in and to the '260 patent, including the sole and exclusive right to prosecute this action and enforce the '260 patent against infringers and to collect damages for all relevant times.

74. The claims of the '260 patent are not directed to an abstract idea and are not limited to well-understood, routine, or conventional activity. Rather, the claimed inventions include inventive components that improve upon the function and operation of timing controls among devices in a wireless network setting.

75. The written description of the '260 patent describes in technical detail each limitation of the claims, allowing a skilled artisan to understand the scope of the claims and how the non-conventional and non-generic combination of claim limitations is patently distinct from and

improved upon what may have been considered conventional or generic in the art at the time of the invention.

76. Defendant has directly infringed one or more claims of the '260 patent by using, providing, supplying, or distributing the Accused Products.

77. Defendant has directly infringed and continues to infringe, either literally or under the doctrine of equivalents, at least claim 5 of the '260 patent.

78. For example, Defendant, through the use and provision of the Accused Products, performs a method of transmitting timing control information from a first device to a second device in a communication network, the method comprising: defining a data sequence at a first device, the data sequence including a header portion and a payload portion, wherein the header portion includes an address code of a second device and the payload portion includes timing control information for communicating packets between devices in a communication network wherein the timing control information defines when the second device communicates, wherein the address code is a first active member address of the second device, and wherein the first active member address and a second active member address are assigned to the second device; and transmitting the defined data sequence in a data communication packet from the first device to the second device in a time defined contact slot. *See, e.g., Figure 26* (below); *see also* Savant Pro Remote User Guide, SAVANT, <http://sav-documentation.s3.amazonaws.com/Product%20User%20Guides/009-1410-04%20Pro%20Remote%20User%20Guide.pdf>; Savant Pro Remote User Guide, SAVANT, <https://sav-documentation.s3.amazonaws.com/Product%20User%20Guides/009-1410-06%20Savant%20Pro%20Remote%20User%20Guide.pdf>; and Declaration Letter for BT WLAN, FCCID.IO, <https://fcc.report/FCC-ID/ASU-SUR2000/3575926.pdf>.

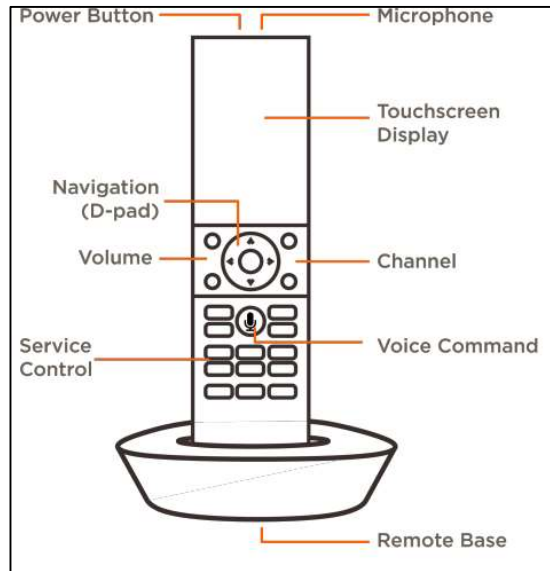

**Figure 26**

Source: Savant Pro Remote User Guide, SAVANT, <http://sav-documentation.s3.amazonaws.com/Product%20User%20Guides/009-1410-04%20Pro%20Remote%20User%20Guide.pdf>, at p. 1; *see also id.* at p. 9.

79. IoT Innovations or its predecessors-in-interest have satisfied all statutory obligations required to collect pre-filing damages for the full period allowed by law for infringement of one or more claims of the '260 patent.

80. IoT Innovations has been damaged as a result of the infringing conduct by Defendant alleged above. Thus, Defendant is liable to IoT Innovations in an amount that compensates it for such infringements, which by law cannot be less than a reasonable royalty, together with interest and costs as fixed by this Court under 35 U.S.C. § 284.

#### **COUNT V: INFRINGEMENT OF U.S. PATENT NO. 7,974,266**

81. Plaintiff repeats and re-alleges the allegations in the Paragraphs above as though fully set forth in their entirety.

82. The USPTO duly issued U.S. Patent No. 7,974,266 (hereinafter, the "'266 patent") on July 5, 2011, after full and fair examination of Application No. 11/778,822, which was filed on

July 17, 2007. '266 patent at p. 1. A Certificate of Correction was issued on November 22, 2011. *See id.* at p. 11.

83. IoT Innovations owns all substantial rights, interest, and title in and to the '266 patent, including the sole and exclusive right to prosecute this action and enforce the '266 patent against infringers and to collect damages for all relevant times.

84. The claims of the '266 patent are not directed to an abstract idea and are not limited to well-understood, routine, or conventional activity. Rather, the claimed inventions include inventive components that improve upon the function and operation of data transmission in a in a packet switch network.

85. The written description of the '266 patent describes in technical detail each limitation of the claims, allowing a skilled artisan to understand the scope of the claims and how the non-conventional and non-generic combination of claim limitations is patently distinct from and improved upon what may have been considered conventional or generic in the art at the time of the invention.

86. Defendant has directly infringed one or more claims of the '266 patent by using, providing, supplying, or distributing the Accused Products.

87. Defendant has directly infringed and continues to infringe, either literally or under the doctrine of equivalents, at least claim 1 of the '266 patent.

88. For example, Defendant, through the use and provision of the Accused Products, performs a method of classifying data comprising: receiving Internet Protocol (IP) data at a first node; classifying the IP data received at the first node based on a last destination address entry of a plurality of destination address entries in a header of the IP data; and forwarding the IP data from the first node to a second node, wherein the IP data is classified at the second node based on the

last destination address entry of the plurality of destination address entries in the header of the IP data. See, e.g., **Figure 27** (below); Savant IP Video Network, SAVANT, <https://sav-documentation.s3.amazonaws.com/Product%20Deployment%20Guides/009-1552-04%20Savant%20IP%20Video%20Network%20Configuration%20Guide.pdf>; Support, APPLE, <https://support.apple.com/en-in/guide/mac-help/mchlp2499/mac>; and Savant Quick Reference Guide, SAVANT, <https://sav-documentation.s3.amazonaws.com/Product%20QRGs/009-2065-01%20Savant%20Touch%208%20Inch%20Control%20Screen%20V2%20QRG.pdf>.

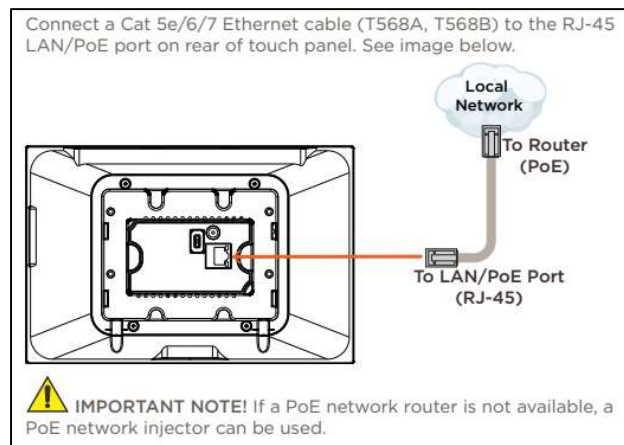

**Figure 27**

Source: Savant Quick Reference Guide, SAVANT, <https://sav-documentation.s3.amazonaws.com/Product%20QRGs/009-2065-01%20Savant%20Touch%208%20Inch%20Control%20Screen%20V2%20QRG.pdf>, at p. 2.

89. IoT Innovations or its predecessors-in-interest have satisfied all statutory obligations required to collect pre-filing damages for the full period allowed by law for infringement of one or more claims of the '266 patent.

90. IoT Innovations has been damaged as a result of the infringing conduct by Defendant alleged above. Thus, Defendant is liable to IoT Innovations in an amount that compensates it for such infringements, which by law cannot be less than a reasonable royalty, together with interest and costs as fixed by this Court under 35 U.S.C. § 284.



**JURY DEMAND**

91. IoT Innovations hereby requests a trial by jury on all issues so triable by right.

**PRAYER FOR RELIEF**

92. IoT Innovations requests that the Court find in its favor and against Defendant, and that the Court grant IoT Innovations the following relief:

- a. Judgment that one or more claims of each of the Asserted Patents has been infringed, either literally or under the doctrine of equivalents, by Defendant or others acting in concert therewith;
- b. A permanent injunction enjoining Defendant and its officers, directors, agents, servants, affiliates, employees, divisions, branches, subsidiaries, parents, and all others acting in concert therewith from infringement of the '224 patent, the '830 patent, and the '464 patent; or, in the alternative, an award of a reasonable ongoing royalty for future infringement of said patents by such entities;
- c. Judgment that Defendant accounts for and pays to IoT Innovations all damages to and costs incurred by IoT Innovations because of Defendant's infringing activities and other conduct complained of herein;
- d. Judgment that Defendant's infringements be found willful as to the '224 patent, the '830 patent, and the '464 patent, and that the Court award treble damages for the period of such willful infringement pursuant to 35 U.S.C. § 284;
- e. Pre-judgment and post-judgment interest on the damages caused by Defendant's infringing activities and other conduct complained of herein;
- f. That this Court declare this an exceptional case and award IoT Innovations its reasonable attorneys' fees and costs in accordance with 35 U.S.C. § 285; and

- g. All other and further relief as the Court may deem just and proper under the circumstances.

Dated: January 4, 2024

Respectfully submitted,

/s/ David S. Godkin

David S. Godkin (BBO #196530)

James E. Kruzer (BBO #670827)

**BIRNBAUM & GODKIN, LLP**

1 Marina Park Drive, Suite 1410

Boston, Massachusetts 02210

Telephone: (617) 307-6100

Email: godkin@birnbaumgodkin.com

Email: kruzer@birnbaumgodkin.com

Of Counsel

James F. McDonough, III (GA 117088) \*

Jonathan R. Miller (GA507179) \*

Travis E. Lynch (GA 162373) \*

**Rozier Hardt McDonough, PLLC**

659 Auburn Avenue NE, Unit 254

Atlanta, Georgia 30312

Telephone: (404) 564-1866, -1863, -1862

Email: jim@rhmtrial.com

Email: miller@rhmtrial.com

Email: lynch@rhmtrial.com

Jonathan L. Hardt (TX 24039906) \*

**Rozier Hardt McDonough, PLLC**

712 W. 14th Street, Suite C

Austin, Texas 78701

Telephone: (737) 295-0876

Email: hardt@rhmtrial.com

C. Matthew Rozier (CO 46854) \*

**Rozier Hardt McDonough, PLLC**

1500 K Street, 2<sup>nd</sup> Floor

Washington, DC 20005

Telephone: (404) 779-5305

Email: matt@rhmtrial.com

*Attorneys for Plaintiff IOT INNOVATIONS LLC*

\*Admission *pro hac vice* anticipated

### **List Of Supportive Links**

1. U.S. Patent No. 7,165,224, USPTO.GOV, <https://patentcenter.uspto.gov/applications/10262969>, <https://image-ppubs.uspto.gov/dirsearch-public/print/downloadPdf/7165224>.
2. U.S. Patent No. 7,280,830, USPTO.GOV, <https://patentcenter.uspto.gov/applications/10859735>, <https://image-ppubs.uspto.gov/dirsearch-public/print/downloadPdf/7280830>.
3. U.S. Patent No. 7,379,464, USPTO.GOV, <https://patentcenter.uspto.gov/applications/10306504>, <https://image-ppubs.uspto.gov/dirsearch-public/print/downloadPdf/7379464>.
4. U.S. Patent No. 7,974,260, USPTO.GOV, <https://patentcenter.uspto.gov/applications/10489269>, <https://image-ppubs.uspto.gov/dirsearch-public/print/downloadPdf/7974260>.
5. U.S. Patent No. 7,974,266, USPTO.GOV, <https://patentcenter.uspto.gov/applications/11778822>, <https://image-ppubs.uspto.gov/dirsearch-public/print/downloadPdf/7974266>.
6. SAVANT, <https://sav-documentation.s3.amazonaws.com/Product%20Reference%20Guides/009-1712-00%20Savant%20Studio%20User%20Guide.pdf>.
7. SAVANT, <https://sav-documentation.s3.amazonaws.com/Product%20User%20Guides/009-1696-01%20Savant%20Pro%20App%20Lighting%20Service%20User%20Guide.pdf>.
8. Savant Pro App, SAVANT, <https://sav-marketing-sales.s3.amazonaws.com/public/Savant%20Pro%20App%202021.pdf>.
9. Declaration Letter for BT WLAN, FCCID.IO, <https://fcc.report/FCC-ID/ASU-SUR2000/3575926.pdf>.
10. Savant Door Locks, CENTRAL COAST AV, <https://www.centralcoastav.com/savant-smart-home-demos-tutorials/savant-door-locks>.
11. Savant Ecosystem, THE BIG CORP.COM, <https://thebigcorp.com/wp-content/uploads/2021/08/Savant-Ecosystem.pdf>.
12. Savant Entry Services, SAVANT, [https://sav-marketing-sales.s3.amazonaws.com/public/Savant-Entry-Services-6x9\\_DIGITAL.pdf](https://sav-marketing-sales.s3.amazonaws.com/public/Savant-Entry-Services-6x9_DIGITAL.pdf).
13. Savant IP Video Network, SAVANT, <https://sav-documentation.s3.amazonaws.com/Product%20Deployment%20Guides/009-1552-04%20Savant%20IP%20Video%20Network%20Configuration%20Guide.pdf>.

14. Savant Pro App, ELEVATE INTEGRATION, [https://elevatedintegration.com/wp-content/uploads/2019/06/Savant\\_Pro\\_App\\_Guide.pdf](https://elevatedintegration.com/wp-content/uploads/2019/06/Savant_Pro_App_Guide.pdf).
15. Savant Pro Remote User Guide, SAVANT, <http://sav-documentation.s3.amazonaws.com/Product%20User%20Guides/009-1410-04%20Pro%20Remote%20User%20Guide.pdf>.
16. Savant Pro Remote User Guide, SAVANT, <https://sav-documentation.s3.amazonaws.com/Product%20User%20Guides/009-1410-06%20Savant%20Pro%20Remote%20User%20Guide.pdf>.
17. Savant Product User Guide, SAVANT, <https://sav-documentation.s3.amazonaws.com/Product%20User%20Guides/009-1838-05%20Savant%20Pro%20App%20User%20Guide%20%5BVersion%209.4%20and%20Higher%5D.pdf>.
18. Savant Quick Reference Guide, SAVANT, <https://sav-documentation.s3.amazonaws.com/Product%20QRGs/009-2065-01%20Savant%20Touch%208%20Inch%20Control%20Screen%20V2%20QRG.pdf>.
19. SAVANT, <https://cdn.savant.com/docs/brochures/Savant+Entry+Services+Brochure+2021-01.pdf>.
20. SAVANT, <https://sav-documentation.s3.amazonaws.com/Product%20Programming%20Guides/009-1810-00%20Savant%20Lighting%20and%20Keypad%20Programming%20Guide.pdf>.
21. SAVANT, [https://store.savant.com/DefaultStore/ccrz\\_\\_ProductDetails?viewState=DetailView&sku=DMX-DRIVER3-00#](https://store.savant.com/DefaultStore/ccrz__ProductDetails?viewState=DetailView&sku=DMX-DRIVER3-00#).
22. SAVANT, [https://support.savant.com/help/articles/en\\_US/Support\\_Article/How-do-I-add-Savant-Devices](https://support.savant.com/help/articles/en_US/Support_Article/How-do-I-add-Savant-Devices).
23. SAVANT, [https://support.savant.com/help/articles/en\\_US/Support\\_Article/Network-Troubleshooting-Guide](https://support.savant.com/help/articles/en_US/Support_Article/Network-Troubleshooting-Guide).
24. SAVANT, [https://support.savant.com/help/articles/en\\_US/Support\\_Article/What-is-a-Savant-Host](https://support.savant.com/help/articles/en_US/Support_Article/What-is-a-Savant-Host).
25. SAVANT, <https://www.savant.com/>.
26. SAVANT, <https://www.savant.com/case-studies/farmhouse>.
27. SAVANT, <https://www.savant.com/entry-services>.
28. SAVANT, <https://www.savant.com/eula>.

29. SAVANT, <https://www.savant.com/interfaces>.
30. Support, APPLE.COM, <https://support.apple.com/en-in/guide/mac-help/mchlp2499/mac>.
31. YOUTUBE, <https://www.youtube.com/watch?v=-B9hEkfjoG8>.
32. YOUTUBE, <https://www.youtube.com/watch?v=dtzE9kF0zJA>.
33. *Savant Systems Inc.*, APP STORE, <https://apps.apple.com/us/app/savant/id1095325838>;
34. *Savant Systems Inc.*, GOOGLE PLAY STORE, <https://play.google.com/store/apps/details?id=com.savantsystems.controlapp.pro&hl>.