

1 Tony Caliendo, #023138
2 tony@orangewoodlaw.com



3
4 **ORANGEWOOD**
5 LAW GROUP, PLC
6 1930 EAST BROWN ROAD SUITE 103
7 MESA, ARIZONA 85203
8 TELEPHONE: (480) 500-9741
9 *Attorneys for Plaintiff*

10
11 **UNITED STATES DISTRICT COURT**
12 **DISTRICT OF ARIZONA**

13 LunaMarie LLC, an Arizona limited liability
14 company,

15 Plaintiff,

16 v.

17 Remy and Roo, LLC, a Utah limited liability
18 company,

19 Defendant.

No. _____

**COMPLAINT FOR DECLARATORY
JUDGMENT OF (1) INVALIDITY;
AND (2) NONINFRINGEMENT**

DEMAND FOR JURY TRIAL

20 For its Complaint, Plaintiff (“**LunaMarie**”) alleges as follows:

21 **NATURE OF ACTION**

22 1. This is an action for a declaratory judgment arising under the patent laws of
23 Title 35 of the United States Code. Plaintiff seeks a declaratory judgment that (1) United
24 States Design Patent D1,000,009 (the “**’009 Patent**”) is invalid; and (2) LunaMarie does not
25 infringe the ’009 Patent.

26 **PARTIES**

- 27 2. LunaMarie is an Arizona limited liability company.
- 28 3. Defendant Remy and Roo, LLC (“**Remy and Roo**”) is a Utah limited liability
29 company.
- 30 4. Upon information and belief, Remy and Roo is the owner of the ’009 Patent.

ORANGEWOOD LAW GROUP, PLC
1930 EAST BROWN ROAD, SUITE 103
MESA, AZ 85203

JURISDICTIONAL STATEMENT

1
2 5. This action arises under the Declaratory Judgment Act, 28 U.S.C. § 2201 et
3 seq., and under the patent laws of Title 35 of the United States Code.

4 6. This Court has subject matter jurisdiction over this action under 28 U.S.C. §§
5 1331, 1338(a), and 2201(a).

6 7. This Court has personal jurisdiction over Remy and Roo.

7 8. Remy and Roo caused a letter dated November 28, 2023 (the “**Letter**”) to be
8 sent to LunaMarie in Tempe, Arizona.

9 9. A copy of the Letter is attached as **Exhibit 1**.

10 10. The Letter accuses LunaMarie of “offering for sale” bandanas “that appear be
11 covered by [the ’009 Patent].”

12 11. The Letter attached a copy of the ’009 Patent.

13 12. The Letter demands that LunaMarie immediately agree to cease the
14 unauthorized copying, reproduction, and distribution of Remy and Roo’s “patented designs”
15 and pay “reasonable damages” for the “infringements to date.” The Letter states: “If Luna
16 Marie does not so agree, Remy+Roo will seek both a preliminary and permanent injunction
17 against Luna Marie, and will seek awards of damages and attorneys’ fees. Remy+Roo
18 therefore demands that Luna Marie execute the Agreement set forth below within 20 days of
19 the date of this letter, in order to resolve this matter without litigation.”

20 13. Remy and Roo purposefully directed enforcement activities into Arizona with
21 respect to the ’009 Patent.

22 14. Remy and Roo has taken steps, in this District, to assert the ’009 Patent against
23 LunaMarie.

24 15. Venue is proper in this District under 28 U.S.C. § 1391(b)-(c) because a
25 substantial part of the events giving rise to LunaMarie’s claim occurred in this District, and
26 because Remy and Roo is subject to personal jurisdiction here.

1 to the specification stating whether the broken lines form part of the claim or not and another
 2 statement stating whether the broken lines outline of a rectangle form part of the claim or
 3 not.”

4 27. In the rejection, the examiner stated in part: “The claim is rejected under 35
 5 U.S.C. § 103 as being unpatentable over Remy+Roo Dog Bandanas, published: 05/04/2019
 6 (‘Remy’, NPL Reference V), in view of KeaBabies Organic Baby Bandana Drool Bibs,
 7 published: 11/09/2018 (‘KeaBabies’, NPL Reference W).”

8 28. The “Remy” reference was a reference to a Remy and Roo listing on
 9 Amazon.com.

10 29. The examiner included the following in the rejection:

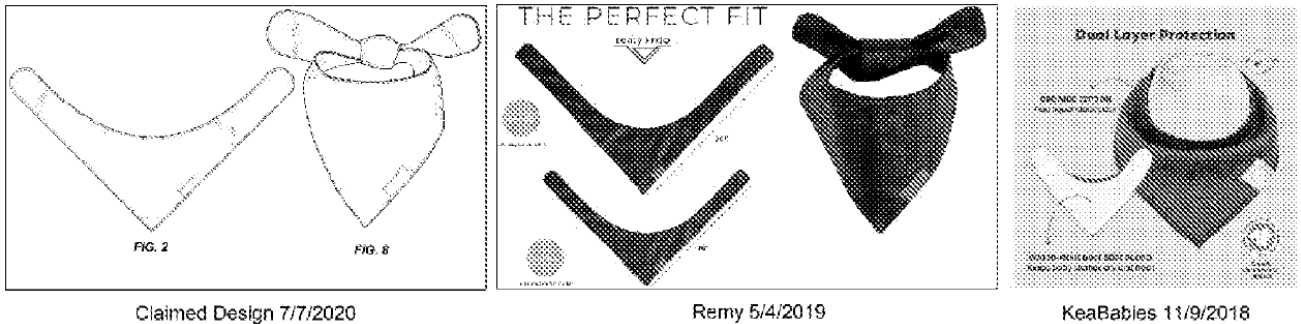

17 30. The examiner stated: “It would have been obvious to one of ordinary skill in the
 18 art at the time the invention was made to modify the bandana of Remy by making it with
 19 shorter straps with ends that are round as taught by KeaBabies.”

20 31. On or about October 13, 2022, Remy and Roo submitted an “Amendment and
 21 Response to Non-Final Office Action” (the “**Amendment**”) to the USPTO.

22 32. The relevant portions of the Amendment are attached as **Exhibit 4**.

23 33. The Amendment amended the descriptions of FIG. 1 and FIG. 8 as instructed
 24 by the examiner.

25 34. The Amendment added a “broken lines statement to the specification” as
 26 instructed by the examiner.

ORANGEWOOD LAW GROUP, PLC
 1930 EAST BROWN ROAD, SUITE 103
 MESA, AZ 85203

1 35. The Amendment’s “broken lines statement” stated: “The broken lines in the
 2 drawings depict stitching that forms part of the claimed design.”

3 36. The Amendment also included remarks stating that the Remy reference (the
 4 Amazon.com listing) did not qualify as prior art, because the examiner “made no showing
 5 that the photos viewed on the [Amazon.com] website in July 2022 were actually present on
 6 the dynamic website on the alleged assigned publication date of May 2, 2019 [sic, May 4,
 7 2019].”

8 37. The Amendment concluded by requesting that the rejection be withdrawn.

9 38. On or about November 8, 2022, the examiner issued a non-final rejection.

10 39. The relevant portions of that non-final rejection are attached as **Exhibit 5**.

11 40. The rejection stated in part: “The objections to the Specification have been
 12 overcome and are withdrawn. The rejection under 35 U.S.C. § 103 has been carefully
 13 considered in view of Applicant’s response and amendments; although it is the Examiner’s
 14 position that the rejection has not been overcome by Applicant’s response, the rejection is
 15 withdrawn. Upon further search for prior art, new non-final rejections under 35 U.S.C. § 103
 16 are detailed further down in this office action. . . . The claim is rejected under 35 U.S.C. § 103
 17 as being unpatentable over U.S. patent number D515250 to Story on 02/14/2006; in view of
 18 U.S. patent number D631208 to Gazaway on 01/18/2011.”

19 41. The rejection included the following:



Claimed Design 7/7/2020

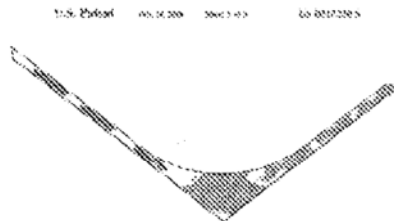

Story 02/14/2006



Gazaway 01/18/2011

1 42. The rejection stated: “It would have been obvious to one of ordinary skill in the
2 art at the time the invention was made to modify the bandana of Story by making it with
3 wider straps of equal length that have round ends as taught by Gazaway.”

4 43. The rejection stated: “A de minimis difference between the claimed design and
5 the prior art is that the claimed design has stitching all along the edges and a small
6 rectangular stitched feature on the right front side near the point. This minor difference does
7 not create a patentably distinct design.”

8 44. On or about February 6, 2023, Remy and Roo submitted a “Response to Non-
9 Final Office Action” (the “**Response**”) to the USPTO.

10 45. The relevant portions of the Response are attached as **Exhibit 6**.

11 46. The Response advanced three primary arguments.

12 47. The Response stated in part: “[T]he assertion in the Office Action that the
13 stitching is de minimis or inconsequential is entirely unsupported. Rather, looking at the
14 figures themselves, it is clear that the stitching is at least one of the more distinctive and
15 prominent portions of the design of the bandana.”

16 48. The Response further stated in part: “Neither Story nor Gazaway discloses the
17 asymmetric shape of the bandana. As best shown in FIG. 2, the claimed design of the
18 bandana exhibits an overall side-to-side asymmetric appearance with the curvature of the
19 upper edge being offset relative to the lower point of the bottom edge of the bandana. The
20 references of record [Story and Gazaway] entirely fail to disclose such a distinctive shape of
21 the bandana design.”

22 49. The Response further stated in part: “Neither Story nor Gazaway discloses the
23 overall shape of the bandana. . . . [T]he offset for asymmetrical upper curvature of the instant
24 design blends into two rounded ends that are angled upward. Both Story and Gazaway further
25 fail to disclose such a design Further, the arms of Story’s horse bandana are clearly two
26 or more times longer and exhibit an entirely different appearance than that of the instant

1 claimed design of the Bandana that includes relatively shorter, thicker arms that angle upward
2 and terminate in the rounded ends.”

3 50. On or about March 28, 2023, the USPTO issued a final rejection.

4 51. The relevant portions of that final rejection are attached as **Exhibit 7**.

5 52. The rejection stated in part: “The claim is AGAIN AND FINALLY
6 REJECTED under 35 U.S.C. § 103 as being unpatentable over U.S. patent number D515250
7 to Story on 02/14/2006; in view of U.S. patent number D631208 to Gazaway on 01/18/2011.
8 . . . The bandana of Story has design characteristics that are basically the same as the claimed
9 design: It has an overall triangular shape with the left and right sides that are straight come to
10 a 90 degree point at the bottom center of the garment. The top edge curves downward and the
11 left and right sides narrow toward the top to form straps. The claimed design differs from
12 Story in that the straps on Story are narrower in proportion to the rest of the body, not of the
13 same length, and ends of the straps have an angled squared off edge; while the claimed design
14 has straps that are wider in proportion to the rest of the body, they are of equal length, and are
15 round at the ends. Gazaway shows a bandana with straps that are wider in proportion to the
16 rest of the body, of equal length, and are round at the ends. A de minimis difference between
17 the claimed design and the prior art is that the claimed design has stitching all along the edges
18 and a small rectangular stitched feature on the right front side near the point. This minor
19 difference does not create a patentably distinct design. . . . It would have been obvious to one
20 of ordinary skill in the art at the time the invention was made to modify the bandana of Story
21 by making it with wider straps of equal length that have round ends as taught by Gazaway.”

22 53. The rejection further stated in part: “The claim is AGAIN AND FINALLY
23 REJECTED under 35 U.S.C. § 103 as being unpatentable over U.S. patent number D309212
24 to Maletsky, et al on 07/17/1990; in view of U.S. patent number D631208 to Gazaway on
25 01/18/2011.”

26 54. The rejection included the following:

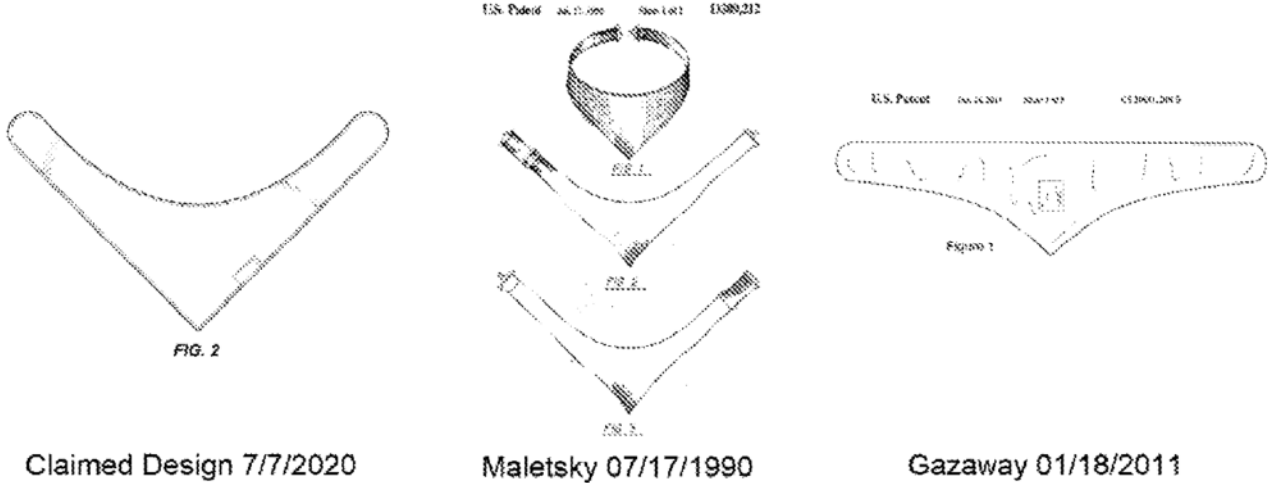

55. The rejection stated: “The necktie of Maletsky has design characteristics that are basically the same as the claimed design: It has an overall triangular shape with the left and right sides that come to a point at the bottom center of the garment. The top edge curves downward and the left and right sides narrow toward the top to form straps. The claimed design differs from Maletsky in that the straps on Maletsky have a buckle on the left strap and a clasp on the right strap and the straps are more squared off at the ends while the claimed design has straps that have no fasteners and that straps are round at the ends. Gazaway shows a bandana without buckles or clasps with straps that are round at the ends. A de minimis difference between the claimed design and the prior art is that the claimed design has stitching all along the edges and a small rectangular stitched feature on the right front side near the point. This minor difference does not create a patentably distinct design. . . . It would have been obvious to one of ordinary skill in the art at the time the invention was made to modify the necktie of Maletsky by making it without fasteners and with straps that have round ends as taught by Gazaway.”

56. With respect to Remy and Roo’s assertion that “the claimed design of the bandana exhibits an overall side-to-side asymmetric appearance with the curvature of the upper edge being offset relative to the lower point of the bottom edge of the bandana,” the rejection stated: “The examiner disagrees. The drawing of FIG. 2 shows a bandana that is

1 symmetrical, if you duplicated FIG. 2 then flip the image and overlay the flipped image on
2 top of the original image, the edges line up perfectly.”

3 57. On or about June 26, 2023, Remy and Roo submitted a “Pre-Appeal Brief.”

4 58. A copy of the Pre-Appeal Brief is attached as **Exhibit 8**.

5 59. The Pre-Appeal Brief advanced three primary arguments.

6 60. The Pre-Appeal Brief stated in part: “[T]he distinctive stitching of the bandana
7 is part of the patentable design. . . . [T]he assertion in the [Final Office Action] that the
8 stitching is de minimis or inconsequential is entirely unsupported.”

9 61. The Pre-Appeal Brief further stated: “As best shown in FIG. 2, the claimed
10 design of the bandana exhibits an asymmetric appearance due to the additional stitching on
11 one side of the bandana. The references of record entirely fail to disclose such a distinctive
12 shape of the bandana design.”

13 62. The Pre-Appeal Brief further stated that neither Story nor Gazaway nor
14 Maletsky disclose a bandana having “two arms with rounded ends that are angled upward.”
15 According to the Pre-Appeal Brief, the arms of Story’s bandana “are clearly two or more
16 times longer,” and “narrower and squared-off,” while “the arms of Maletsky’s bandana are
17 clearly longer . . . and squared-off.”

18 63. On or about August 16, 2023, the USPTO issued a Notice of Allowance.

19 64. The relevant portions of the Notice of Allowance are attached as **Exhibit 9**.

20 65. The Notice of Allowance stated: “Applicant’s arguments submitted on
21 02/06/2023 in response to the Non-Final Rejection were not persuasive; specifically, that the
22 stitching and the asymmetric appearance of the bandana are what makes this design novel.
23 However, upon further consideration the Examiner finds that while the overall shape of Story
24 and Maletsky are close to the claimed design; it is the combination of the shape with the
25 rounded features that creates a design that is patentably distinct and sufficient to overcome
26 the standing rejection which is hereby withdrawn.”

1 66. The '009 Patent issued on September 26, 2023.

2 67. A copy of the '009 Patent is attached as **Exhibit 10**.

3 **Remy and Roo's Subsequent Statements Regarding the '009 Patent**

4 68. Remy and Roo has publicly stated that the '009 Patent covers the "shape" of the
5 bandanas—specifically the "two long ends" of the bandana and the "curved design."

6 69. By way of example only, Remy and Roo published an Amazon.com listing
7 stating: "Remy+Roo bandanas have a unique design with two long ends making the dog
8 bandana adjustable to the exact size of your pet's neck. The bandana has a curved design to
9 mimic your dogs natural neck-line. It is designed to fit comfortably while eliminating bulk,
10 folds and excess fabric. . . . PATENTED SHAPE: All our bandanas are protected by US-
11 D1000009-S."

12 70. A copy of that Amazon.com listing is attached as **Exhibit 11**.

13 71. Remy and Roo's website states: "Curved design to mimic your dog's natural
14 neckline keeping the bandana closer to your pet's body. . . . Fits comfortably while
15 eliminating bulk, folds, and excess fabric. Patented Shape protected by US-D1000009-S. . . .
16 Our durable polyester fabric and unique shape ensure a perfect fit for your pet."

17 72. A screenshot of Remy and Roo's website is attached as **Exhibit 12**.

18 73. According to Remy and Roo, the "two long ends" and the "curved design" of
19 the bandana are both functional aspects of the bandana.

20 74. According to Remy and Roo, the two long ends "mak[e] the dog bandana
21 adjustable to the exact size of your pet's neck."

22 75. According to Remy and Roo, the "curved design" is to "ensure a perfect fit for
23 your pet" by "mimic[king] your dog's natural neckline[,] keeping the bandana closer to your
24 pet's body," and "eliminating bulk, folds, and excess fabric."

25
26

COUNT 1

(Declaratory Judgment of Invalidity of U.S. Patent No. D1,000,009)

76. LunaMarie incorporates all allegations in this Complaint as if set forth here.

77. The '009 Patent is invalid under 35 U.S.C. § 103 for obviousness.

78. By way of example only, the '009 Patent is invalid in view of the prior art cited by the USPTO in the communications attached to this Complaint and referenced above.

79. By way of example only, the business that operates as “Charlotte’s Pet” (www.charlottespet.com) has been manufacturing and selling bandanas for pets since May 2017 at the latest.

80. Images of pet bandanas that predate the Filing Date are attached as **Exhibit 13**.

81. By way of further example only, a video posted on YouTube on May 27, 2018 (125,598 views as of Jan. 9, 2024), shows how to create a pet bandana like Remy and Roo’s claimed design. See <https://www.youtube.com/watch?v=1On3uQsCRTw&t=36s>.

82. The '009 Patent is invalid under 35 U.S.C. § 112 for lack of definiteness.

83. By way of example only, according to the specification of the '009 Patent, FIG. 2 is “a front view of the design” and FIG. 8 is “another perspective view of the design in a tied configuration.”

84. FIG. 2 and FIG. 8 are reproduced here:



FIG. 2

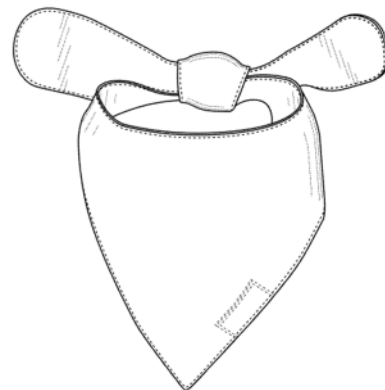

FIG. 8

1 85. The arms shown in FIG. 8 are significantly longer than the arms shown in FIG.
2 2, especially when one considers that the arms shown in FIG. 8 are tied in a knot or bow.

3 86. Because of the significant disparity in the length of the arms shown in those two
4 figures, which purport to show the same design, the '009 Patent fails to inform, with
5 reasonable certainty, those skilled in the art about the scope of the invention.

6 87. The '009 Patent is also invalid because it claims a purely functional design.

7 88. The overall appearance of the patented design is dictated by its function.

8 89. As a result of the acts described herein, there exists a substantial controversy of
9 sufficient immediacy and reality to warrant the issuance of a declaratory judgment.

10 90. A judicial declaration is necessary and appropriate so that LunaMarie may
11 ascertain its rights regarding the '009 Patent.

12 91. LunaMarie is entitled to a judicial declaration that the '009 Patent is invalid.

13 **COUNT 2**

14 **(Declaratory Judgment of Non-Infringement of U.S. Patent No. D1,000,009)**

15 92. LunaMarie incorporates all allegations in this Complaint as if set forth here.

16 93. The following is a screenshot taken from LunaMarie's website
17 (www.shoplunamarie.com/collections/bandanas) showing the bandanas that LunaMarie
18 manufactures and sells:



1 94. In its attempts to obtain the '009 Patent, Remy and Roo distinguished its design
2 from prior art on the grounds that its design had arms with rounded ends, while the prior art
3 had squared-off ends.

4 95. In finally issuing a notice of allowance, the examiner emphasized that it was
5 “the combination of the shape *with the rounded features* that creates a design that is
6 patentably distinct and sufficient to overcome the standing rejection which is hereby
7 withdrawn.” (Emphasis added.)

8 96. LunaMarie’s bandanas have arms with ends that are squared-off, not rounded.

9 97. Additionally, according to Remy and Roo’s public statements in its Amazon
10 listings and its own website, the shape of the patented design is dictated by functional
11 considerations.

12 98. The '009 Patent claims a purely functional design.

13 99. The overall appearance of the patented design is dictated by its function.

14 100. To the extent LunaMarie’s bandanas have features similar to the functional
15 aspects of the patented design, such similarities do not constitute patent infringement.

16 101. LunaMarie has not infringed and does not infringe any valid, enforceable claim
17 of the '009 Patent, directly or indirectly, literally or under the doctrine of equivalents, through
18 the manufacture, use, sale, or offer for sale of LunaMarie’s accused products.

19 102. As a result of the acts described herein, there exists a substantial controversy of
20 sufficient immediacy and reality to warrant the issuance of a declaratory judgment.

21 103. A judicial declaration is necessary and appropriate so that LunaMarie may
22 ascertain its rights regarding the '009 Patent.

23 104. LunaMarie is entitled to a judicial declaration that it has not infringed and does
24 not infringe the '009 Patent.

25
26

1 **PRAYER FOR RELIEF**

2 LunaMarie respectfully requests the following relief:

- 3 A. That the Court enter a judgment declaring that the '009 Patent is invalid;
- 4 B. That the Court enter a judgment declaring that LunaMarie has not infringed and
5 does not infringe any valid and enforceable claim of the '009 Patent;
- 6 C. That the Court declare that this case is exceptional under 35 U.S.C. § 285 and
7 award LunaMarie its attorney fees, costs, and expenses incurred in this action;
- 8 D. That the Court award LunaMarie any and all other relief to which LunaMarie
9 may show itself to be entitled; and
- 10 E. That the Court award LunaMarie any other relief that the Court deems just,
11 equitable, and proper.

12 **JURY DEMAND**

13 LunaMarie demands a jury trial on all issues and claims so triable.

14
15
16 January 9, 2024

ORANGEWOOD LAW GROUP, PLC
/s/ Tony Caliendo
Tony Caliendo (AZ Bar No. 023138)
1930 East Brown Road Suite 103
Mesa, AZ 85203
tony@orangewoodlaw.com
Attorneys for Plaintiff

Exhibit

1

PCFB
ATTORNEYS AT LAW
Terry Jones | Registered Patent Attorney
terry@PCFBlaw.com
801.870.4092

November 28, 2023

VIA US MAIL

Luna Marie LLC
233 E Southern Ave #24573
Tempe, Arizona 85282

Re: Infringement of Remy and Roo, LLC's Intellectual Property Rights

Dear Sir or Madam:

This law firm represents Remy and Roo, LLC ("Remy+Roo") in matters relating to Remy+Roo's intellectual property, including its patents, copyrights, and trademarks. Remy+Roo takes the policing and enforcement of its intellectual property rights seriously.

Remy+Roo has learned that Luna Marie LLC ("Luna Marie") has been offering for sale unlicensed bandanas through amazon.com that appear to be covered by Remy+Roo's United States Patent No. D1,000,009 (Attached hereto). Any unauthorized making, using, offering for sale, or selling any patented invention within the United States, or importing into the United States any patented invention during the term of the patent is an infringement of the patent under 35 U.S.C. § 271 (a). Patent infringement may result in significant liabilities including being subject to preliminary and permanent injunctions and liability for substantial monetary damages.

Additionally, it has come to Remy+Roo's attention that Luna Marie has been copying and creating derivative works of various Remy+Roo copyrighted designs, such as shown in Exhibits 1-3 below. This material is protected under the United States Copyright Act and may not be reproduced or distributed without the express, written authorization of Remy+Roo. Luna Marie's violations of Remy+Roo's valuable copyrights carry serious consequences under the United States Copyright Act, 17 U.S.C. §§ 101, *et. seq.*, and subject Luna Marie to claims for injunctive relief and substantial monetary damages, including costs and attorneys' fees. Remy+Roo cannot and will not tolerate your continued violation of its intellectual property rights.

November 28, 2023
Page 2 of 7

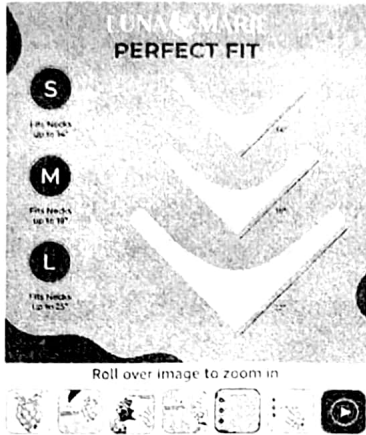

LunaMarie - Luxury Dog Bandanas - Cute Floral Designs | Premium & Silky Poly Fabric | 100% Handmade Custom Shape Dual Layered Reversible Small, Medium, Yellow Daisy (Daisies, Small)

Visit the LunaMarie Store
4.8 ★★★★★ 109 ratings

Amazon's Choice for "floral bandana dogs"

\$14.95 (\$14.95 / Count)

prime One-Day
FREE Returns

Limited Time Offer - pay **\$14.95 \$0.00** for this order. Get a **\$200 Amazon Gift Card** upon approval for the Amazon Business Prime Card. Offer ends 07/31/23. Terms apply. [Learn more.](#)

Size: **Small**

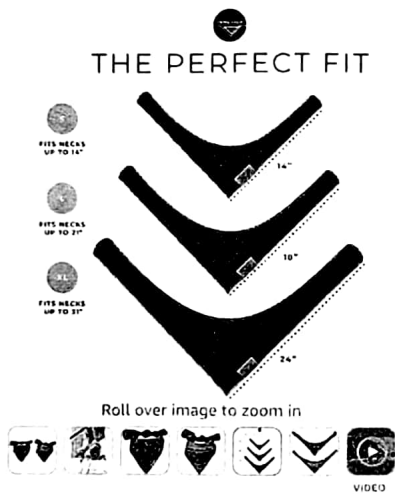

Remy+Roo Dog Bandanas - 2 Pack | Evergreen Set | Premium Durable Fabric | Unique Shape | Adjustable Fit | Multiple Sizes Offered (Large)

Visit the Remy+Roo Store
4.8 ★★★★★ 567 ratings

Amazon's Choice for "dog camping bandana"

\$18.95

prime One-Day
FREE Returns

Thank you for being a Prime member. Get a **\$100 Gift Card**: Pay **\$0.00** upon approval for Prime Visa. No annual fee.

Local Business

Size: **Large**

Target Species **Dog**

Exhibit 1

November 28, 2023
Page 3 of 7

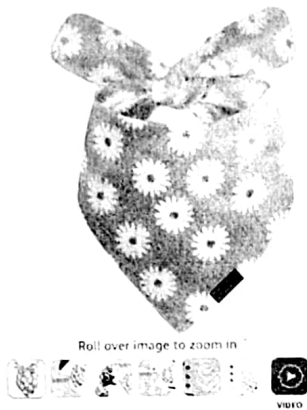

LunaMarie - Luxury Dog Bandanas - Cute Floral Designs | Premium & Silky Poly Fabric | 100% Handmade Custom Shape Dual Layered Reversible Small, Medium, Yellow Daisy (Daisies, Small)

Visit the LunaMarie Store
4.8 ★★★★★ 109 ratings
Amazon's Choice for "floral bandana dogs"

\$14.95 (\$14.95 / Count)

prime One-Day
FREE Returns

Limited Time Offer - pay \$14.95 \$0.00 for this order. Get a **\$200 Amazon Gift Card** upon approval for the Amazon Business Prime Card. Offer ends 07/31/23. Terms apply. [Learn more.](#)

Size: **Small**

Small Medium Large

Color: **Daisies**



Target Species	Dog
Size	Small
Neck Size	19 inches
Occasion	Holiday
Theme	Floral



Remy+Roo Dog Bandanas - 4 Pack | Kathrine Set | Premium Durable Polyester Fabric | Custom Unique Shape | Adjustable Fit | Girl, Cooling, Puppy, Birthday | Small, Large, XL Sizes Offered (Small)

Visit the Remy+Roo Store
4.9 ★★★★★ 1,112 ratings

\$24.95

prime One-Day
FREE Returns

Limited Time Offer - pay \$24.95 \$0.00 for this order. Get a **\$200 Amazon Gift Card** upon approval for the Amazon Business Prime Card. Offer ends 07/31/23. Terms apply. [Learn more.](#)

May be available at a lower price from other sellers, potentially without free Prime shipping.

Local Business

Size: **Small**

Small	Large	XL
\$24.95	\$24.95	\$26.95
prime	prime	prime

Target Species	Dog
Size	Small
Neck Size	13 inches
Occasion	New year, Birthday, Thanksgiving
Theme	Animals

Exhibit 2

November 28, 2023
Page 4 of 7



LunaMarie - Luxury Dog Bandanas - Cute Cheetah Designs | Premium & Silky Poly Fabric | 100% Handmade Custom Shape Dual Layered Reversible Small, Medium, Large Cat Scarf (Leopard, Small)

Visit the LunaMarie Store
4.8 ★★★★★ ~ 109 ratings

\$14.95 (\$14.95 / Count)

prime One-Day
FREE Returns

Limited Time Offer - pay ~~\$14.95~~ \$0.00 for this order. Get a \$200 Amazon Gift Card upon approval for the Amazon Business Prime Card. Offer ends 07/31/23. Terms apply. Learn more.

Size: Small

Small Medium Large

Color: Leopard



Remy+Roo Dog Bandanas - 2 Pack | Boujee Set | Premium Durable Fabric | Unique Shape | Adjustable Fit | Multiple Sizes Offered (Large)

Visit the Remy+Roo Store
4.4 ★★★★★ ~ 212 ratings

\$18.95

prime
FREE Returns

Apply now and get a \$10 Amazon Gift Card upon approval of the Prime Store Card, or see if you pre-qualify with no impact to your credit bureau score.

Local Business

Size: Large

Target Species	Dog
Size	Large
Neck Size	17 inches
Occasion	New year, Birthday, Thanksgiving
Special Feature	Lightweight, Adjustable Width, Adjustable

Exhibit 3

Furthermore, Luna Marie’s unlicensed bandanas and Luna Marie’s commercial presentation of the unlicensed bandanas on amazon.com utilize Remy+Roo’s distinctive trade dress (*i.e.*, the commercial look and feel of Remy+Roo’s products and services that identify and distinguish them) that consumers associate with Remy+Roo, which is likely to cause consumer confusion as to the products’ origin.

Remy+Roo therefore demands that Luna Marie (and any of its related companies) immediately agree to cease the unauthorized copying and reproduction and/or distribution of Remy+Roo’s copyrighted materials and/or patented designs, on the Internet, or

November 28, 2023
Page 5 of 7

otherwise, and cease utilizing Remy+Roo's distinctive trade dress. In addition, Remy+Roo demands that Luna Marie pay Remy+Roo reasonable damages for Luna Marie's infringements to date. If Luna Marie does not so agree, Remy+Roo will seek both a preliminary and permanent injunction against Luna Marie, and will seek awards of damages and attorneys' fees. Remy+Roo therefore demands that Luna Marie execute the Agreement set forth below within 20 days of the date of this letter, in order to resolve this matter without litigation.

In order that Remy+Roo may assess the damages Remy+Roo has suffered as a result of your sale of unlicensed bandanas, please provide an accounting of the number of bandanas sold or distributed by Luna Marie, and the gross revenue received by Luna Marie for the sales of unlicensed bandanas.

Remy+Roo further demands that Luna Marie cooperate with Remy+Roo by disclosing to Remy+Roo the identities and locations of any persons, entities, or sources from which Luna Marie acquired or acquires any of Remy+Roo's copyrighted materials for Luna Marie's reproduction and resale. Finally, Remy+Roo demands that, no later than December 20, 2023, Luna Marie pay to Remy+Roo by cashier's check a royalty for past infringement in an amount equal to twenty-five percent (25%) of the gross revenues received by Luna Marie from sales of any materials containing any Remy+Roo-copyrighted content. Finally, Remy+Roo demands that Luna Marie cease and desist from the advertising and/or sale of the unlicensed bandanas.

By no later than December 20, 2023, please sign and return a copy of this letter indicating Luna Marie's agreement to cease and desist from Luna Marie's intellectual property infringement, to pay Remy+Roo reasonable damages, and to comply with the other terms set forth below.

Luna Marie may be infringing or otherwise violating Remy+Roo's intellectual property rights in ways not mentioned in this letter. The list set forth above is not intended to be exhaustive, and Remy+Roo reserves the right to bring to your attention other matters that Remy+Roo believes infringe its rights.

Should you have any questions concerning Remy+Roo's position in this matter, please do not hesitate to contact me.

Very truly yours,



Terry S. Jones

TSJ

November 28, 2023
Page 6 of 7

AGREEMENT

By execution of this Agreement, the undersigned agrees immediately to cease and desist from all unauthorized uses of any Remy+Roo, copyrighted works and materials, as well as any other intellectual property of Remy+Roo, in connection with the undersigned company's products, services, advertisements, promotional literature, promotional telecasts, broadcasts, signage, on the Internet, or otherwise.

Specifically, by way of illustration and without limiting the general agreement expressed above, the undersigned agrees that it will:

- (1) immediately cease reproducing and/or using Remy+Roo's copyrighted materials in any manner, including, but not limited to, copying Remy+Roo's copyrighted fabric designs for bandanas;
- (2) immediately turn over to Remy+Roo for destruction all infringing bandanas and copyrighted products or source materials from which such infringing products can be reproduced;
- (3) immediately cease and desist from the advertisement and/or sale of the infringing bandanas.
- (5) provide the following information no later than December 20, 2023:
 - a) The number of infringing bandanas and any products containing any Remy+Roo-copyrighted content produced and/or distributed by Luna Marie or its affiliates;
 - b) the gross revenue received by Luna Marie from the sale of infringing bandanas and/or other products containing any Remy+Roo-copyrighted materials or content; and
 - c) a disclosure of the full time period during which Luna Marie has reproduced and offered for sale any infringing bandanas or other products containing any Remy+Roo-copyrighted materials or content.
- (6) no later than December 20, 2023, pay to Remy+Roo by cashier's check a royalty for past infringement in an amount equal to twenty-five percent (25%) of the gross revenues received by Luna Marie from sales of any bandanas and/or other products containing any Remy+Roo-copyrighted materials or content; and

November 28, 2023
Page 7 of 7

- (4) disclose to Remy+Roo the identities and locations of any persons, entities, or sources from which Luna Marie acquired or acquires any of Remy+Roo's copyrighted materials or content for use or reproduction by Luna Marie in its bandanas or other products.

The undersigned company further agrees and acknowledges that any violation or breach of this Agreement will cause irreparable harm to Remy+Roo, and that Remy+Roo will be entitled to both a preliminary and permanent injunction against the undersigned for any violation of this Agreement, as well as any other remedy allowed by law. The undersigned company further agrees that if it breaches this Agreement, it will pay all costs incurred by Remy+Roo in enforcing this Agreement, including reasonable attorneys' fees, whether incurred with or without suit or before or after judgment.

AGREED TO:

Luna Marie

By: _____

Its: _____

Date: _____



USOD1000009S

(12) **United States Design Patent** (10) **Patent No.:** **US D1,000,009 S**
Isom et al. (45) **Date of Patent:** **** Sep. 26, 2023**

(54) **BANDANA FOR AN ANIMAL**
 (71) Applicant: **Remy and Roo, LLC**, Provo, UT (US)
 (72) Inventors: **Andrew Isom**, Provo, UT (US); **Taylor Isom**, Provo, UT (US); **Cameron Gade**, Provo, UT (US); **Ashley Gade**, Provo, UT (US)
 (73) Assignee: **REMY AND ROO, LLC**, Provo, UT (US)

7,350,241 B2 * 4/2008 Gendall A41D 23/00
 2/9
 7,427,417 B2 * 9/2008 Jendrucko A61Q 13/00
 435/283.1
 D631,208 S * 1/2011 Gazaway D30/145
 (Continued)

FOREIGN PATENT DOCUMENTS

CH 1460450004 * 5/2021
 DE 402018203540-0004 * 1/2019
 KR 3020170000167 * 3/2017

OTHER PUBLICATIONS

Mewtogo 2 Pieces Pet Dog Cooling Collar, available in Amazon.com. date first available Mar. 31, 2020 [online]. [site visited Jul. 12, 2022], Available from the internet URI.: <https://www.amazon.com/MEWTOGO-Cooling-Collar-Lightweight-Instant/dp/B086MNQR6F> (Year: 2020).*

(Continued)

Primary Examiner — Vy N Koenig
Assistant Examiner — Elizabeth Anne Glassberg
 (74) *Attorney, Agent, or Firm* — PCFB LLC

(57) **CLAIM**

The ornamental design for a bandana for an animal, as shown and described.

DESCRIPTION

FIG. 1 is a perspective view of the design;
 FIG. 2 is a front view of the design;
 FIG. 3 is a rear view of the design;
 FIGS. 4 and 5 are side views of the design;
 FIGS. 6 and 7 are top and bottom views, respectively, of the design; and,
 FIG. 8 is another perspective view of the design in a tied configuration.
 The broken lines in the drawings depict stitching that forms part of the claimed design.

1 Claim, 3 Drawing Sheets

(**) **Term:** **15 Years**
 (21) **Appl. No.:** **29/740,838**
 (22) **Filed:** **Jul. 7, 2020**
 (51) **LOC (14) Cl.** **30-01**
 (52) **U.S. Cl.**
 USPC **D30/145; D2/500**
 (58) **Field of Classification Search**
 USPC D2/500, 861; D30/145, 152, 153
 CPC A01K 25/00; A01K 27/00; A01K 27/001;
 A01K 27/002; A01K 27/003; A01K
 27/004; A01K 27/005
 See application file for complete search history.

(56) **References Cited**

U.S. PATENT DOCUMENTS

D309,212 S * 7/1990 Maletsky D2/602
 5,465,689 A * 11/1995 Winder A01K 13/003
 119/654
 D423,150 S * 4/2000 Vignere D30/145
 D425,263 S * 5/2000 Hanada D30/145
 6,209,140 B1 * 4/2001 Ebeling A01K 27/006
 2/207
 6,523,182 B1 * 2/2003 Brawner A01K 13/006
 2/207
 D490,193 S * 5/2004 D'Anza D30/144
 D515,250 S * 2/2006 Story D30/145
 D515,278 S * 2/2006 Jendrucko D2/500
 D542,481 S * 5/2007 Katz D30/145

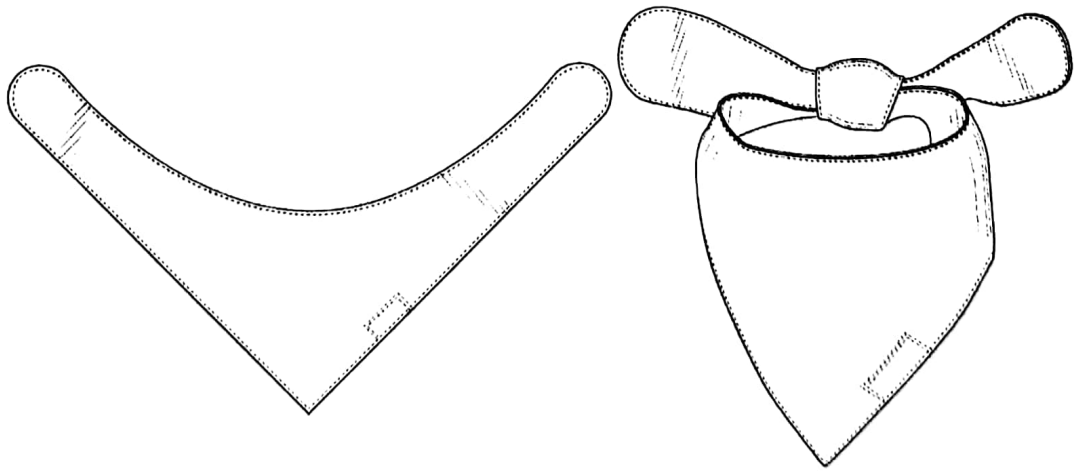

US D1,000,009 S

Page 2

(56)

References Cited

U.S. PATENT DOCUMENTS

D631,209	S *	1/2011	Gazaway	D30/145
D653,410	S *	1/2012	Morton	D30/152
D688,850	S *	9/2013	Parker	D2/881
D721,221	S *	1/2015	Frink, Sr.	D2/605
D721,471	S *	1/2015	Feinberg	D2/861
D746,556	S *	1/2016	Vifquain	D2/881
D839,533	S *	2/2019	Nardone	D29/101.2
D871,684	S *	12/2019	Searvogel	D30/152
11,324,198	B2 *	5/2022	Albert	A01K 13/006
2003/0137157	A1 *	7/2003	Hopkins	E01H 1/1206 294/1.3
2008/0092268	A1 *	4/2008	Mangham	A41D 23/00 2/129
2009/0159016	A1 *	6/2009	Lang	A01K 27/006 119/863
2010/0006039	A1 *	1/2010	Edwards	A01K 13/006 119/850
2014/0020636	A1 *	1/2014	Desaulniers	A01K 27/006 119/858

OTHER PUBLICATIONS

Remy+Roo Dog Bandanas, available in Amazon.com, date first available May 4, 2019 [online], [site visited Jul. 14, 2022], Available from the internet URL: <https://www.amazon.com/Remy-Roo-Dog-Bandanas-Adjustable/dp/B081G55N2X?th=1> (Year: 2019).*

KeaBabies Organic Baby Bandana Drool Bibs, available in Amazon.ca, date first available Nov. 9, 2018 [online], [site visited Jul. 14, 2022], Available from the internet URL: <https://www.amazon.ca/Baby-Bandana-Drool-Bibs-KeaBabies/dp/B081F3K64Y?th=1> (Year: 2018).*

* cited by examiner

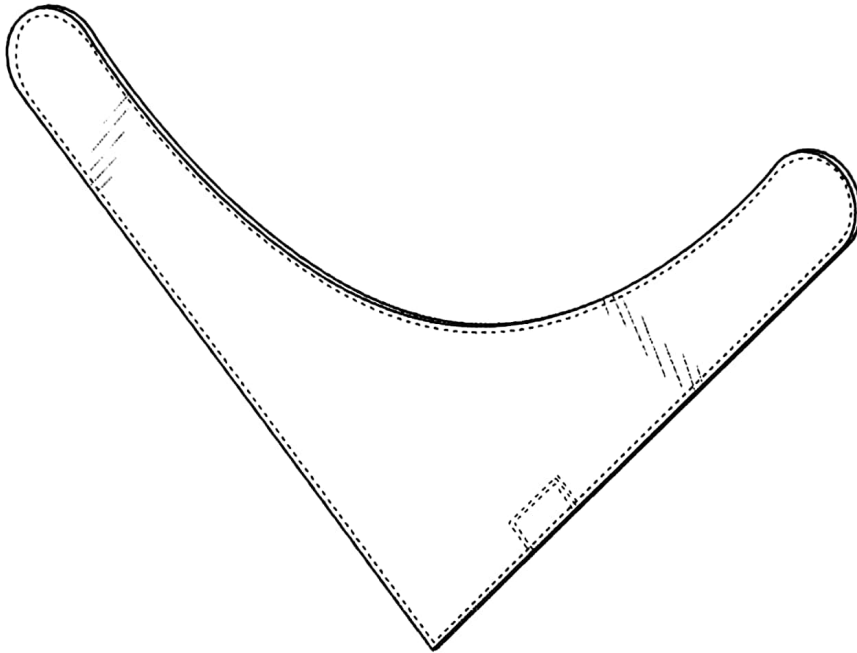

FIG. 1

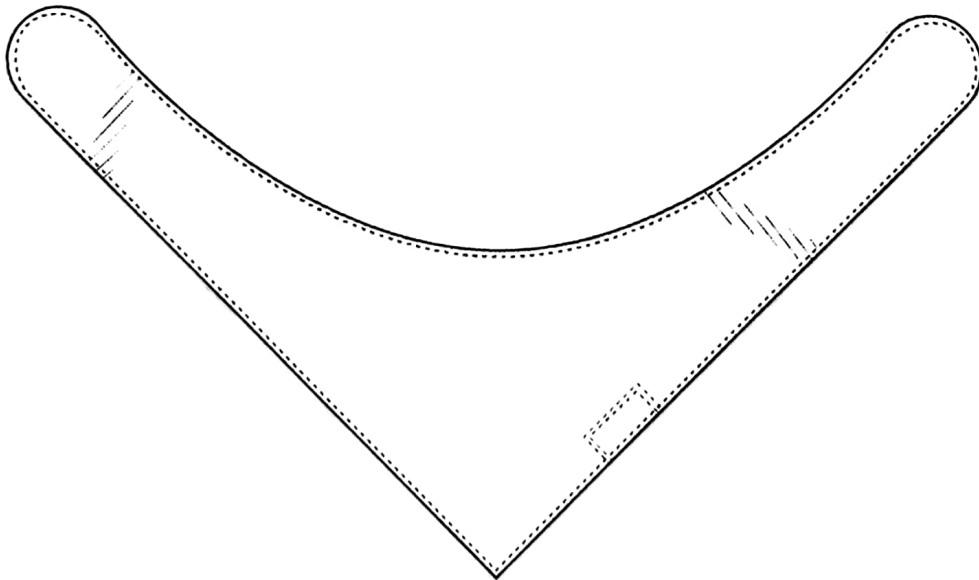

FIG. 2

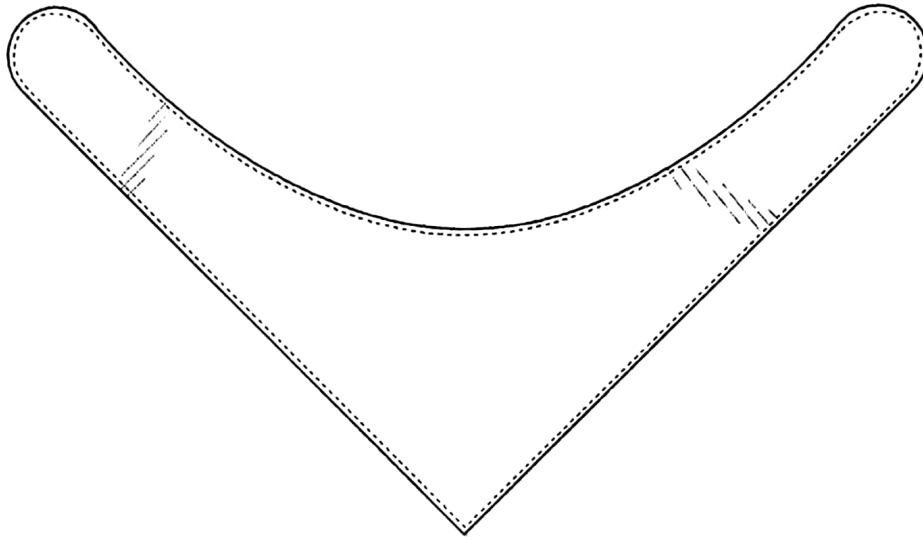

FIG. 3



FIG. 4



FIG. 5

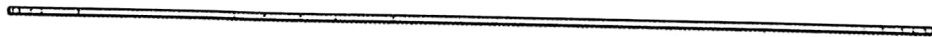

FIG. 6

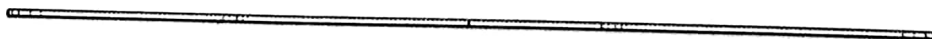

FIG. 7

U.S. Patent

Sep. 26, 2023

Sheet 3 of 3

US D1,000,009 S

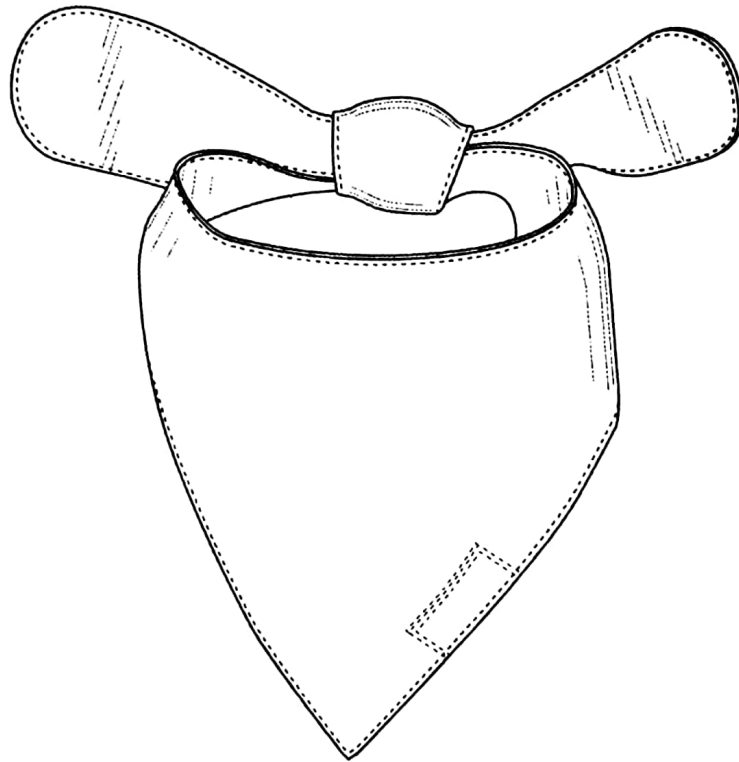

FIG. 8

Exhibit

2

PATENT
Attorney Docket RR.1000US

VIA ELECTRONIC FILING

APPLICATION FOR DESIGN PATENT

for

BANDANA FOR AN ANIMAL

Inventors:

Andrew Isom
Taylor Isom
Cameron Gade
Ashley Gade

Attorney:
Gregory C. Baker
Reg. No. 61,335
PHILLIPS WINCHESTER
4001 South 700 East, Suite 500
Salt Lake City, Utah 84107
Telephone: (801) 935-4935

SPECIFICATION FOR
DESIGN PATENT APPLICATION

TO THE COMMISSIONER OF PATENTS AND TRADEMARKS
AND TO ALL WHOM IT MAY CONCERN

[0001] Be it known that we, Andrew Isom, Taylor Isom, Cameron Gade, and Ashley Gade, have invented a new, original, and ornamental design for a BANDANA FOR AN ANIMAL of which the following is a specification, reference being had to the accompanying drawings forming a part hereof.

DESCRIPTION OF THE DRAWINGS

[0002] FIG. 1 is a perspective view of the design in accordance with an embodiment of the disclosure;

[0003] FIG. 2 is a front view of the design;

[0004] FIG. 3 is a rear view of the design;

[0005] FIGS. 4 and 5 are side views of the design;

[0006] FIGS. 6 and 7 are top and bottom views, respectively, of the design; and

[0007] FIG. 8 is another perspective view of the design in a tied configuration in accordance with an embodiment of the disclosure.

WE CLAIM:

The ornamental design for a BANDANA FOR AN ANIMAL as shown and described.

+

1/3

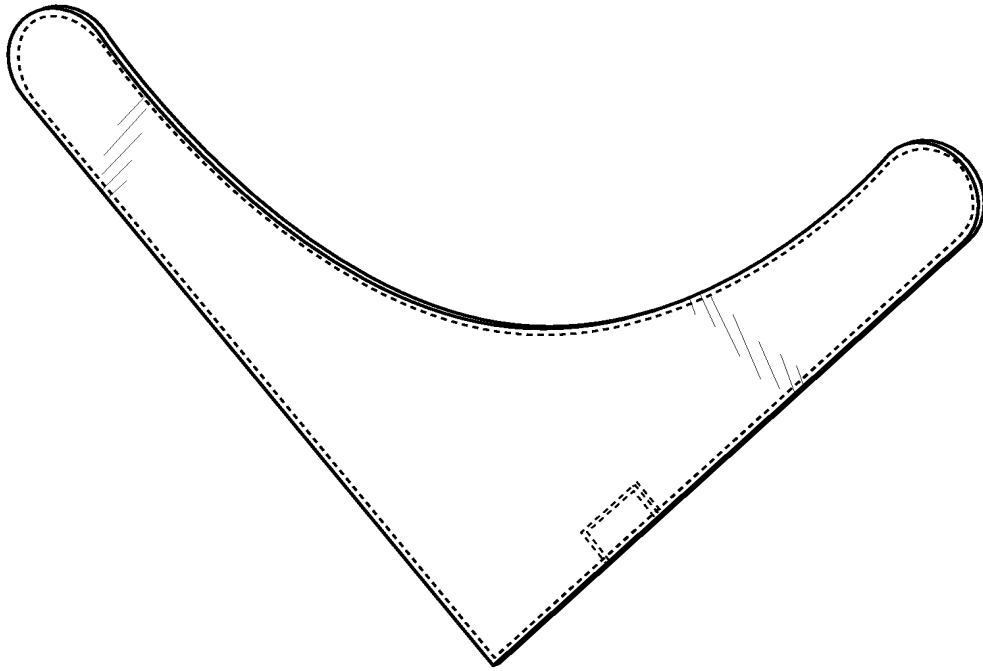

FIG. 1

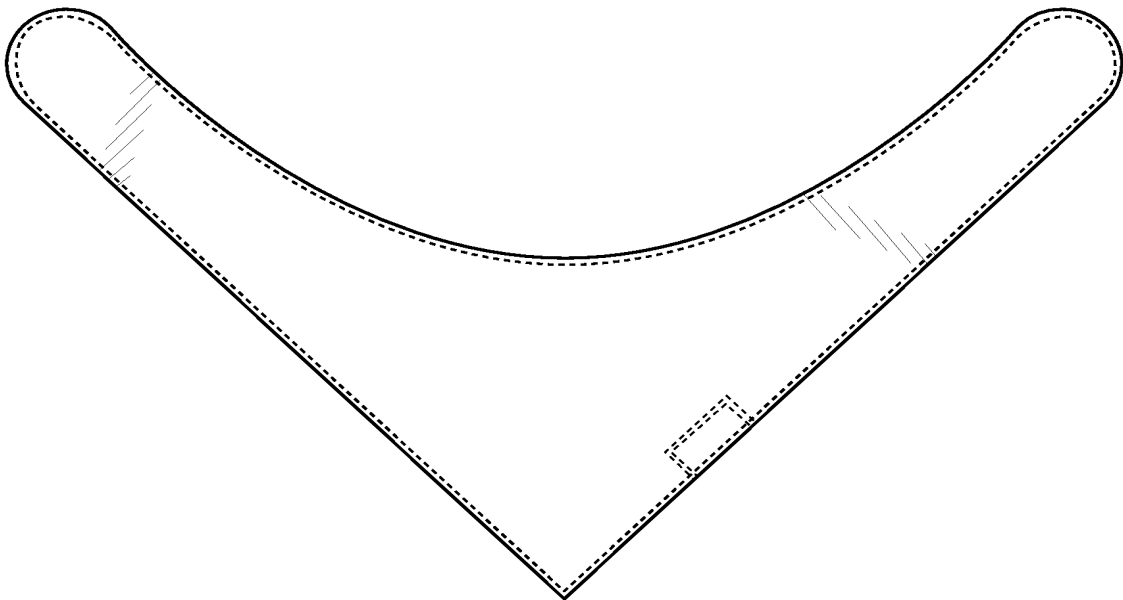

FIG. 2

+

+

2/3

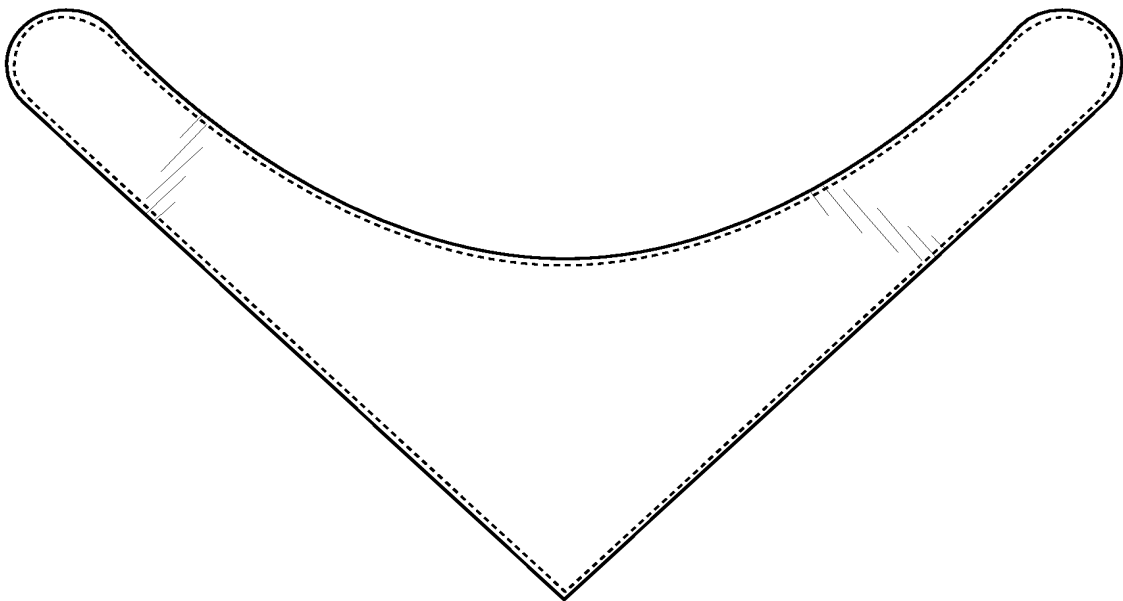

FIG. 3



FIG. 4



FIG. 5



FIG. 6



FIG. 7

+

+

3/3

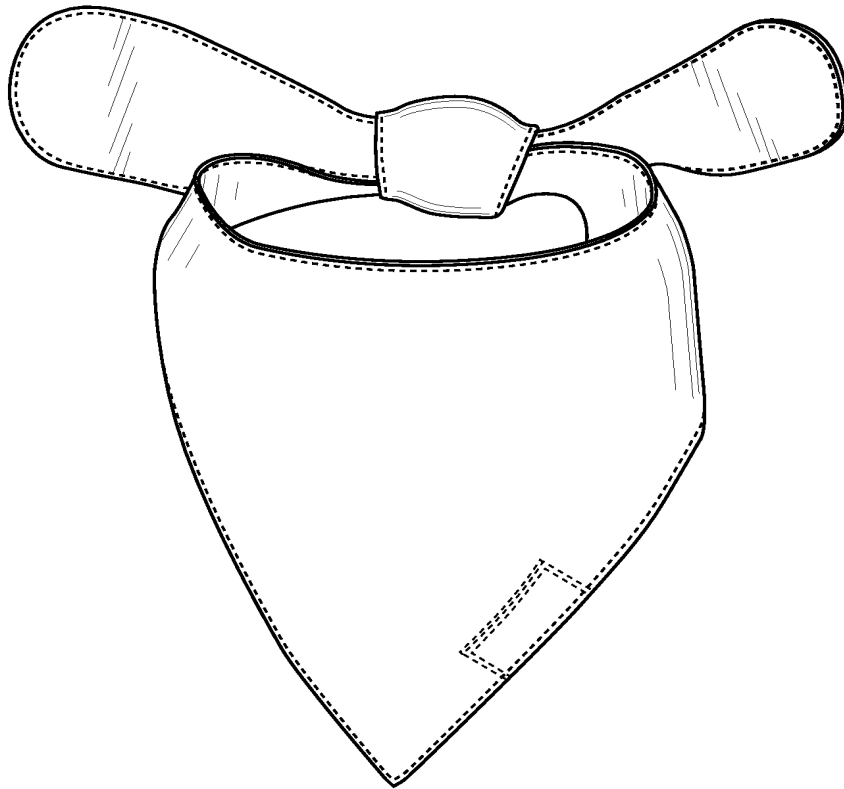

FIG. 8

+

Exhibit

3



UNITED STATES DEPARTMENT OF COMMERCE
 United States Patent and Trademark Office
 Address: COMMISSIONER FOR PATENTS
 P.O. Box 1450
 Alexandria, Virginia 22313-1450
 www.uspto.gov

APPLICATION NO.	FILING DATE	FIRST NAMED INVENTOR	ATTORNEY DOCKET NO.	CONFIRMATION NO.
29/740,838	07/07/2020	Andrew Isom	RR.1000US	2459
102983	7590	07/21/2022	EXAMINER	
Phillips Winchester 4001 South 700 East, Suite 500 Salt Lake City, UT 84107			GLASSBERG, ELIZABETH ANNE	
			ART UNIT	PAPER NUMBER
			2925	
			NOTIFICATION DATE	DELIVERY MODE
			07/21/2022	ELECTRONIC

Please find below and/or attached an Office communication concerning this application or proceeding.

The time period for reply, if any, is set in the attached communication.

Notice of the Office communication was sent electronically on above-indicated "Notification Date" to the following e-mail address(es):

- ahc@phillipswinchester.com
- gcb@phillipswinchester.com
- jlc@phillipswinchester.com

OFFICE ACTION

The present application, filed on or after March 16, 2013, is being examined under the first inventor to file provisions of the AIA.

Specification Objections

- **Figure Descriptions:** Descriptions of the figures are not required to be written in any particular format, however, they must describe the views of the drawing clearly and accurately (MPEP 1503.01(II)). There is only one embodiment in the claim. Accordingly, for accuracy, the descriptions of figure 1 and figure 8 should be amended as follows:
**-- FIG. 1 is a perspective view of the design;
FIG. 8 is another perspective view of the design in a tied configuration. --**
- **Missing Feature Descriptions:** the drawings show evenly spaced broken lines adjacent the entire edge of the bandana. In addition, there is also a rectangular feature at the front of the bandana that is outlined in broken lines of a lighter line weight than the ones along the edge. Broken lines are most often used for one of three purposes:
 - 1) To disclaim regions within a claimed design (i.e. boundaries),
 - 2) To show environmental subject matter - within a broken line boundary, outside of a claimed design, or superimposed upon a claimed surface (wherein the underlying surface is claimed).
 - 3) To show stitching on garments and linens that either form part of the claim or form no part of the claim.As it is possible that broken lines with different purposes may be included in a single application, the description must make a visual distinction between the two purposes. See MPEP § 1503.02 (III).

The examiner understands the broken lines along the edges of the bandana as illustrating stitching. However, the applicant should add a broken lines statement to the specification stating whether the broken lines form part of the claim or not and another statement stating whether the broken lines outline of a rectangle form part of the claim or not. MPEP § 1503.02 (III). The following is suggested if the broken lines along the edge are part of the claim but the rectangular feature is not part of the claim:

-- The broken lines along the edges of the bandana in the figures illustrate stitching that forms part of the claimed design. While the broken lines rectangular feature at the front of the bandana forms no part of the claimed design. --

Rejection – 35 U.S.C. § 103

The claim is rejected under 35 U.S.C. § 103 as being unpatentable over Remy+Roo Dog Bandanas, published: 05/04/2019 (“Remy”, NPL Reference V), in view of KeaBabies Organic Baby Bandana Drool Bibs, published: 11/09/2018 (“KeaBabies”, NPL Reference W).

Although the invention is not identically disclosed or described as set forth in 35 U.S.C. § 102, if the differences between the claimed invention and the prior art are such that the claimed invention as a whole would have been obvious before the effective filing date of the claimed invention to a designer having ordinary skill in the art to which the claimed invention pertains, the invention is not patentable.

In a proper rejection of a design claim under 35 U.S.C. § 103, there must be a reference (the basic design), a something in existence, the design characteristics of which are basically the same as the claimed design in order to support a holding of obviousness. In other words, the basic reference design must look something like the claimed design. *In re Harvey*, 12 F.3d 1061, 1063, 29 USPQ 1206, 1208 (Fed. Cir. 1993) and *In re Rosen*, 673 F.2d 388, 391, 213 USPQ 347, 350 (CCPA 1982). Once such a design has been established, features thereof may reasonably be interchanged with or added from those in other pertinent references to achieve the claimed design. Such modifications, however, cannot destroy the fundamental characteristics of the basic design reference.

The bandana of Remy has design characteristics that are basically the same as the claimed design: It has an overall triangular shape with the front bottom having straight edges on the left and right side that come to a point at the center of the garment. The top edge is curved such that the left and right sides at the top narrow to form straps. The claimed design differs from Remy in that the straps on Remy are longer and are more squared off at the ends while the claimed design has straps that are shorter in proportion to the body and are round at the ends. KeaBabies shows a triangular bandana with a curved top that has shorter straps that are round at the ends. See examples below.

Application/Control Number: 29/740,838
 Art Unit: 2925

Page 4

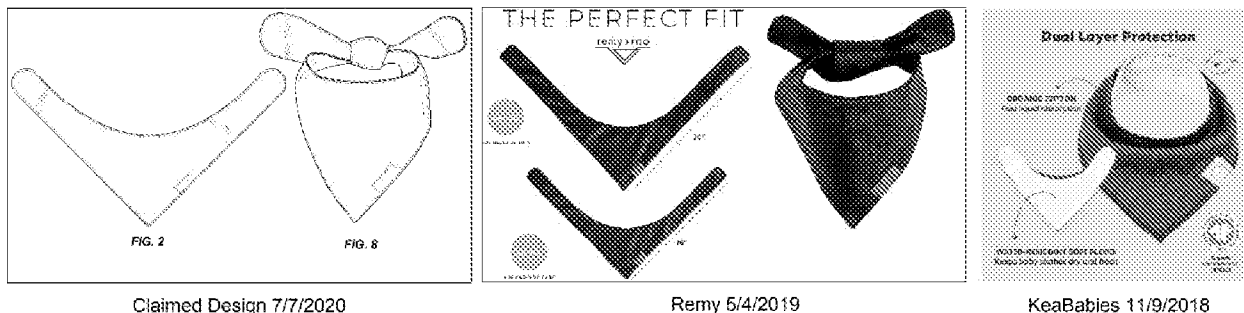

It would have been obvious to one of ordinary skill in the art at the time the invention was made to modify the bandana of Remy by making it with shorter straps with ends that are round as taught by KeaBabies.

The claimed design would have no patentable distinction over the Examiner's combination of references. Obviousness, like anticipation, requires courts to consider the perspective of the ordinary observer. Comparing the claimed design with the Examiner's combination of references takes into account significant differences between the two designs, not minor or trivial differences that necessarily exist between any two designs that are not exact copies of one another. Just as "minor differences between a patented design and an accused article's design cannot, and shall not, prevent a finding of infringement," (*Litton*, 728 F.2d at 1444), so too minor differences cannot prevent a finding of anticipation. (*International Seaway Trading Corp. v. Walgreens Corp.*, 93 USPQ2d 1001 (Fed. Cir. 2009).)

This modification of the primary reference in light of the secondary reference is proper because the applied references are so related that the appearance of features shown in one would suggest the application of those features to the other. See *In re Rosen*, 673 F.2d 388, 213 USPQ 347 (CCPA 1982); *In re Carter*, 673 F.2d 1378, 213 USPQ 625 (CCPA 1982), and *In re Glavas*, 230 F.2d 447, 109 USPQ 50 (CCPA 1956). Further, it is noted that case law has held that one skilled in the art is charged with knowledge of the related art; therefore, the combination of old elements, herein, would have been well within the level of ordinary skill. See *In re Antle*, 444 F.2d 1168, 170 USPQ 285 (CCPA 1961) and *In re Nalbandian*, 661 F.2d 1214, 211 USPQ 782 (CCPA 1982).

Conclusion

The claim stands rejected under 35 U.S.C. § 103.

Application/Control Number: 29/740,838

Page 5

Art Unit: 2925

Contact

Any inquiry concerning this communication or earlier communications from the examiner should be directed to ELIZABETH ANNE GLASSBERG whose telephone number is (571)272-9934. The examiner can normally be reached Monday-Friday 9am-5pm EST. Examiner interviews are available via telephone, in-person, and video conferencing using a USPTO supplied web-based collaboration tool. To schedule an interview, applicant is encouraged to use the USPTO Automated Interview Request (AIR) at <http://www.uspto.gov/interviewpractice>. If attempts to reach the examiner by telephone are unsuccessful, the examiner's supervisor, Dana K WEILAND can be reached on (571)270-0253. The fax phone number for the organization where this application or proceeding is assigned is 571-273-8300.

Information regarding the status of published or unpublished applications may be obtained from Patent Center. Unpublished application information in Patent Center is available to registered users. To file and manage patent submissions in Patent Center, visit: <https://patentcenter.uspto.gov>. Visit <https://www.uspto.gov/patents/apply/patent-center> for more information about Patent Center and <https://www.uspto.gov/patents/docx> for information about filing in DOCX format. For additional questions, contact the Electronic Business Center (EBC) at 866-217-9197 (toll-free). If you would like assistance from a USPTO Customer Service Representative, call 800-786-9199 (IN USA OR CANADA) or 571-272-1000.

/E.A.G./

Examiner, Art Unit 2925

/JENNIFER L REMPFER/

Primary Examiner, Art Unit 2919

Notice of References Cited	Application/Control No. 29/740,838	Applicant(s)/Patent Under Reexamination Isom et al.	
	Examiner ELIZABETH A GLASSBERG	Art Unit 2925	Page 1 of 2

U.S. PATENT DOCUMENTS

*		Document Number Country Code-Number-Kind Code	Date MM-YYYY	Name	CPC Classification	US Classification
*	A	US-D309212-S	07-1990	Maletsky; Jerry		D2/602
*	B	US-5465689-A	11-1995	Winder; Forrest	A01K13/003	119/654
*	C	US-D423150-S	04-2000	Vignere; Judith Ann		D30/145
*	D	US-D425263-S	05-2000	Hanada; Toyohiro		D30/145
*	E	US-6209140-B1	04-2001	Ebeling; Lorraine A.	A01K27/006	2/207
*	F	US-6523182-B1	02-2003	Brawner; Sara	A01K13/006	2/207
*	G	US-20030137157-A1	07-2003	Hopkins, Kenneth C.	E01H1/1206	294/1.3
*	H	US-D490193-S	05-2004	D'Anza; Ellen		D30/144
*	I	US-D515278-S	02-2006	Jendrucko; Mary L.		D2/500
*	J	US-D542481-S	05-2007	Katz; Bette J.		D30/145
*	K	US-7350241-B2	04-2008	Gendall; Alex K.	A41D23/00	2/9
*	L	US-20080092268-A1	04-2008	Mangham; James	A41D23/00	2/129
*	M	US-7427417-B2	09-2008	Jendrucko; Mary L.	A61Q13/00	435/283.1

FOREIGN PATENT DOCUMENTS

*		Document Number Country Code-Number-Kind Code	Date MM-YYYY	Country	Name	CPC Classification
	N	1460450004	05-2021	CH	Vögeli et al.	
	O	402018203540-0004	01-2019	DE	Krolzig; Marilyn	
	P	3020170000167	03-2017	KR	Lee; Gongju	
	Q					
	R					
	S					
	T					

NON-PATENT DOCUMENTS

*		Include as applicable: Author, Title Date, Publisher, Edition or Volume, Pertinent Pages)
	U	Mewtogo 2 Pieces Pet Dog Cooling Collar, available in Amazon.com, date first available March 31, 2020 [online], [site visited 7/12/22], Available from the internet URL: https://www.amazon.com/MEWTOGO-Cooling-Collar-Lightweight-Instant/dp/B086MNQR6F (Year: 2020)
	V	Remy+Roo Dog Bandanas, available in Amazon.com, date first available May 4, 2019 [online], [site visited 7/14/22], Available from the internet URL: https://www.amazon.com/Remy-Roo-Dog-Bandanas-Adjustable/dp/B08LG55N2X?th=1 (Year: 2019)
	W	KeaBabies Organic Baby Bandana Drool Bibs, available in Amazon.ca, date first available Nov. 9 2018 [online], [site visited 7/14/22], Available from the internet URL: https://www.amazon.ca/Baby-Bandana-Drool-Bibs-KeaBabies/dp/B081F3K64Y?th=1 (Year: 2018)
	X	

*A copy of this reference is not being furnished with this Office action. (See MPEP § 707.05(a).)
Dates in MM-YYYY format are publication dates. Classifications may be US or foreign.

Notice of References Cited	Application/Control No. 29/740,838		Applicant(s)/Patent Under Reexamination Isom et al.	
	Examiner ELIZABETH A GLASSBERG		Art Unit 2925	Page 2 of 2

U.S. PATENT DOCUMENTS

*		Document Number Country Code-Number-Kind Code	Date MM-YYYY	Name	CPC Classification	US Classification
*	A	US-20090159016-A1	06-2009	Lang; Rebecca Marie	A01K27/006	119/863
*	B	US-20100006039-A1	01-2010	Edwards; Maureen L.	A01K13/006	119/850
*	C	US-D631209-S	01-2011	Gazaway; Joy F. G.		D30/145
*	D	US-D631208-S	01-2011	Gazaway; Joy F. G.		D30/145
*	E	US-D653410-S	01-2012	Morton; Jennifer		D30/152
*	F	US-D688850-S	09-2013	Parker; Nicole Ari		D2/881
*	G	US-20140020636-A1	01-2014	Desaulniers; Karen	A01K27/006	119/858
*	H	US-D721471-S	01-2015	Feinberg; Jason		D2/861
*	I	US-D721221-S	01-2015	Frink, Sr.; Cleave		D2/605
*	J	US-D746556-S	01-2016	Vifquain; Tina Marie		D2/881
*	K	US-D839533-S	02-2019	Nardone; Thomas Michael		D29/101.2
*	L	US-D871684-S	12-2019	Searvogel; Breanna		D30/152
*	M	US-11324198-B2	05-2022	Albert; Allison	A01K13/006	1/1

FOREIGN PATENT DOCUMENTS

*		Document Number Country Code-Number-Kind Code	Date MM-YYYY	Country	Name	CPC Classification
	N					
	O					
	P					
	Q					
	R					
	S					
	T					

NON-PATENT DOCUMENTS

*		Include as applicable: Author, Title Date, Publisher, Edition or Volume, Pertinent Pages)
	U	
	V	
	W	
	X	

*A copy of this reference is not being furnished with this Office action. (See MPEP § 707.05(a).)
 Dates in MM-YYYY format are publication dates. Classifications may be US or foreign.

Exhibit

4

IN THE UNITED STATES PATENT AND TRADEMARK OFFICE

In re application of

Andrew Isom

Application No. 29/740,838

Filed: July 7, 2020

For: **BANDANA FOR AN ANIMAL**

Group Art Unit: 2925

Confirmation No. 2459

Examiner: GLASSBERG, ELIZABETH ANNE

AMENDMENT AND RESPONSE TO NON-FINAL OFFICE ACTION

TO THE COMMISSIONER FOR PATENTS:

In response to the Office Action mailed July 21, 2022, please amend the above-identified patent application as follows.

Amendments to the **Specification** appear on page 2 of this paper

Remarks appear on page 3 of this paper.

U.S. Patent Application No. 29/740,838

IN THE SPECIFICATION:

Please amend paragraph [0002], as follows:

[0002] FIG. 1 is a perspective view of the design ~~in accordance with an embodiment of the disclosure;~~

Please amend paragraph [0007], as follows:

[0007] FIG. 8 is another perspective view of the design in a tied configuration ~~in accordance with an embodiment of the disclosure.~~

After paragraph [0007], please insert the following paragraph:

[0007] The broken lines in the drawings depict stitching that forms part of the claimed design.

U.S. Patent Application No. 29/740,838

REMARKS

This amendment is filed in response to the Office Action mailed July 21, 2022.

For at least the reasons presented below, Applicant respectfully submits that the pending claim, with the drawings amended herein, is in condition for allowance.

Specification Objections

As shown, the Specification has been amended to address the items in the Office Action. Thus, the objection should be withdrawn.

35 U.S.C. § 103 Rejection

Initially, with regard to the “Remy” reference, the Office Action cites a dynamic website from July 14, 2022 and assigns the current contents (namely, photos of a product) of the dynamic website to the purported “Date First Available” that is also listed on the website. However, the Office Action has made no showing that the photos viewed on the website in July 2022 were actually present on the dynamic website on the alleged assigned publication date of May 2, 2019.

Thus, in the absence of an actual archived image from the website that matches the purported publication date or any other evidence of the actual contents of the dynamic website on the alleged publication date, the rejection appears to lack basis and should be withdrawn.

Notwithstanding the above, Applicant further provides herewith the Declaration of Andrew Isom that sets out the known facts related to the purported publication date. As indicated by Mr. Isom’s Declaration, regardless of the actual content of the website, the earliest publication date appears to be on or after July 8, 2019 and not the incorrectly relied on date of May 2, 2019.

Accordingly, the Remy reference does not appear to qualify as prior art as the content of this website was “made 1 year or less before the effective filing date of [the] claimed invention” where “the disclosure was made by the inventor or joint inventor or by another who obtained the subject matter disclosed directly or indirectly from the inventor or a joint inventor.” 35 U.S.C. § 102(b)(1)(A) as set forth in Mr. Isom’s Declaration.

Thus, the rejection should be withdrawn.

U.S. Patent Application No. 29/740,838

Conclusion

In view of the foregoing, Applicant believes that the application is in condition for allowance. The issuance of a formal Notice of Allowance at an early date is respectfully requested.

If the Examiner believes a telephone conference would expedite prosecution of this application, please contact the undersigned at (801) 935-4935.

Respectfully submitted,

By: /Gregory C. Baker/
Gregory C. Baker
Registration No. 61,335
PHILLIPS WINCHESTER
4001 South 700 East, Suite 500
Salt Lake City, UT 84017
Telephone: (801) 935-4935
Facsimile: (801) 935-4936

Exhibit

5



UNITED STATES DEPARTMENT OF COMMERCE
 United States Patent and Trademark Office
 Address: COMMISSIONER FOR PATENTS
 P.O. Box 1450
 Alexandria, Virginia 22313-1450
 www.uspto.gov

APPLICATION NO.	FILING DATE	FIRST NAMED INVENTOR	ATTORNEY DOCKET NO.	CONFIRMATION NO.
29/740,838	07/07/2020	Andrew Isom	RR.1000US	2459
102983 PCFB 4001 South 700 East, Suite 500 Salt Lake City, UT 84107	7590 11/08/2022		EXAMINER GLASSBERG, ELIZABETH ANNE	
			ART UNIT 2925	PAPER NUMBER
			NOTIFICATION DATE 11/08/2022	DELIVERY MODE ELECTRONIC

Please find below and/or attached an Office communication concerning this application or proceeding.

The time period for reply, if any, is set in the attached communication.

Notice of the Office communication was sent electronically on above-indicated "Notification Date" to the following e-mail address(es):

april@pcfblaw.com
 greg@pcfblaw.com
 jared@pcfblaw.com

Office Action Summary**Application No.**

29/740,838

Applicant(s)

Isom et al.

Examiner

ELIZABETH A GLASSBERG

Art Unit

2925

AIA (FITF) Status

Yes

-- The MAILING DATE of this communication appears on the cover sheet with the correspondence address --**Period for Reply**

A SHORTENED STATUTORY PERIOD FOR REPLY IS SET TO EXPIRE 3 MONTHS FROM THE MAILING DATE OF THIS COMMUNICATION.

- Extensions of time may be available under the provisions of 37 CFR 1.136(a). In no event, however, may a reply be timely filed after SIX (6) MONTHS from the mailing date of this communication.
- If NO period for reply is specified above, the maximum statutory period will apply and will expire SIX (6) MONTHS from the mailing date of this communication.
- Failure to reply within the set or extended period for reply will, by statute, cause the application to become ABANDONED (35 U.S.C. § 133). Any reply received by the Office later than three months after the mailing date of this communication, even if timely filed, may reduce any earned patent term adjustment. See 37 CFR 1.704(b).

Status

1) Responsive to communication(s) filed on 13 October 2022 Amendment.

A declaration(s)/affidavit(s) under **37 CFR 1.130(b)** was/were filed on _____.

2a) This action is **FINAL**.

2b) This action is non-final.

3) An election was made by the applicant in response to a restriction requirement set forth during the interview on _____; the restriction requirement and election have been incorporated into this action.

4) Since this application is in condition for allowance except for formal matters, prosecution as to the merits is closed in accordance with the practice under *Ex parte Quayle*, 1935 C.D. 11, 453 O.G. 213.

Disposition of Claims*

5) Claim(s) 1 is/are pending in the application.

5a) Of the above claim(s) _____ is/are withdrawn from consideration.

6) Claim(s) _____ is/are allowed.

7) Claim(s) 1 is/are rejected.

8) Claim(s) _____ is/are objected to.

9) Claim(s) _____ are subject to restriction and/or election requirement

* If any claims have been determined allowable, you may be eligible to benefit from the **Patent Prosecution Highway** program at a participating intellectual property office for the corresponding application. For more information, please see http://www.uspto.gov/patents/init_events/pph/index.jsp or send an inquiry to PPHfeedback@uspto.gov.

Application Papers

10) The specification is objected to by the Examiner.

11) The drawing(s) filed on 07 July 2020 is/are: a) accepted or b) objected to by the Examiner.

Applicant may not request that any objection to the drawing(s) be held in abeyance. See 37 CFR 1.85(a).

Replacement drawing sheet(s) including the correction is required if the drawing(s) is objected to. See 37 CFR 1.121(d).

Priority under 35 U.S.C. § 119

12) Acknowledgment is made of a claim for foreign priority under 35 U.S.C. § 119(a)-(d) or (f).

Certified copies:

a) All b) Some** c) None of the:

1. Certified copies of the priority documents have been received.

2. Certified copies of the priority documents have been received in Application No. _____.

3. Copies of the certified copies of the priority documents have been received in this National Stage application from the International Bureau (PCT Rule 17.2(a)).

** See the attached detailed Office action for a list of the certified copies not received.

Attachment(s)

1) Notice of References Cited (PTO-892)

3) Interview Summary (PTO-413)

Paper No(s)/Mail Date _____.

2) Information Disclosure Statement(s) (PTO/SB/08a and/or PTO/SB/08b)

4) Other: _____.

Paper No(s)/Mail Date _____.

Application/Control Number: 29/740,838
Art Unit: 2925

Page 2

DETAILED ACTION

The present application, filed on or after March 16, 2013, is being examined under the first inventor to file provisions of the AIA.

Examiner's Comment

Applicant's Amendments submitted on 10/13/2022 in response to the Non-final Rejection are hereby acknowledged. The objections to the Specification have been overcome and are withdrawn. The rejection under 35 U.S.C. § 103 has been carefully considered in view of Applicant's response and amendments; although it is the Examiner's position that the rejection has not been overcome by Applicant's response, the rejection is withdrawn. Upon further search for prior art, new non-final rejections under 35 U.S.C. § 103 are detailed further down in this office action.

The affidavit submitted by the applicant appears incomplete as it does not provide convincing evidence (for example a copy of the contract to sell the product on Amazon or a printout of the Amazon product page with a date on it) and evidence that the disclosure was made by the inventor and was made one year or less before the effective filing date of the claimed invention.

As set forth in 37 CFR 1.130(b), an appropriate affidavit or declaration under this paragraph must identify the subject matter publicly disclosed and provide the date such subject matter was publicly disclosed by the inventor or a joint inventor or another who obtained the subject matter disclosed directly or indirectly from the inventor or a joint inventor. Additionally, 37 CFR 1.130(b)(1) states that if the subject matter publicly disclosed on that date was in a printed publication, the affidavit or declaration must be accompanied by a copy of the printed publication or (2) If the subject matter publicly disclosed on that date was not in a printed publication, the affidavit or declaration must describe the subject matter with sufficient detail and particularity to determine what subject matter had been publicly disclosed on that date by the inventor or a joint inventor or another who obtained the subject matter disclosed directly or indirectly from the inventor or a joint inventor.

The declaration alone is insufficient to overcome the 35 U.S.C. § 103 rejection because it does not meet the criteria set forth in 37 CFR 1.130(b) in order to acquire an exception; however as previously stated, the rejection is withdrawn.

Application/Control Number: 29/740,838
Art Unit: 2925

Page 3

Rejection – 35 U.S.C. § 103

The claim is rejected under 35 U.S.C. § 103 as being unpatentable over U.S. patent number D515250 to Story on 02/14/2006; in view of U.S. patent number D631208 to Gazaway on 01/18/2011.

Although the invention is not identically disclosed or described as set forth in 35 U.S.C. § 102, if the differences between the claimed invention and the prior art are such that the claimed invention as a whole would have been obvious before the effective filing date of the claimed invention to a designer having ordinary skill in the art to which the claimed invention pertains, the invention is not patentable.

In a proper rejection of a design claim under 35 U.S.C. § 103, there must be a reference (the basic design), a something in existence, the design characteristics of which are basically the same as the claimed design in order to support a holding of obviousness. In other words, the basic reference design must look something like the claimed design. *In re Harvey*, 12 F.3d 1061, 1063, 29 USPQ 1206, 1208 (Fed. Cir. 1993) and *In re Rosen*, 673 F.2d 388, 391, 213 USPQ 347, 350 (CCPA 1982). Once such a design has been established, features thereof may reasonably be interchanged with or added from those in other pertinent references to achieve the claimed design. Such modifications, however, cannot destroy the fundamental characteristics of the basic design reference.

The bandana of Story has design characteristics that are basically the same as the claimed design: It has an overall triangular shape with the left and right sides that are straight come to a 90 degree point at the bottom center of the garment. The top edge curves downward and the left and right sides narrow toward the top to form straps. The claimed design differs from Story in that the straps on Story are narrower in proportion to the rest of the body, not of the same length, and ends of the straps have an angled squared off edge; while the claimed design has straps that are wider in proportion to the rest of the body, they are of equal length, and are round at the ends. Gazaway shows a bandana with straps that are wider in proportion to the rest of the body, of equal length, and are round at the ends. A de minimis difference between the claimed design and the prior art is that the claimed design has stitching all along the edges and a small rectangular stitched feature on the right front side near the point. This minor difference does not create a patentably distinct design. See MPEP 1504.03(B). See examples below.

Application/Control Number: 29/740,838
 Art Unit: 2925

Page 4

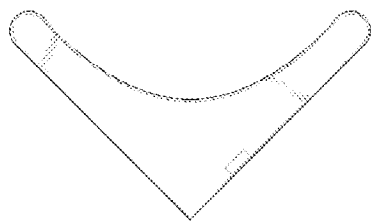

FIG. 2

Claimed Design 7/7/2020

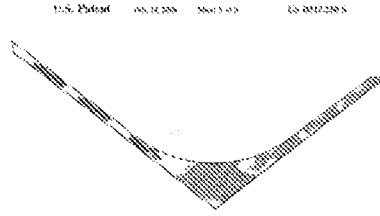

FIG. 1

Story 02/14/2006

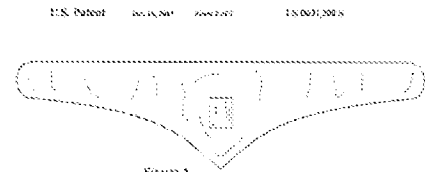

Figure 1

Gazaway 01/18/2011

It would have been obvious to one of ordinary skill in the art at the time the invention was made to modify the bandana of Story by making it with wider straps of equal length that have round ends as taught by Gazaway.

The claimed design would have no patentable distinction over the Examiner's combination of references. Obviousness, like anticipation, requires courts to consider the perspective of the ordinary observer. Comparing the claimed design with the Examiner's combination of references takes into account significant differences between the two designs, not minor or trivial differences that necessarily exist between any two designs that are not exact copies of one another. Just as "minor differences between a patented design and an accused article's design cannot, and shall not, prevent a finding of infringement," (*Litton*, 728 F.2d at 1444), so too minor differences cannot prevent a finding of anticipation. (*International Seaway Trading Corp. v. Walgreens Corp.*, 93 USPQ2d 1001 (Fed. Cir. 2009).)

This modification of the primary reference in light of the secondary reference is proper because the applied references are so related that the appearance of features shown in one would suggest the application of those features to the other. See *In re Rosen*, 673 F.2d 388, 213 USPQ 347 (CCPA 1982); *In re Carter*, 673 F.2d 1378, 213 USPQ 625 (CCPA 1982), and *In re Glavas*, 230 F.2d 447, 109 USPQ 50 (CCPA 1956). Further, it is noted that case law has held that one skilled in the art is charged with knowledge of the related art; therefore, the combination of old elements, herein, would have been well within the level of ordinary skill. See *In re Antle*, 444 F.2d 1168, 170 USPQ 285 (CCPA 1961) and *In re Nalbandian*, 661 F.2d 1214, 211 USPQ 782 (CCPA 1982).

Rejection – 35 U.S.C. § 103

The claim is rejected under 35 U.S.C. § 103 as being unpatentable over U.S. patent number D309212 to Maletsky, et al on 07/17/1990; in view of U.S. patent number D631208 to Gazaway on 01/18/2011.

Although the invention is not identically disclosed or described as set forth in 35 U.S.C. § 102, if the differences between the claimed invention and the prior art are such that the claimed invention as a whole would have been obvious before the effective filing date of the claimed invention to a designer having ordinary skill in the art to which the claimed invention pertains, the invention is not patentable.

In a proper rejection of a design claim under 35 U.S.C. § 103, there must be a reference (the basic design), a something in existence, the design characteristics of which are basically the same as the claimed design in order to support a holding of obviousness. In other words, the basic reference design must look something like the claimed design. *In re Harvey*, 12 F.3d 1061, 1063, 29 USPQ 1206, 1208 (Fed. Cir. 1993) and *In re Rosen*, 673 F.2d 388, 391, 213 USPQ 347, 350 (CCPA 1982). Once such a design has been established, features thereof may reasonably be interchanged with or added from those in other pertinent references to achieve the claimed design. Such modifications, however, cannot destroy the fundamental characteristics of the basic design reference.

The necktie of Maletsky has design characteristics that are basically the same as the claimed design: It has an overall triangular shape with the left and right sides that come to a point at the bottom center of the garment. The top edge curves downward and the left and right sides narrow toward the top to form straps. The claimed design differs from Maletsky in that the straps on Maletsky have a buckle on the left strap and a clasp on the right strap and the straps are more squared off at the ends while the claimed design has straps that have no fasteners and the straps are round at the ends. Gazaway shows a bandana without buckles or clasps with straps that are round at the ends. A de minimis difference between the claimed design and the prior art is that the claimed design has stitching all along the edges and a small rectangular stitched feature on the right front side near the point. This minor difference does not create a patentably distinct design. See MPEP 1504.03(B). See examples below.

Application/Control Number: 29/740,838
Art Unit: 2925

Page 7

Conclusion

The claim stands twice rejected under 35 U.S.C. § 103.

Contact

Any inquiry concerning this communication or earlier communications from the examiner should be directed to ELIZABETH ANNE GLASSBERG whose telephone number is (571)272-9934. The examiner can normally be reached Monday-Friday 9am-5pm EST. Examiner interviews are available via telephone, in-person, and video conferencing using a USPTO supplied web-based collaboration tool. To schedule an interview, applicant is encouraged to use the USPTO Automated Interview Request (AIR) at <http://www.uspto.gov/interviewpractice>. If attempts to reach the examiner by telephone are unsuccessful, the examiner's supervisor, Dana K WEILAND can be reached on (571)270-0253. The fax phone number for the organization where this application or proceeding is assigned is 571-273-8300.

Information regarding the status of published or unpublished applications may be obtained from Patent Center. Unpublished application information in Patent Center is available to registered users. To file and manage patent submissions in Patent Center, visit: <https://patentcenter.uspto.gov>. Visit <https://www.uspto.gov/patents/apply/patent-center> for more information about Patent Center and <https://www.uspto.gov/patents/docx> for information about filing in DOCX format. For additional questions, contact the Electronic Business Center (EBC) at 866-217-9197 (toll-free). If you would like assistance from a USPTO Customer Service Representative, call 800-786-9199 (IN USA OR CANADA) or 571-272-1000.

/E.A.G./
Examiner, Art Unit 2925

/VY N KOENIG/
Supervisory Patent Examiner, Art Unit 2923

Exhibit

6

IN THE UNITED STATES PATENT AND TRADEMARK OFFICE

In re application of

Andrew Isom

Application No. 29/740,838

Filed: July 7, 2020

For: **BANDANA FOR AN ANIMAL**

Group Art Unit: 2925

Confirmation No. 2459

Examiner: GLASSBERG, ELIZABETH ANNE

RESPONSE TO NON-FINAL OFFICE ACTION

TO THE COMMISSIONER FOR PATENTS:

The following remarks are filed in response to the Office Action mailed November 8, 2022.

U.S. Patent Application No. 29/740,838

REMARKS

This response is filed in response to the Office Action mailed November 8, 2022.

For at least the reasons presented below, Applicant respectfully submits that the pending claim, with the submitted drawings, is in condition for allowance.

Examiner's Comments

As previously noted, the previous rejections lacked adequate support as being based solely on a dynamic website that were aligned with a purported date without any evidence that the two were actually correlated. Further, the Declaration stating the relevant facts as to the cited dynamic website is considered to be entirely sufficient to overcome the inadequately supported rejection.

35 U.S.C. § 103 Rejection

The claim is rejected as allegedly being unpatentable over U.S. Patent D515250 to Story on 02/14/2006 in view of U.S. Patent D631208 to Gazaway on 01/18/2011.

In determining patentability of a design, it is the overall appearance, the visual effect of the design as a whole, which must be taken into consideration. *In re Rosen*, 673 F.2d 388, 390 (C.C.P.A. 1982). *See also In re Yardley*, 493 F.2d 1389, 1392-1393 (C.C.P.A. 1974) (“[the] basic consideration in determining the patentability of designs over the prior art is similarity of appearance”). “Therefore, in order to support a holding of obviousness, a primary reference must be more than a design concept; it must have an appearance substantially the same as the claimed design.” M.P.E.P. § 1504.03 (citing *In re Harvey*, 12 F.3d 1061 (Fed. Cir. 1993)).

I. THE OFFICE ACTION IMPROPERLY DISREGARDS THE EXPRESSLY CLAIMED STITCHING

As previously asserted, the distinctive stitching of the bandana is considered part of the patentable design. Despite this express claim, the Office Action acknowledges the references of record failure to disclose such stitching and erroneously alleges that the stitching may simply be disregarded. This assertion is entirely misplaced.

U.S. Patent Application No. 29/740,838

From a review of the drawings, the stitching is an integral part and prominent feature of the design that adds to the distinct appearance of the overall claimed bandana design. Further, in addition to the border stitching encompassing the entirety of the bandana, the bandana design further includes distinctive rectangular stitching extending inward from the border stitching in a further distinctive manner.

Accordingly, the assertion in the Office Action that the stitching is de minimis or inconsequential is entirely unsupported. Rather, looking at the figures themselves, it is clear that the stitching is at least one of the more distinctive and prominent portions of the design of the bandana.

Thus, as it is clear that the cited references are not substantially the same as the claimed design, the rejection should be withdrawn.

II. NEITHER STORY NOR GAZAWAY DISCLOSES THE ASYMMETRIC SHAPE OF THE BANDANA

As best shown in FIG. 2, the claimed design of the bandana exhibits an overall side-to-side asymmetric appearance with the curvature of the upper edge being offset relative to the lower point of the bottom edge of the bandana. The references of record entirely fail to disclose such a distinctive shape of the bandana design.

While one side of Story's tie appears to be longer than the other, there is no indication that the upper curvature is offset relative to the bottom point. That is, the central portion of Story's horse bandana appears to be symmetrical. Further, Gazaway's design also appears to be entirely symmetrical.

Thus, as it is clear that the cited references are not substantially the same as the claimed design, the rejection should be withdrawn for this additional reason.

III. NEITHER STORY NOR GAZAWAY DISCLOSES THE OVERALL SHAPE OF THE BANDANA

Finally, the offset or asymmetrical upper curvature of the instant design blends into two rounded ends that are angled upward. Both Story and Gazaway further fail to disclose such a design and are both clearly not substantially the same as the claimed design.

U.S. Patent Application No. 29/740,838

Further, the arms of Story's horse bandana are clearly two or more times longer and exhibit an entirely different appearance than that of the instant claimed design of the Bandana that includes relatively shorter, thicker arms that angle upward and terminate in the rounded ends.

Thus, the rejection should be withdrawn for this yet additional reason.

U.S. Patent Application No. 29/740,838

Conclusion

In view of the foregoing, Applicant believes that the application is in condition for allowance. The issuance of a formal Notice of Allowance at an early date is respectfully requested.

If the Examiner believes a telephone conference would expedite prosecution of this application, please contact the undersigned at (801) 935-4935.

Respectfully submitted,

By: /Gregory C. Baker/
Gregory C. Baker
Registration No. 61,335
PCFB LLC
4001 South 700 East, Suite 500
Salt Lake City, UT 84017
Telephone: (801) 935-4935
Facsimile: (801) 935-4936

Exhibit

7



UNITED STATES DEPARTMENT OF COMMERCE
 United States Patent and Trademark Office
 Address: COMMISSIONER FOR PATENTS
 P.O. Box 1450
 Alexandria, Virginia 22313-1450
 www.uspto.gov

APPLICATION NO.	FILING DATE	FIRST NAMED INVENTOR	ATTORNEY DOCKET NO.	CONFIRMATION NO.
29/740,838	07/07/2020	Andrew Isom	RR.1000US	2459
102983 PCFB 4001 South 700 East, Suite 500 Salt Lake City, UT 84107	7590 03/28/2023		EXAMINER GLASSBERG, ELIZABETH ANNE	
			ART UNIT 2925	PAPER NUMBER
			NOTIFICATION DATE 03/28/2023	DELIVERY MODE ELECTRONIC

Please find below and/or attached an Office communication concerning this application or proceeding.

The time period for reply, if any, is set in the attached communication.

Notice of the Office communication was sent electronically on above-indicated "Notification Date" to the following e-mail address(es):

april@pcfblaw.com
 greg@pcfblaw.com
 jared@pcfblaw.com

Application/Control Number: 29/740,838
Art Unit: 2925

Page 2

FINAL REJECTION

The present application, filed on or after March 16, 2013, is being examined under the first inventor to file provisions of the AIA.

Examiner's Comment

The merits of this case have been carefully examined anew in light of applicant's response received 02/06/2023. The two rejections under 35 U.S.C. § 103 have been carefully considered in view of Applicant's arguments and have not been overcome and have been made final.

Rejection – 35 U.S.C. § 103

The claim is AGAIN AND FINALLY REJECTED under 35 U.S.C. § 103 as being unpatentable over U.S. patent number D515250 to Story on 02/14/2006; in view of U.S. patent number D631208 to Gazaway on 01/18/2011.

Although the invention is not identically disclosed or described as set forth in 35 U.S.C. § 102, if the differences between the claimed invention and the prior art are such that the claimed invention as a whole would have been obvious before the effective filing date of the claimed invention to a designer having ordinary skill in the art to which the claimed invention pertains, the invention is not patentable.

In a proper rejection of a design claim under 35 U.S.C. § 103, there must be a reference (the basic design), a something in existence, the design characteristics of which are basically the same as the claimed design in order to support a holding of obviousness. In other words, the basic reference design must look something like the claimed design. *In re Harvey*, 12 F.3d 1061, 1063, 29 USPQ 1206, 1208 (Fed. Cir. 1993) and *In re Rosen*, 673 F.2d 388, 391, 213 USPQ 347, 350 (CCPA 1982). Once such a design has been established, features thereof may reasonably be interchanged with or added from those in other pertinent references to achieve the claimed design. Such modifications, however, cannot destroy the fundamental characteristics of the basic design reference.

The bandana of Story has design characteristics that are basically the same as the claimed design: It has an overall triangular shape with the left and right sides that are straight come to a 90 degree point at the bottom center of the garment. The top edge curves downward and the left and right sides narrow toward the top to form straps. The claimed design differs from Story in

Application/Control Number: 29/740,838
 Art Unit: 2925

Page 3

that the straps on Story are narrower in proportion to the rest of the body, not of the same length, and ends of the straps have an angled squared off edge; while the claimed design has straps that are wider in proportion to the rest of the body, they are of equal length, and are round at the ends. Gazaway shows a bandana with straps that are wider in proportion to the rest of the body, of equal length, and are round at the ends. A de minimis difference between the claimed design and the prior art is that the claimed design has stitching all along the edges and a small rectangular stitched feature on the right front side near the point. This minor difference does not create a patentably distinct design. See MPEP 1504.03(B). See examples below.

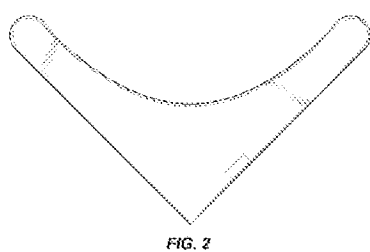

FIG. 2
 Claimed Design 7/7/2020

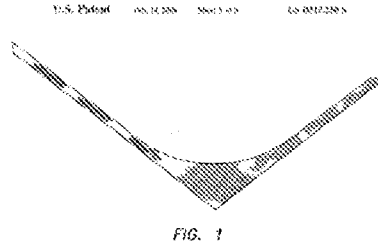

FIG. 1
 Story 02/14/2006

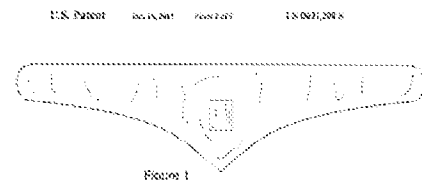

Figure 1
 Gazaway 01/18/2011

It would have been obvious to one of ordinary skill in the art at the time the invention was made to modify the bandana of Story by making it with wider straps of equal length that have round ends as taught by Gazaway.

The claimed design would have no patentable distinction over the Examiner's combination of references. Obviousness, like anticipation, requires courts to consider the perspective of the ordinary observer. Comparing the claimed design with the Examiner's combination of references takes into account significant differences between the two designs, not minor or trivial differences that necessarily exist between any two designs that are not exact copies of one another. Just as "minor differences between a patented design and an accused article's design cannot, and shall not, prevent a finding of infringement," (*Litton*, 728 F.2d at 1444), so too minor differences cannot prevent a finding of anticipation. (*International Seaway Trading Corp. v. Walgreens Corp.*, 93 USPQ2d 1001 (Fed. Cir. 2009).)

This modification of the primary reference in light of the secondary reference is proper because the applied references are so related that the appearance of features shown in one would suggest the application of those features to the other. See *In re Rosen*, 673 F.2d 388, 213 USPQ 347 (CCPA 1982); *In re Carter*, 673 F.2d 1378, 213 USPQ 625 (CCPA 1982), and *In re Glavas*, 230

Application/Control Number: 29/740,838
Art Unit: 2925

Page 4

F.2d 447, 109 USPQ50 (CCPA 1956). Further, it is noted that case law has held that one skilled in the art is charged with knowledge of the related art; therefore, the combination of old elements, herein, would have been well within the level of ordinary skill. See *In re Antle*, 444 F.2d 1168, 170 USPQ285 (CCPA 1961) and *In re Nalbandian*, 661 F.2d 1214, 211 USPQ782 (CCPA 1982).

Rejection – 35 U.S.C. § 103

The claim is AGAIN AND FINALLY REJECTED under 35 U.S.C. § 103 as being unpatentable over U.S. patent number D309212 to Maletsky, et al on 07/17/1990; in view of U.S. patent number D631208 to Gazaway on 01/18/2011.

Although the invention is not identically disclosed or described as set forth in 35 U.S.C. § 102, if the differences between the claimed invention and the prior art are such that the claimed invention as a whole would have been obvious before the effective filing date of the claimed invention to a designer having ordinary skill in the art to which the claimed invention pertains, the invention is not patentable.

In a proper rejection of a design claim under 35 U.S.C. § 103, there must be a reference (the basic design), a something in existence, the design characteristics of which are basically the same as the claimed design in order to support a holding of obviousness. In other words, the basic reference design must look something like the claimed design. In *re Harvey*, 12 F.3d 1061, 1063, 29 USPQ1206, 1208 (Fed. Cir. 1993) and *In re Rosen*, 673 F.2d 388, 391, 213 USPQ347, 350 (CCPA 1982). Once such a design has been established, features thereof may reasonably be interchanged with or added from those in other pertinent references to achieve the claimed design. Such modifications, however, cannot destroy the fundamental characteristics of the basic design reference.

The necktie of Maletsky has design characteristics that are basically the same as the claimed design: It has an overall triangular shape with the left and right sides that come to a point at the bottom center of the garment. The top edge curves downward and the left and right sides narrow toward the top to form straps. The claimed design differs from Maletsky in that the straps on Maletsky have a buckle on the left strap and a clasp on the right strap and the straps are more squared off at the ends while the claimed design has straps that have no fasteners and the straps are round at the ends. Gazaway shows a bandana without buckles or clasps with straps that are

Application/Control Number: 29/740,838
 Art Unit: 2925

Page 5

round at the ends. A de minimis difference between the claimed design and the prior art is that the claimed design has stitching all along the edges and a small rectangular stitched feature on the right front side near the point. This minor difference does not create a patentably distinct design. See MPEP 1504.03(B). See examples below.

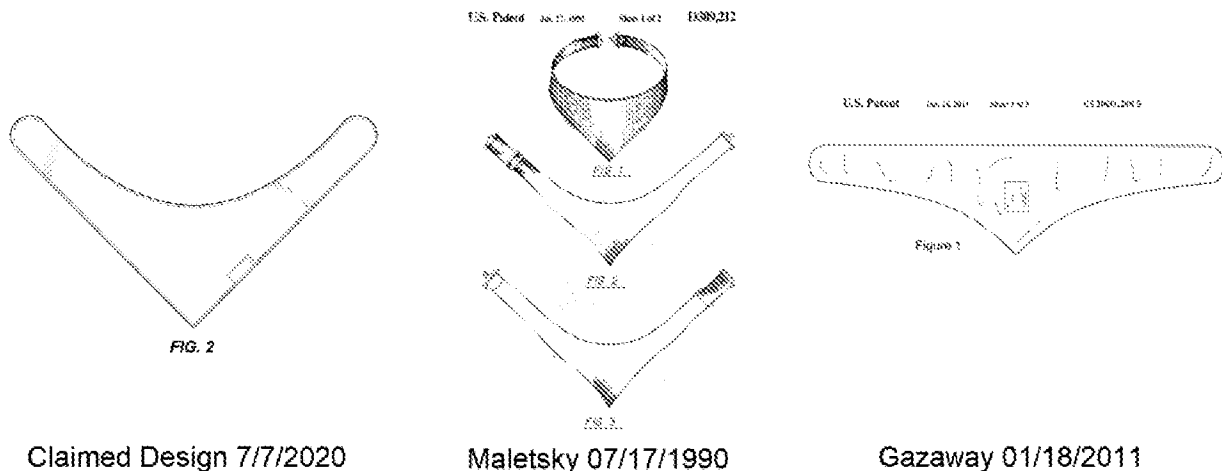

It would have been obvious to one of ordinary skill in the art at the time the invention was made to modify the necktie of Maletsky by making it without fasteners and with straps that have round ends as taught by Gazaway.

The claimed design would have no patentable distinction over the Examiner's combination of references. Obviousness, like anticipation, requires courts to consider the perspective of the ordinary observer. Comparing the claimed design with the Examiner's combination of references takes into account significant differences between the two designs, not minor or trivial differences that necessarily exist between any two designs that are not exact copies of one another. Just as "minor differences between a patented design and an accused article's design cannot, and shall not, prevent a finding of infringement," (*Litton*, 728 F.2d at 1444), so too minor differences cannot prevent a finding of anticipation. (*International Seaway Trading Corp. v. Walgreens Corp.*, 93 USPQ2d 1001 (Fed. Cir. 2009).)

This modification of the primary reference in light of the secondary reference is proper because the applied references are so related that the appearance of features shown in one would suggest the application of those features to the other. See *In re Rosen*, 673 F.2d 388, 213 USPQ 347 (CCPA 1982); *In re Carter*, 673 F.2d 1378, 213 USPQ 625 (CCPA 1982), and *In re Glavas*, 230 F.2d 447, 109 USPQ 50 (CCPA 1956). Further, it is noted that case law has held that one skilled

Application/Control Number: 29/740,838
 Art Unit: 2925

Page 6

in the art is charged with knowledge of the related art; therefore, the combination of old elements, herein, would have been well within the level of ordinary skill. See *In re Antle*, 444 F.2d 1168, 170 USPQ 285 (CCPA 1961) and *In re Nalbandian*, 661 F.2d 1214, 211 USPQ 782 (CCPA 1982).

Examiner Response to Applicant Arguments

The applicant argues that [*From a review of the drawings, the stitching is an integral part and prominent feature of the design that adds to the distinct appearance of the overall claimed bandana design.*] The examiner disagrees. Adding topstitching is not novel, it would have been obvious to someone skilled in the art to apply topstitching to the bandana.

The applicant argues that [*As best shown in FIG. 2, the claimed design of the bandana exhibits an overall side-to-side asymmetric appearance with the curvature of the upper edge being offset relative to the lower point of the bottom edge of the bandana. The references of record entirely fail to disclose such a distinctive shape of the bandana design.*] The examiner disagrees. The drawing of FIG. 2 shows a bandana that is symmetrical, if you duplicate FIG. 2 then flip the image and overlay the flipped image on top of the original image, the edges line up perfectly. If the bandana was asymmetrical, as the applicant states, then the flipped image would not align with the original when overlaid. See examples below.

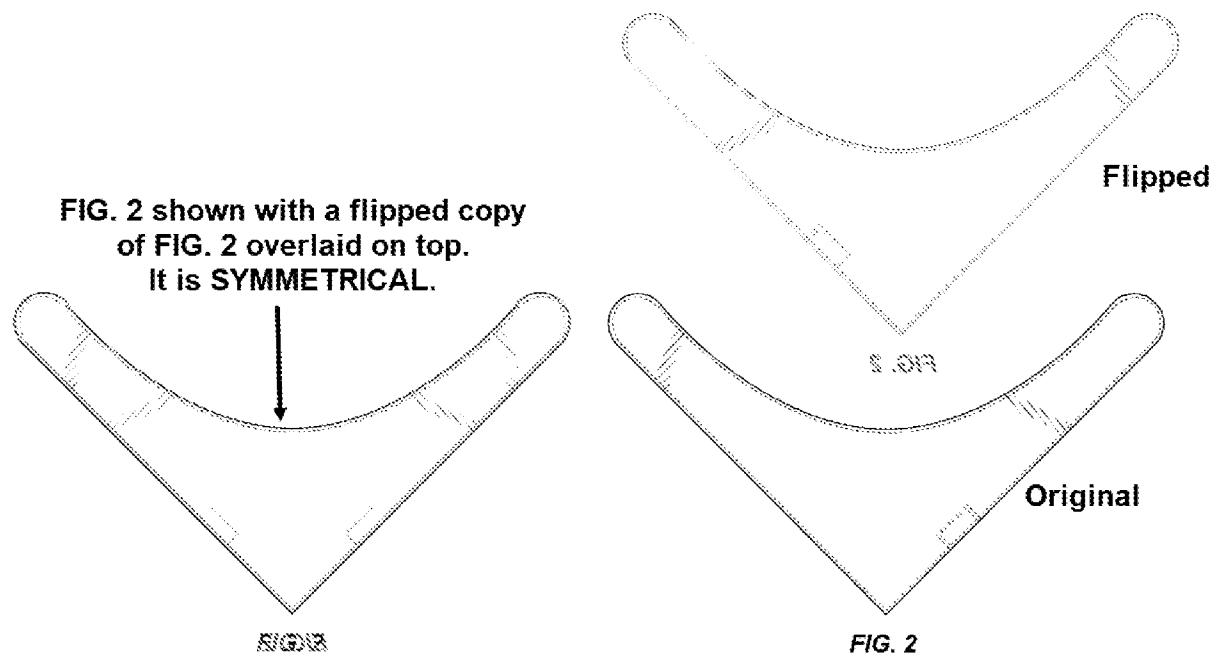

Application/Control Number: 29/740,838
Art Unit: 2925

Page 7

The applicant argues that [*Finally, the offset or asymmetrical upper curvature of the instant design blends into two rounded ends that are angled upward. Both Story and Gazaway further fail to disclose such a design and are both clearly not substantially the same as the claimed design.*] The examiner disagrees. The ends of the Story bandana are angled upward and the ends of Gazaway are rounded; therefore it would have been obvious to one of ordinary skill in the art at the time the invention was made to modify the bandana of Story by making it with wider straps of equal length that have round ends as taught by Gazaway.

The applicant argues that [*the arms of Story's horse bandana are clearly two or more times longer and exhibit an entirely different appearance than that of the instant claimed design of the Bandana that includes relatively shorter, thicker arms that angle upward and terminate in the rounded ends.*] Story has an overall triangular shape with the left and right sides that are straight come to a 90 degree point at the bottom center of the garment. The top edge curves downward and the left and right sides narrow toward the top to form straps. As stated in the previous office action, and above:

“In a proper rejection of a design claim under 35 U.S.C. § 103, there must be a reference (the basic design), a something in existence, the design characteristics of which are basically the same as the claimed design in order to support a holding of obviousness. In other words, the basic reference design must look something like the claimed design.”

This clearly establishes that the primary reference does not need to be identical to the claimed design, but rather have design characteristics that are basically the same as the claimed design; and once established, features of other pertinent references may be reasonably interchanged with/or added to the primary reference to achieve the claimed design.

Conclusion

The claim stands FINALLY twice rejected under 35 U.S.C. § 103.

THIS ACTION IS MADE FINAL. See MPEP § 706.07(a). Applicant is reminded of the extension of time policy as set forth in 37 CFR 1.136(a).

A shortened statutory period for reply to this final action is set to expire THREE MONTHS from the mailing date of this action. In the event a first reply is filed within TWO MONTHS of the

Application/Control Number: 29/740,838
Art Unit: 2925

Page 8

mailing date of this final action and the advisory action is not mailed until after the end of the THREE-MONTH shortened statutory period, then the shortened statutory period will expire on the date the advisory action is mailed, and any extension fee pursuant to 37 CFR 1.136(a) will be calculated from the mailing date of the advisory action. In no event, however, will the statutory period for reply expire later than SIX MONTHS from the mailing date of this final action.

Contact

Any inquiry concerning this communication or earlier communications from the examiner should be directed to ELIZABETH ANNE GLASSBERG whose telephone number is (571)272-9934. The examiner can normally be reached Monday-Friday 9am-5pm EST. Examiner interviews are available via telephone, in-person, and video conferencing using a USPTO supplied web-based collaboration tool. To schedule an interview, applicant is encouraged to use the USPTO Automated Interview Request (AIR) at <http://www.uspto.gov/interviewpractice>. If attempts to reach the examiner by telephone are unsuccessful, the examiner's supervisor, Dana KWEILAND can be reached on (571)270-0253. The fax phone number for the organization where this application or proceeding is assigned is 571-273-8300.

Information regarding the status of published or unpublished applications may be obtained from Patent Center. Unpublished application information in Patent Center is available to registered users. To file and manage patent submissions in Patent Center, visit: <https://patentcenter.uspto.gov>. Visit <https://www.uspto.gov/patents/apply/patent-center> for more information about Patent Center and <https://www.uspto.gov/patents/docx> for information about filing in DOCX format. For additional questions, contact the Electronic Business Center (EBC) at 866-217-9197 (toll-free). If you would like assistance from a USPTO Customer Service Representative, call 800-786-9199 (IN USA OR CANADA) or 571-272-1000.

/E.A.G./
Examiner, Art Unit 2925

/VY N KOENIG/
Supervisory Patent Examiner, Art Unit 2918

Exhibit

8

Doc Code: AP.PRE.REQ

Document Description: Pre-Appeal Brief Conference Request

PTO/AIA/33 (09-22)

Approved for use through 05/31/2024. OMB 0651-0031
U.S. Patent and Trademark Office; U.S. DEPARTMENT OF COMMERCE

Under the Paperwork Reduction Act of 1995, no persons are required to respond to a collection of information unless it displays a valid OMB control number.

PRE-APPEAL BRIEF REQUEST FOR REVIEW	Docket Number (Optional) RR.1000US	
I hereby certify that this correspondence is being facsimile transmitted to the USPTO, transmitted via the USPTO's patent electronic filing system, or deposited with the United States Postal Service with sufficient postage as first class mail in an envelope addressed to "Commissioner for Patents, P.O. Box 1450, Alexandria, VA 22313-1450" [37 CFR 1.8(a)] on June 26, 2023 Signature <u>/GCB/</u> Typed or printed name <u>Gregory C. Baker</u>	Application Number 29/740,838	Filed July 7, 2020
	First Named Inventor Andrew Isom	
	Art Unit 2925	Examiner GLASSBERG, ELIZABETH

Applicant requests review of the final rejection in the above-identified application. No amendments are being filed with this request.

This request is being filed with a notice of appeal.

The review is requested for the reason(s) stated on the attached sheet(s).

Note: No more than five (5) pages may be provided.

I am the	<u>/GCB/</u>
<input type="checkbox"/> applicant.	_____ Signature
<input checked="" type="checkbox"/> attorney or agent of record. Registration number <u>61335</u>	<u>Gregory C. Baker</u> Typed or printed name
<input type="checkbox"/> attorney or agent acting under 37 CFR 1.34. Registration number if acting under 37 CFR 1.34 _____	<u>801-935-4935</u> Telephone number
	<u>June 26, 2023</u> Date

NOTE: This form must be signed in accordance with 37 CFR 1.33. See 37 CFR 1.4 for signature requirements and certifications. Submit multiple forms if more than one signature is required, see below*.

*Total of 1 forms are submitted.

A Federal agency may not conduct or sponsor, and a person is not required to respond to, nor shall a person be subject to a penalty for failure to comply with an information collection subject to the requirements of the Paperwork Reduction Act of 1995, unless the information collection has a currently valid OMB Control Number. The OMB Control Number for this information collection is 0651-0031. Public burden for this form is estimated to average 12 minutes per response, including the time for reviewing instructions, searching existing data sources, gathering and maintaining the data needed, and completing and reviewing the information collection. Send comments regarding this burden estimate or any other aspect of this information collection, including suggestions for reducing this burden to the Chief Administrative Officer, United States Patent and Trademark Office, P.O. Box 1450, Alexandria, VA 22313-1450 or email InformationCollection@uspto.gov. DO NOT SEND FEES OR COMPLETED FORMS TO THIS ADDRESS. SEND TO: Mail Stop AF, Commissioner for Patents, P.O. Box 1450, Alexandria, VA 22313-1450.

If you need assistance in completing the form, call 1-800-PTO-9199 and select option 2.

Privacy Act Statement

The Privacy Act of 1974 (P.L. 93-579) requires that you be given certain information in connection with your submission of the attached form related to a patent application or patent. The United States Patent and Trademark Office (USPTO) collects the information in this record under authority of 35 U.S.C. 2. The USPTO's system of records is used to manage all applicant and owner information including name, citizenship, residence, post office address, and other information with respect to inventors and their legal representatives pertaining to the applicant's/owner's activities in connection with the invention for which a patent is sought or has been granted. The applicable Privacy Act System of Records Notice for the information collected in this form is COMMERCE/PAT-TM-7 Patent Application Files, available in the Federal Register at 78 FR 19243 (March 29, 2013). <https://www.govinfo.gov/content/pkg/FR-2013-03-29/pdf/2013-07341.pdf>

Routine uses of the information in this record may include disclosure to: 1) law enforcement, in the event that the system of records indicates a violation or potential violation of law; 2) a Federal, state, local, or international agency, in response to its request; 3) a contractor of the USPTO having need for the information in order to perform a contract; 4) the Department of Justice for determination of whether the Freedom of Information Act (FOIA) requires disclosure of the record; 5) a Member of Congress submitting a request involving an individual to whom the record pertains, when the individual has requested the Member's assistance with respect to the subject matter of the record; 6) a court, magistrate, or administrative tribunal, in the course of presenting evidence, including disclosures to opposing counsel in the course of settlement negotiations; 7) the Administrator, General Services Administration (GSA), or their designee, during an inspection of records conducted by GSA under authority of 44 U.S.C. 2904 and 2906, in accordance with the GSA regulations and any other relevant (i.e., GSA or Commerce) directive, where such disclosure shall not be used to make determinations about individuals; 8) another federal agency for purposes of National Security review (35 U.S.C. 181) and for review pursuant to the Atomic Energy Act (42 U.S.C. 218(c)); 9) the Office of Personnel Management (OPM) for personnel research purposes; and 9) the Office of Management and Budget (OMB) for legislative coordination and clearance.

If you do not furnish the information requested on this form, the USPTO may not be able to process and/or examine your submission, which may result in termination of proceedings, abandonment of the application, and/or expiration of the patent.

Additional Uses

Additional USPTO uses of the information in this record may include disclosure to: 1) the International Bureau of the World Intellectual Property Organization, if the record is related to an international application filed under the Patent Cooperation Treaty; 2) the public i) after publication of the application pursuant to 35 U.S.C. 122(b), ii) after issuance of a patent pursuant to 35 U.S.C. 151, iii) if the record was filed in an application which became abandoned or in which the proceedings were terminated and which application is referenced by either a published application, an application open to public inspections, or an issued patent, or iv) without publication of the application or patent under the specific circumstances provided for by 37 CFR 1.14(a)(1)(v)-(vii); and/or 3) the National Archives and Records Administration, for inspection of records.

PATENT

IN THE UNITED STATES PATENT AND TRADEMARK OFFICE

In re Application of:

Andrew Isom

Serial No.: 29/740,838

Filed: July 7, 2020

For: BANDANA FOR AN ANIMAL

Confirmation No.: 2459

Examiner: GLASSBERG, ELIZABETH
ANNE

Group Art Unit: 2925

Attorney Docket No.: RR.1000US

VIA ELECTRONIC FILING

PRE-APPEAL BRIEF

As set below the rejections in the Final Office Action (FOA) is in error for failing to present a prima facie case of obviousness and should be reversed.

35 U.S.C. § 103 Rejection

In determining patentability of a design, it is the overall appearance, the visual effect of the design as a whole, which must be taken into consideration. *In re Rosen*, 673 F.2d 388, 390 (C.C.P.A. 1982). *See also In re Yardley*, 493 F.2d 1389, 1392-1393 (C.C.P.A. 1974) (“[the] basic consideration in determining the patentability of designs over the prior art is similarity of appearance”). “Therefore, in order to support a holding of obviousness, a primary reference must be more than a design concept; it must have an appearance substantially the same as the claimed design.” M.P.E.P. § 1504.03 (*citing In re Harvey*, 12 F.3d 1061 (Fed. Cir. 1993)).

Rejection #1 - U.S. Patent D515250 to Story with U.S. Patent D631208 to Gazaway

I. THE FOA IMPROPERLY DISREGARDS THE EXPRESSLY CLAIMED STITCHING

As previously asserted, **the distinctive stitching of the bandana is part of the patentable design**. Despite this express claim, the FOA acknowledges the references of record failure to disclose such stitching and erroneously alleges that the stitching may simply be disregarded. This assertion is entirely misplaced.

From a review of the drawings, the stitching is an integral part and prominent feature of the design that adds to the distinct appearance of the overall claimed bandana design. Further, in addition to the border stitching encompassing the entirety of the bandana, the bandana design further includes distinctive rectangular stitching extending inward from the border stitching in a further distinctive manner.

Accordingly, the assertion in the FOA that the stitching is de minimis or inconsequential is entirely unsupported. Rather, looking at the figures themselves, it is clear that the stitching is at least one of the more distinctive and prominent portions of the design of the bandana.

In a different portion of the FOA, it is asserted that added stitching would be obvious. However, the FOA is in error as not providing anything but a conclusory statement regarding the

addition of stitching. Further, there is no supplied reasoning regarding such an addition that would match the appearance shown in the claimed design.

Thus, as it is clear that the cited references are not substantially the same as the claimed design, the rejection is in error and should be withdrawn.

II. NEITHER STORY NOR GAZAWAY DISCLOSES THE ASYMMETRIC STITCHING OF THE BANDANA

As best shown in FIG. 2, the claimed design of the bandana exhibits an asymmetric appearance due to the additional stitching on one side of the bandana. The references of record entirely fail to disclose such a distinctive shape of the bandana design.

Thus, as it is clear that the cited references are not substantially the same as the claimed design, the rejection should be withdrawn for this additional reason.

III. NEITHER STORY NOR GAZAWAY DISCLOSES THE OVERALL SHAPE OF THE BANDANA

The upper curvature of the instant design blends into two arms with rounded ends **that are angled upward**. Both Story and Gazaway further fail to disclose such a design and are both clearly not substantially the same as the claimed design.

Further, the arms of Story's horse bandana are clearly two or more times longer and exhibit an entirely different appearance than that of the instant claimed design of the Bandana that includes relatively shorter, thicker arms that angle upward and terminate in the rounded ends.

Further still, the straps of Story are not just narrower and squared-off, they are also not designed to be tied when secured to the horse (*see* FIG. 3 of Story), which effects the overall appearance of Story. In particular, it appears that the straps of Story provide some type of overlapping strap that is not tied. The clean lines of the overlapping straps when worn by a horse have a very different visual aesthetic. Further, adding the rounded ends of Gazaway would not change this appearance as the rounded ends would simply overlap.

Finally, as shown in FIG. 8 of the claimed design, part of the claimed design involves the look of the Bandana as tied including the stitching. As above, Story does not have such a tied

appearance. Further, there appears to be no reason to add a tied appearance from Gazaway as this does not fit with the overall design of Story's horse bandana (*see* FIG. 3 of Story).

Thus, the rejection should be withdrawn for this yet additional reason.

Rejection #2 - U.S. Patent D309212 to Maletsky with Gazaway

I. THE FOA IMPROPERLY DISREGARDS THE EXPRESSLY CLAIMED STITCHING

As above, **the distinctive stitching of the bandana is considered part of the patentable design**. For the same reasons set forth above, this rejection is in clear error for disregarding the stitching as either being improperly construed by the Examiner as de minimis or inconsequential or for the lack of any valid reasoning on why the stitching would have been obvious to add in the appearance shown in the claimed design.

Thus, as it is clear that the cited references are not substantially the same as the claimed design, the rejection is in error and should be withdrawn.

II. NEITHER MALETSKY NOR GAZAWAY DISCLOSES THE ASYMMETRIC STITCHING OF THE BANDANA

As above, the claimed design of the bandana exhibits an asymmetric appearance due to the additional stitching on one side of the bandana. The references of record entirely fail to disclose such a distinctive shape of the bandana design.

Thus, as it is clear that the cited references are not substantially the same as the claimed design, the rejection should be withdrawn for this additional reason.

III. NEITHER MALETSKY NOR GAZAWAY DISCLOSES THE OVERALL SHAPE OF THE BANDANA

The upper curvature of the instant design blends into arm with two rounded ends **that are angled upward**. Both Maletsky and Gazaway further fail to disclose such a design and are both clearly not substantially the same as the claimed design.

Similar to Story, the arms of Maletsky's bandana are clearly longer and exhibit an entirely different appearance than that of the instant claimed design of the Bandana that includes relatively shorter, thicker arms that angle upward and terminate in the rounded ends.

Further still, the straps of Maletsky are not just narrower and squared-off, they are also not designed to be tied when secured, which effects the overall appearance of Maletsky. The clean lines of the clasped straps have a very different visual aesthetic (*see* FIG. 1 of Maletsky). Further, adding the rounded ends of Gazaway would not change this appearance as the rounded ends would still include the clasps.

Finally, as shown in FIG. 8, part of the claimed design involves the look of the bandana as tied including the stitching. As above, Maletsky does not have such a tied appearance. Further, there appears to be no reason to add a tied appearance from Gazaway as this does not fit with the overall design of Maletsky's clasped necktie (*see* FIG. 1 of Maletsky).

In particular, the straps of Maletsky's necktie include a clasp and are not designed to be tied when worn. Neckties are designed to be worn around the collar of a dress shirt. The clasp of Maletsky's necktie appears to be designed to be located at the back of a dress-shirt collar. It would change the fundamental characteristics of the design of Maletsky to replace the straps and clasp. Further, it would appear to ruin the overall design of Maletsky as tied straps of a necktie at the back of a dress-shirt collar would create an entirely different design. Additionally, replacing the straps of Maletsky's necktie with the wider straps of Gazaway would cause the straps to extend beyond the collar when worn.

Thus, the rejection should be withdrawn for this yet additional reason.

For the reasons set forth above, the rejections should be reversed.

Respectfully submitted,
/Gregory C. Baker/
Gregory C. Baker
Registration No. 61,335
Attorney for Applicant
PCFB LLC
4001 South 700 East, Suite 500
Salt Lake City, Utah 84107
Telephone: 801-935-4935

Date: June 26, 2023

Exhibit

9



UNITED STATES PATENT AND TRADEMARK OFFICE

UNITED STATES DEPARTMENT OF COMMERCE
 United States Patent and Trademark Office
 Address: COMMISSIONER FOR PATENTS
 P.O. Box 1450
 Alexandria, Virginia 22313-1450
 www.uspto.gov

NOTICE OF ALLOWANCE AND FEE(S) DUE

102983 7590 08/16/2023
 PCFB
 4001 South 700 East, Suite 500
 Salt Lake City, UT 84107

EXAMINER	
GLASSBERG, ELIZABETH ANNE	
ART UNIT	PAPER NUMBER
2925	

DATE MAILED: 08/16/2023

APPLICATION NO.	FILING DATE	FIRST NAMED INVENTOR	ATTORNEY DOCKET NO.	CONFIRMATION NO.
29/740,838	07/07/2020	Andrew Isom	RR.1000US	2459

TITLE OF INVENTION: BANDANA FOR AN ANIMAL

APPLN. TYPE	ENTITY STATUS	ISSUE FEE DUE	PUBLICATION FEE DUE	PREV. PAID ISSUE FEE	TOTAL FEE(S) DUE	DATE DUE
nonprovisional	SMALL	\$296	\$0.00	\$0.00	\$296	11/16/2023

THE APPLICATION IDENTIFIED ABOVE HAS BEEN EXAMINED AND IS ALLOWED FOR ISSUANCE AS A PATENT. PROSECUTION ON THE MERITS IS CLOSED. THIS NOTICE OF ALLOWANCE IS NOT A GRANT OF PATENT RIGHTS. THIS APPLICATION IS SUBJECT TO WITHDRAWAL FROM ISSUE AT THE INITIATIVE OF THE OFFICE OR UPON PETITION BY THE APPLICANT. SEE 37 CFR 1.313 AND MPEP 1308.

THE ISSUE FEE AND PUBLICATION FEE (IF REQUIRED) MUST BE PAID WITHIN THREE MONTHS FROM THE MAILING DATE OF THIS NOTICE OR THIS APPLICATION SHALL BE REGARDED AS ABANDONED. THIS STATUTORY PERIOD CANNOT BE EXTENDED. SEE 35 U.S.C. 151. THE ISSUE FEE DUE INDICATED ABOVE DOES NOT REFLECT A CREDIT FOR ANY PREVIOUSLY PAID ISSUE FEE IN THIS APPLICATION. IF AN ISSUE FEE HAS PREVIOUSLY BEEN PAID IN THIS APPLICATION (AS SHOWN ABOVE), THE RETURN OF PART B OF THIS FORM WILL BE CONSIDERED A REQUEST TO REAPPLY THE PREVIOUSLY PAID ISSUE FEE TOWARD THE ISSUE FEE NOW DUE.

HOW TO REPLY TO THIS NOTICE:

I. Review the ENTITY STATUS shown above. If the ENTITY STATUS is shown as SMALL or MICRO, verify whether entitlement to that entity status still applies.

If the ENTITY STATUS is the same as shown above, pay the TOTAL FEE(S) DUE shown above.

If the ENTITY STATUS is changed from that shown above, on PART B - FEE(S) TRANSMITTAL, complete section number 5 titled "Change in Entity Status (from status indicated above)".

For purposes of this notice, small entity fees are 40% the amount of undiscounted fees, and micro entity fees are 20% the amount of undiscounted fees.

II. PART B - FEE(S) TRANSMITTAL, or its equivalent, must be completed and returned to the United States Patent and Trademark Office (USPTO) with your ISSUE FEE and PUBLICATION FEE (if required). If you are charging the fee(s) to your deposit account, section "4b" of Part B - Fee(s) Transmittal should be completed. If an equivalent of Part B is filed, a request to reapply a previously paid issue fee must be clearly made, and delays in processing may occur due to the difficulty in recognizing the paper as an equivalent of Part B.

III. All communications regarding this application must give the application number. Please direct all communications prior to issuance to Mail Stop ISSUE FEE unless advised to the contrary.

IMPORTANT REMINDER: Maintenance fees are due in utility patents issuing on applications filed on or after Dec. 12, 1980. It is patentee's responsibility to ensure timely payment of maintenance fees when due. More information is available at www.uspto.gov/PatentMaintenanceFees.

PART B - FEE(S) TRANSMITTAL

Complete and send this form, together with applicable fee(s), by mail or fax, or via EFS-Web.

By mail, send to: Mail Stop ISSUE FEE
 Commissioner for Patents
 P.O. Box 1450
 Alexandria, Virginia 22313-1450

By fax, send to: (571)-273-2885

INSTRUCTIONS: This form should be used for transmitting the ISSUE FEE and PUBLICATION FEE (if required). Blocks 1 through 5 should be completed where appropriate. All further correspondence will be mailed to the current correspondence address as indicated unless corrected below or directed otherwise in Block 1, by (a) specifying a new correspondence address; and/or (b) indicating a separate "FEE ADDRESS" for maintenance fee notifications. **Because electronic patent issuance may occur shortly after issue fee payment, any desired continuing application should preferably be filed prior to payment of this issue fee in order not to jeopardize copendency.**

CURRENT CORRESPONDENCE ADDRESS (Note: Use Block 1 for any change of address)

Note: A certificate of mailing can only be used for domestic mailings of the Fee(s) Transmittal. This certificate cannot be used for any other accompanying papers. Each additional paper, such as an assignment or formal drawing, must have its own certificate of mailing or transmission.

102983 7590 08/16/2023
 PCFB
 4001 South 700 East, Suite 500
 Salt Lake City, UT 84107

Certificate of Mailing or Transmission

I hereby certify that this Fee(s) Transmittal is being deposited with the United States Postal Service with sufficient postage for first class mail in an envelope addressed to the Mail Stop ISSUE FEE address above, or being transmitted to the USPTO via EFS-Web or by facsimile to (571) 273-2885, on the date below.

(Typed or printed name)
(Signature)
(Date)

APPLICATION NO.	FILING DATE	FIRST NAMED INVENTOR	ATTORNEY DOCKET NO.	CONFIRMATION NO.
-----------------	-------------	----------------------	---------------------	------------------

29/740,838 07/07/2020 Andrew Isom RR.1000US 2459

TITLE OF INVENTION: BANDANA FOR AN ANIMAL

APPLN. TYPE	ENTITY STATUS	ISSUE FEE DUE	PUBLICATION FEE DUE	PREV. PAID ISSUE FEE	TOTAL FEE(S) DUE	DATE DUE
-------------	---------------	---------------	---------------------	----------------------	------------------	----------

nonprovisional SMALL \$296 \$0.00 \$0.00 \$296 11/16/2023

EXAMINER	ART UNIT	CLASS-SUBCLASS
----------	----------	----------------

GLASSBERG, ELIZABETH ANNE 2925 D30-145000

1. Change of correspondence address or indication of "Fee Address" (37 CFR 1.363).

- Change of correspondence address (or Change of Correspondence Address form PTO/AIA/122 or PTO/SB/122) attached.
- "Fee Address" indication (or "Fee Address" Indication form PTO/AIA/47 or PTO/SB/47; Rev 03-02 or more recent) attached. **Use of a Customer Number is required.**

2. For printing on the patent front page, list

- (1) The names of up to 3 registered patent attorneys or agents OR, alternatively, 1 _____
- (2) The name of a single firm (having as a member a registered attorney or agent) and the names of up to 2 registered patent attorneys or agents. If no name is listed, no name will be printed. 2 _____
- 3 _____

3. ASSIGNEE NAME AND RESIDENCE DATA TO BE PRINTED ON THE PATENT (print or type)

PLEASE NOTE: Unless an assignee is identified below, no assignee data will appear on the patent. If an assignee is identified below, the document must have been previously recorded, or filed for recordation, as set forth in 37 CFR 3.11 and 37 CFR 3.81(a). Completion of this form is NOT a substitute for filing an assignment.

(A) NAME OF ASSIGNEE (B) RESIDENCE: (CITY and STATE OR COUNTRY)

Please check the appropriate assignee category or categories (will not be printed on the patent) : Individual Corporation or other private group entity Government

4a. Fees submitted: Issue Fee Publication Fee (if required)

4b. Method of Payment: (Please first reapply any previously paid fee shown above)

- Electronic Payment via Patent Center or EFS-Web Enclosed check Non-electronic payment by credit card (Attach form PTO-2038)
- The Director is hereby authorized to charge the required fee(s), any deficiency, or credit any overpayment to Deposit Account No. _____

5. Change in Entity Status (from status indicated above)

- Applicant certifying micro entity status. See 37 CFR 1.29
- Applicant asserting small entity status. See 37 CFR 1.27
- Applicant changing to regular undiscounted fee status.

NOTE: Absent a valid certification of Micro Entity Status (see forms PTO/SB/15A and 15B), issue fee payment in the micro entity amount will not be accepted at the risk of application abandonment.

NOTE: If the application was previously under micro entity status, checking this box will be taken to be a notification of loss of entitlement to micro entity status.

NOTE: Checking this box will be taken to be a notification of loss of entitlement to small or micro entity status, as applicable.

NOTE: This form must be signed in accordance with 37 CFR 1.31 and 1.33. See 37 CFR 1.4 for signature requirements and certifications.

Authorized Signature _____ Date _____

Typed or printed name _____ Registration No. _____



UNITED STATES PATENT AND TRADEMARK OFFICE

UNITED STATES DEPARTMENT OF COMMERCE
United States Patent and Trademark Office
 Address: COMMISSIONER FOR PATENTS
 P.O. Box 1450
 Alexandria, Virginia 22313-1450
 www.uspto.gov

APPLICATION NO.	FILING DATE	FIRST NAMED INVENTOR	ATTORNEY DOCKET NO.	CONFIRMATION NO.
29/740,838	07/07/2020	Andrew Isom	RR.1000US	2459
102983	7590	08/16/2023	EXAMINER	
PCFB 4001 South 700 East, Suite 500 Salt Lake City, UT 84107			GLASSBERG, ELIZABETH ANNE	
			ART UNIT	PAPER NUMBER
			2925	
DATE MAILED: 08/16/2023				

Determination of Patent Term Adjustment under 35 U.S.C. 154 (b)
 (Applications filed on or after May 29, 2000)

The Office has discontinued providing a Patent Term Adjustment (PTA) calculation with the Notice of Allowance.

Section 1(h)(2) of the AIA Technical Corrections Act amended 35 U.S.C. 154(b)(3)(B)(i) to eliminate the requirement that the Office provide a patent term adjustment determination with the notice of allowance. See Revisions to Patent Term Adjustment, 78 Fed. Reg. 19416, 19417 (Apr. 1, 2013). Therefore, the Office is no longer providing an initial patent term adjustment determination with the notice of allowance. The Office will continue to provide a patent term adjustment determination with the Issue Notification Letter that is mailed to applicant approximately three weeks prior to the issue date of the patent, and will include the patent term adjustment on the patent. Any request for reconsideration of the patent term adjustment determination (or reinstatement of patent term adjustment) should follow the process outlined in 37 CFR 1.705.

Any questions regarding the Patent Term Extension or Adjustment determination should be directed to the Office of Patent Legal Administration at (571)-272-7702. Questions relating to issue and publication fee payments should be directed to the Customer Service Center of the Office of Patent Publication at 1-(888)-786-0101 or (571)-272-4200.

OMB Clearance and PRA Burden Statement for PTOL-85 Part B

The Paperwork Reduction Act (PRA) of 1995 requires Federal agencies to obtain Office of Management and Budget approval before requesting most types of information from the public. When OMB approves an agency request to collect information from the public, OMB (i) provides a valid OMB Control Number and expiration date for the agency to display on the instrument that will be used to collect the information and (ii) requires the agency to inform the public about the OMB Control Number's legal significance in accordance with 5 CFR 1320.5(b).

The information collected by PTOL-85 Part B is required by 37 CFR 1.311. The information is required to obtain or retain a benefit by the public which is to file (and by the USPTO to process) an application. Confidentiality is governed by 35 U.S.C. 122 and 37 CFR 1.14. This collection is estimated to take 30 minutes to complete, including gathering, preparing, and submitting the completed application form to the USPTO. Time will vary depending upon the individual case. Any comments on the amount of time you require to complete this form and/or suggestions for reducing this burden, should be sent to the Chief Information Officer, U.S. Patent and Trademark Office, U.S. Department of Commerce, P.O. Box 1450, Alexandria, Virginia 22313-1450. **DO NOT SEND FEES OR COMPLETED FORMS TO THIS ADDRESS. SEND TO: Commissioner for Patents, P.O. Box 1450, Alexandria, Virginia 22313-1450.** Under the Paperwork Reduction Act of 1995, no persons are required to respond to a collection of information unless it displays a valid OMB control number.

Privacy Act Statement

The Privacy Act of 1974 (P.L. 93-579) requires that you be given certain information in connection with your submission of the attached form related to a patent application or patent. Accordingly, pursuant to the requirements of the Act, please be advised that: (1) the general authority for the collection of this information is 35 U.S.C. 2(b)(2); (2) furnishing of the information solicited is voluntary; and (3) the principal purpose for which the information is used by the U.S. Patent and Trademark Office is to process and/or examine your submission related to a patent application or patent. If you do not furnish the requested information, the U.S. Patent and Trademark Office may not be able to process and/or examine your submission, which may result in termination of proceedings or abandonment of the application or expiration of the patent.

The information provided by you in this form will be subject to the following routine uses:

1. The information on this form will be treated confidentially to the extent allowed under the Freedom of Information Act (5 U.S.C. 552) and the Privacy Act (5 U.S.C. 552a). Records from this system of records may be disclosed to the Department of Justice to determine whether disclosure of these records is required by the Freedom of Information Act.
2. A record from this system of records may be disclosed, as a routine use, in the course of presenting evidence to a court, magistrate, or administrative tribunal, including disclosures to opposing counsel in the course of settlement negotiations.
3. A record in this system of records may be disclosed, as a routine use, to a Member of Congress submitting a request involving an individual, to whom the record pertains, when the individual has requested assistance from the Member with respect to the subject matter of the record.
4. A record in this system of records may be disclosed, as a routine use, to a contractor of the Agency having need for the information in order to perform a contract. Recipients of information shall be required to comply with the requirements of the Privacy Act of 1974, as amended, pursuant to 5 U.S.C. 552a(m).
5. A record related to an International Application filed under the Patent Cooperation Treaty in this system of records may be disclosed, as a routine use, to the International Bureau of the World Intellectual Property Organization, pursuant to the Patent Cooperation Treaty.
6. A record in this system of records may be disclosed, as a routine use, to another federal agency for purposes of National Security review (35 U.S.C. 181) and for review pursuant to the Atomic Energy Act (42 U.S.C. 218(c)).
7. A record from this system of records may be disclosed, as a routine use, to the Administrator, General Services, or his/her designee, during an inspection of records conducted by GSA as part of that agency's responsibility to recommend improvements in records management practices and programs, under authority of 44 U.S.C. 2904 and 2906. Such disclosure shall be made in accordance with the GSA regulations governing inspection of records for this purpose, and any other relevant (i.e., GSA or Commerce) directive. Such disclosure shall not be used to make determinations about individuals.
8. A record from this system of records may be disclosed, as a routine use, to the public after either publication of the application pursuant to 35 U.S.C. 122(b) or issuance of a patent pursuant to 35 U.S.C. 151. Further, a record may be disclosed, subject to the limitations of 37 CFR 1.14, as a routine use, to the public if the record was filed in an application which became abandoned or in which the proceedings were terminated and which application is referenced by either a published application, an application open to public inspection or an issued patent.
9. A record from this system of records may be disclosed, as a routine use, to a Federal, State, or local law enforcement agency, if the USPTO becomes aware of a violation or potential violation of law or regulation.

CORRECTED Notice of Allowability For A Design Application	Application No. 29/740,838	Applicant(s) Isom et al.	
	Examiner ELIZABETH A GLASSBERG	Art Unit 2925	AIA (FITF) Status Yes

-- The MAILING DATE of this communication appears on the cover sheet with the correspondence address--
 All claims being allowable, PROSECUTION ON THE MERITS IS (OR REMAINS) CLOSED in this application. If not included herewith (or previously mailed), a Notice of Allowance (PTOL-85) or other appropriate communication will be mailed in due course. **THIS NOTICE OF ALLOWABILITY IS NOT A GRANT OF PATENT RIGHTS.** This application is subject to withdrawal from issue at the initiative of the Office or upon petition by the applicant. See 37 CFR 1.313 and MPEP 1308. This notice does not set or reset the time period for paying the issue fee. The issue fee must be paid within THREE MONTHS FROM THE MAILING DATE of the Notice of Allowance (PTOL-85) or this application shall be regarded as ABANDONED. This statutory period cannot be extended. See 35 U.S.C.151.

- 1. This communication is responsive to 06/26/2023 Notice of Appeal .
 A declaration(s)/affidavit(s) under **37 CFR 1.130(b)** was/were filed on _____ .
- 2. An election was made by the applicant in response to a restriction requirement set forth during the interview on _____ the restriction requirement and election have been incorporated into this action.
- 3. The claim is allowed.
- 4. Acceptable drawings:
 (a) The drawings filed on 07 July 2020 are accepted by the Examiner.
 (b) Drawing Figures filed on _____ and drawing Figures filed on _____ are accepted by the Examiner.
- 5. The claim for foreign priority under 35 U.S.C. § 119(a)-(d) or (f) is acknowledged.

Certified copies:

- a) All b) Some *c) None of the:
 - 1. Certified copies of the priority documents have been received.
 - 2. Certified copies of the priority documents have been received in Application No. _____ .
 - 3. Copies of the certified copies of the priority documents have been received in this national stage application from the International Bureau (PCT Rule 17.2(a)).
- * Certified copies not received: _____ .

Applicant has THREE MONTHS FROM THE "MAILING DATE" of this communication to file a reply complying with the requirement for corrected drawings noted in item 6 below. Failure to timely comply will result in ABANDONMENT of this application. **THIS THREE-MONTH PERIOD IS NOT EXTENDABLE.** See 37 CFR 1.85(c). **NOTE: This notice does not set or reset the time period for paying the issue fee.**

- 6. CORRECTED DRAWINGS (as "replacement sheets") must be submitted.
 including changes required by the attached Examiner's Amendment / Comment or in the Office action of Paper No./Mail Date _____ .

Identifying indicia such as the application number (see 37 CFR 1.84(c)) should be written on the drawings in the front (not the back) of each sheet. Replacement sheet(s) should be labeled as such in the header according to 37 CFR 1.121(d).

Attachment(s)

- 1. Notice of References Cited (PTO-892)
- 2. Information Disclosure Statements (PTO/SB/08),
 Paper No./Receipt Date _____
- 3. Interview Summary (PTO-413),
 Paper No./Mail Date _____
- 4. Examiner's Amendment/Comment
- 5. Examiner's Statement of Reasons for Allowance
- 6. Other See Continuation Sheet .

NOTE: _____	_____
/ELIZABETH ANNE GLASSBERG/ Examiner, Art Unit 2925	/VY N KOENIG/ Supervisory Patent Examiner, Art Unit 2918

Continuation of Attachment(s) 6. Other: PTO-2297 Notice of Panel Decision from Pre-Appeal Brief Review

Application/Control Number: 29/740,838
Art Unit: 2925

Page 2

EXAMINER'S COMMENTS

Applicant's arguments submitted on 02/06/2023 in response to the Non-Final Rejection were not persuasive; specifically, that the stitching and the asymmetric appearance of the bandana are what makes this design novel. However, upon further consideration the Examiner finds that while the overall shape of Story and Maletsky are close to the claimed design; it is the combination of the shape with the rounded features that creates a design that is patentably distinct and sufficient to overcome the standing rejection which is hereby withdrawn.

Conclusion

The claimed design is patentable over the references cited.

Contact

Any inquiry concerning this communication or earlier communications from the examiner should be directed to ELIZABETH ANNE GLASSBERG whose telephone number is (571)272-9934. The examiner can normally be reached Monday-Friday 9am-5pm EST. Examiner interviews are available via telephone, in-person, and video conferencing using a USPTO supplied web-based collaboration tool. To schedule an interview, applicant is encouraged to use the USPTO Automated Interview Request (AIR) at <http://www.uspto.gov/interviewpractice>.

If attempts to reach the examiner by telephone are unsuccessful, the examiner's supervisor, Dana KWEILAND can be reached on (571)270-0253. The fax phone number for the organization where this application or proceeding is assigned is 571-273-8300.

Information regarding the status of published or unpublished applications may be obtained from Patent Center. Unpublished application information in Patent Center is available to registered users. To file and manage patent submissions in Patent Center, visit: <https://patentcenter.uspto.gov>. Visit <https://www.uspto.gov/patents/apply/patent-center> for more information about Patent Center and <https://www.uspto.gov/patents/docx> for information about filing in DOCX format. For additional questions, contact the Electronic Business Center (EBC) at 866-217-9197 (toll-free). If you would like assistance from a USPTO Customer Service Representative, call 800-786-9199 (IN USA OR CANADA) or 571-272-1000.

/E.A.G./
Examiner, Art Unit 2925

/VY N KOENIG/
Supervisory Patent Examiner, Art Unit 2918

Exhibit

10



US0D1000009S

(12) **United States Design Patent** (10) **Patent No.: US D1,000,009 S**
Isom et al. (45) **Date of Patent: ** Sep. 26, 2023**

(54) **BANDANA FOR AN ANIMAL**
 (71) Applicant: **Remy and Roo, LLC**, Provo, UT (US)
 (72) Inventors: **Andrew Isom**, Provo, UT (US); **Taylor Isom**, Provo, UT (US); **Cameron Gade**, Provo, UT (US); **Ashley Gade**, Provo, UT (US)

(73) Assignee: **REMY AND ROO, LLC**, Provo, UT (US)

(**) Term: **15 Years**

(21) Appl. No.: **29/740,838**

(22) Filed: **Jul. 7, 2020**

(51) **LOC (14) Cl.** **30-01**

(52) **U.S. Cl.**
 USPC **D30/145; D2/500**

(58) **Field of Classification Search**
 USPC D2/500, 861; D30/145, 152, 153
 CPC A01K 25/00; A01K 27/00; A01K 27/001;
 A01K 27/002; A01K 27/003; A01K 27/004; A01K 27/005
 See application file for complete search history.

(56) **References Cited**

U.S. PATENT DOCUMENTS

D309,212 S *	7/1990	Maletsky	D2/602
5,465,689 A *	11/1995	Winder	A01K 13/003
				119/654
D423,150 S *	4/2000	Vignere	D30/145
D425,263 S *	5/2000	Hanada	D30/145
6,209,140 B1 *	4/2001	Ebeling	A01K 27/006
				2/207
6,523,182 B1 *	2/2003	Brawner	A01K 13/006
				2/207
D490,193 S *	5/2004	D'Anza	D30/144
D515,250 S *	2/2006	Story	D30/145
D515,278 S *	2/2006	Jendrucko	D2/500
D542,481 S *	5/2007	Katz	D30/145

7,350,241 B2 *	4/2008	Gendall	A41D 23/00
				2/9
7,427,417 B2 *	9/2008	Jendrucko	A61Q 13/00
				435/283.1
D631,208 S *	1/2011	Gazaway	D30/145
				(Continued)

FOREIGN PATENT DOCUMENTS

CH	1460450004	*	5/2021
DE	402018203540-0004	*	1/2019
KR	3020170000167	*	3/2017

OTHER PUBLICATIONS

Mewtogo 2 Pieces Pet Dog Cooling Collar, available in Amazon.com, date first available Mar. 31, 2020 [online], [site visited Jul. 12, 2022], Available from the internet URL: <https://www.amazon.com/MEWTOGO-Cooling-Collar-Lightweight-Instant/dp/B086MNQR6F> (Year: 2020).*

(Continued)

Primary Examiner — Vy N Koenig
Assistant Examiner — Elizabeth Anne Glassberg
 (74) *Attorney, Agent, or Firm* — PCFB LLC

(57) **CLAIM**

The ornamental design for a bandana for an animal, as shown and described.

DESCRIPTION

FIG. 1 is a perspective view of the design;
 FIG. 2 is a front view of the design;
 FIG. 3 is a rear view of the design;
 FIGS. 4 and 5 are side views of the design;
 FIGS. 6 and 7 are top and bottom views, respectively, of the design; and,
 FIG. 8 is another perspective view of the design in a tied configuration.
 The broken lines in the drawings depict stitching that forms part of the claimed design.

1 Claim, 3 Drawing Sheets

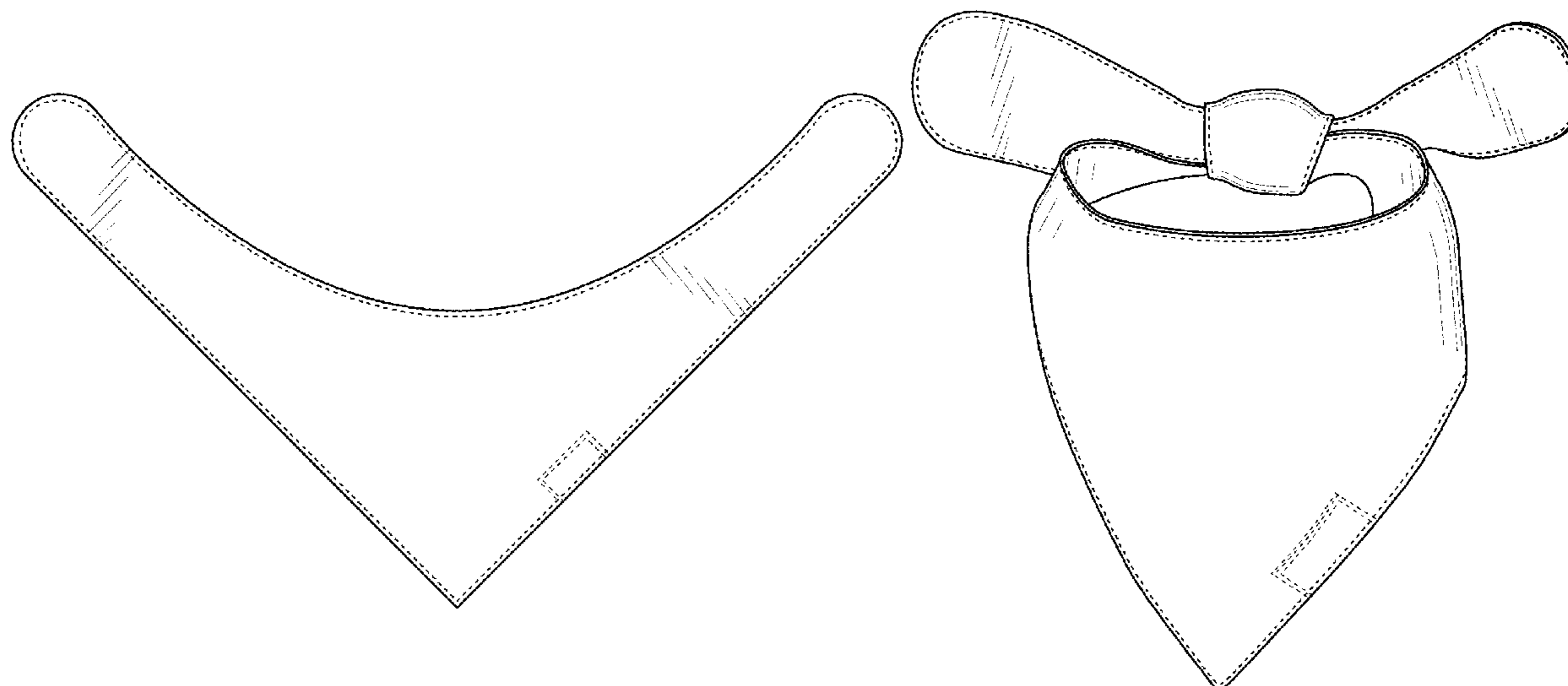

US D1,000,009 S

Page 2

(56)

References Cited

U.S. PATENT DOCUMENTS

D631,209	S *	1/2011	Gazaway	D30/145
D653,410	S *	1/2012	Morton	D30/152
D688,850	S *	9/2013	Parker	D2/881
D721,221	S *	1/2015	Frink, Sr.	D2/605
D721,471	S *	1/2015	Feinberg	D2/861
D746,556	S *	1/2016	Vifquain	D2/881
D839,533	S *	2/2019	Nardone	D29/101.2
D871,684	S *	12/2019	Searvogel	D30/152
11,324,198	B2 *	5/2022	Albert	A01K 13/006
2003/0137157	A1 *	7/2003	Hopkins	E01H 1/1206 294/1.3
2008/0092268	A1 *	4/2008	Mangham	A41D 23/00 2/129
2009/0159016	A1 *	6/2009	Lang	A01K 27/006 119/863
2010/0006039	A1 *	1/2010	Edwards	A01K 13/006 119/850
2014/0020636	A1 *	1/2014	Desaulniers	A01K 27/006 119/858

OTHER PUBLICATIONS

Remy+Roo Dog Bandanas, available in Amazon.com, date first available May 4, 2019 [online], [site visited Jul. 14, 2022], Available from the internet URL: <https://www.amazon.com/Remy-Roo-Dog-Bandanas-Adjustable/dp/B08LG55N2X?th=1> (Year: 2019).*

KeaBabies Organic Baby Bandana Drool Bibs, available in Amazon.ca, date first available Nov. 9, 2018 [online], [site visited Jul. 14, 2022], Available from the internet URL: <https://www.amazon.ca/Baby-Bandana-Drool-Bibs-KeaBabies/dp/B081F3K64Y?th=1> (Year: 2018).*

* cited by examiner

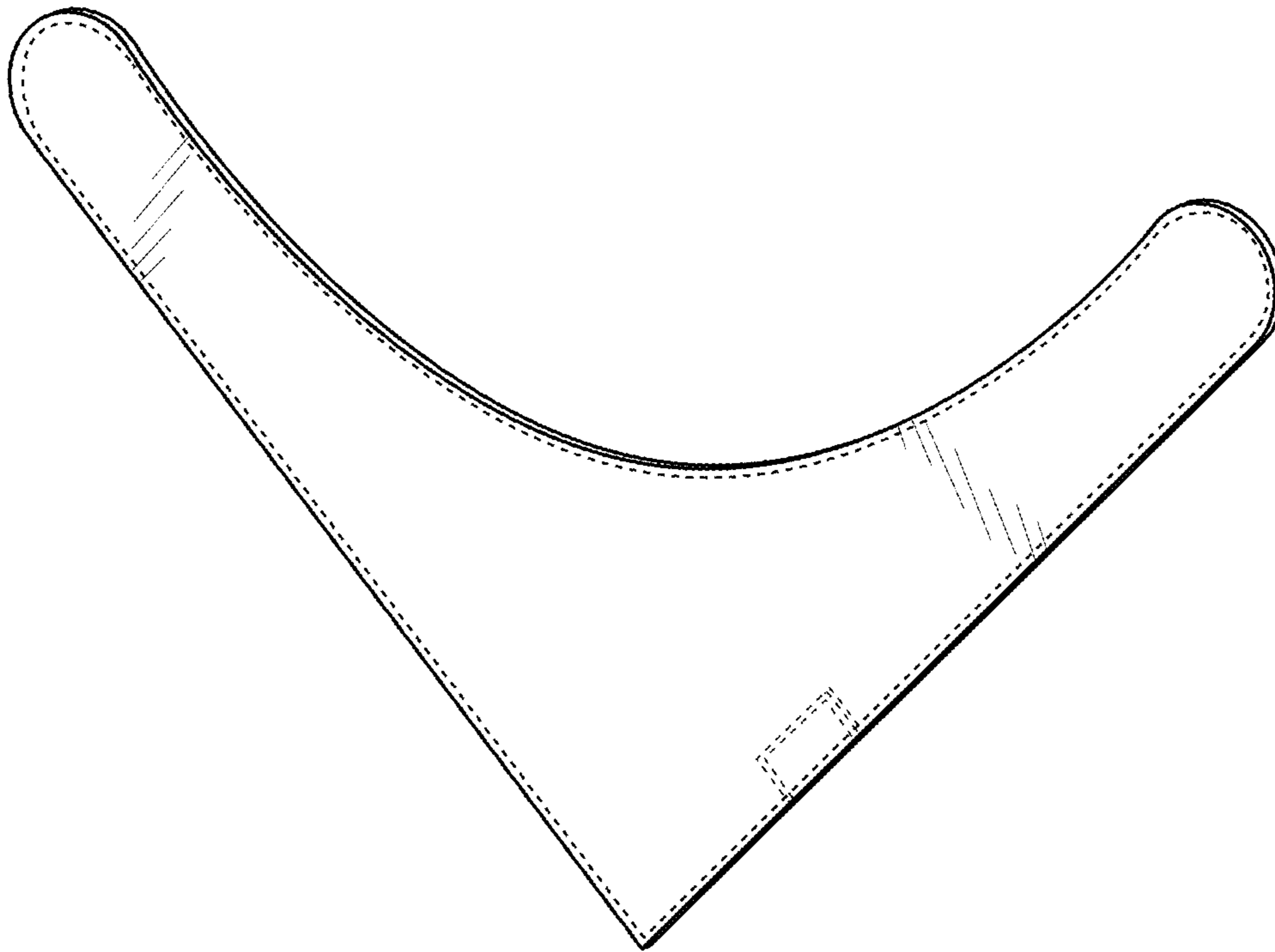

FIG. 1

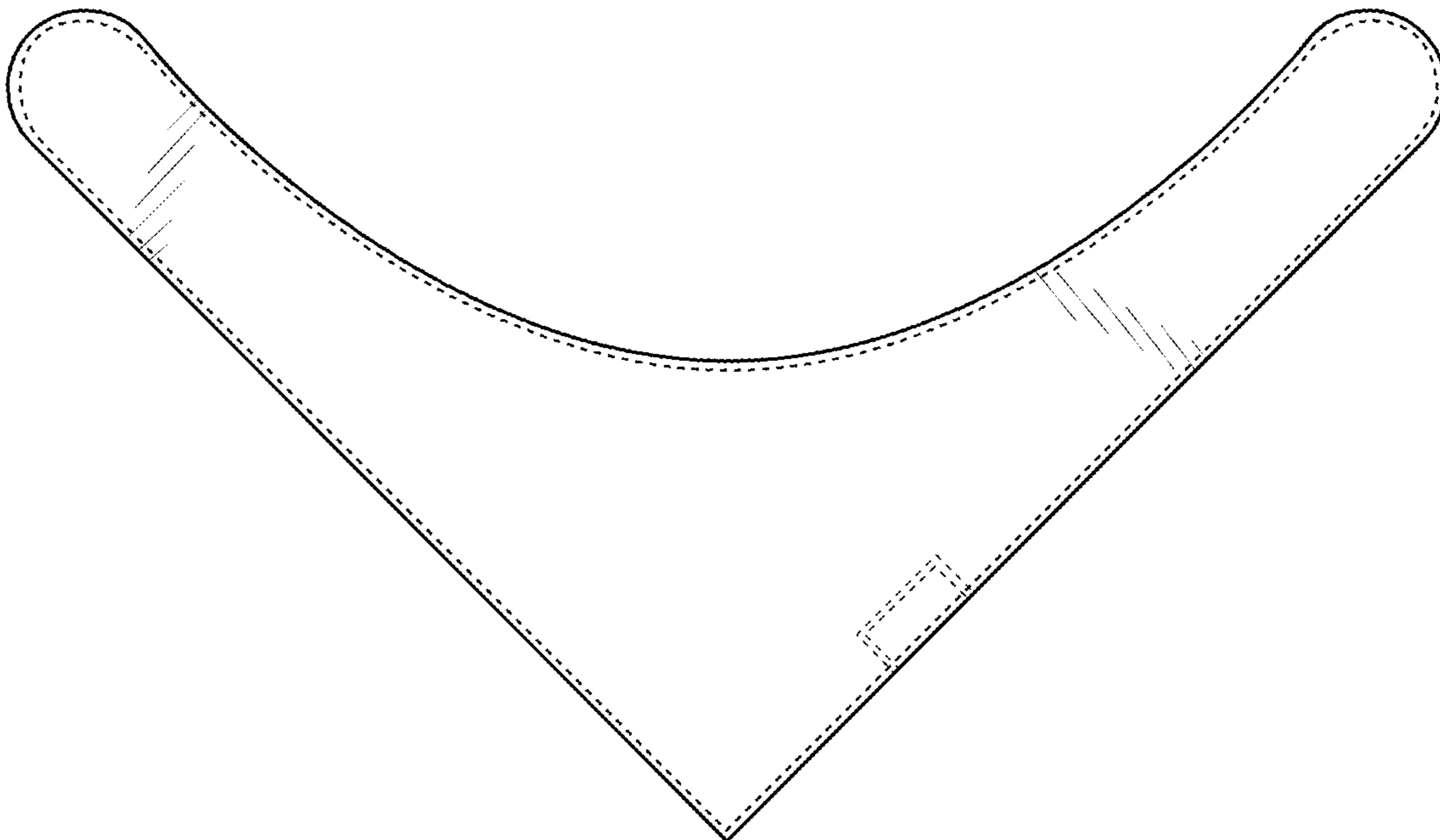

FIG. 2

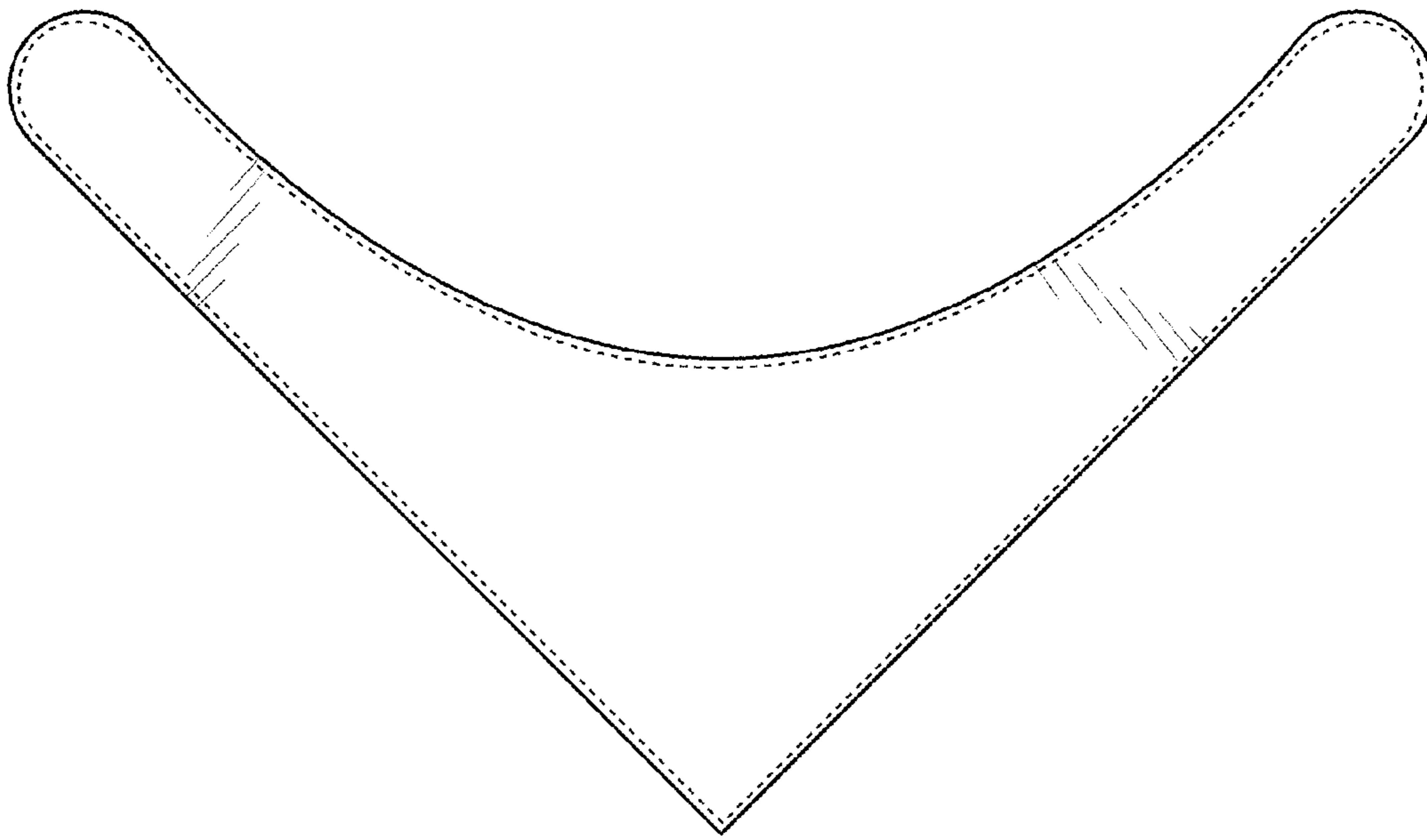

FIG. 3



FIG. 4



FIG. 5



FIG. 6



FIG. 7

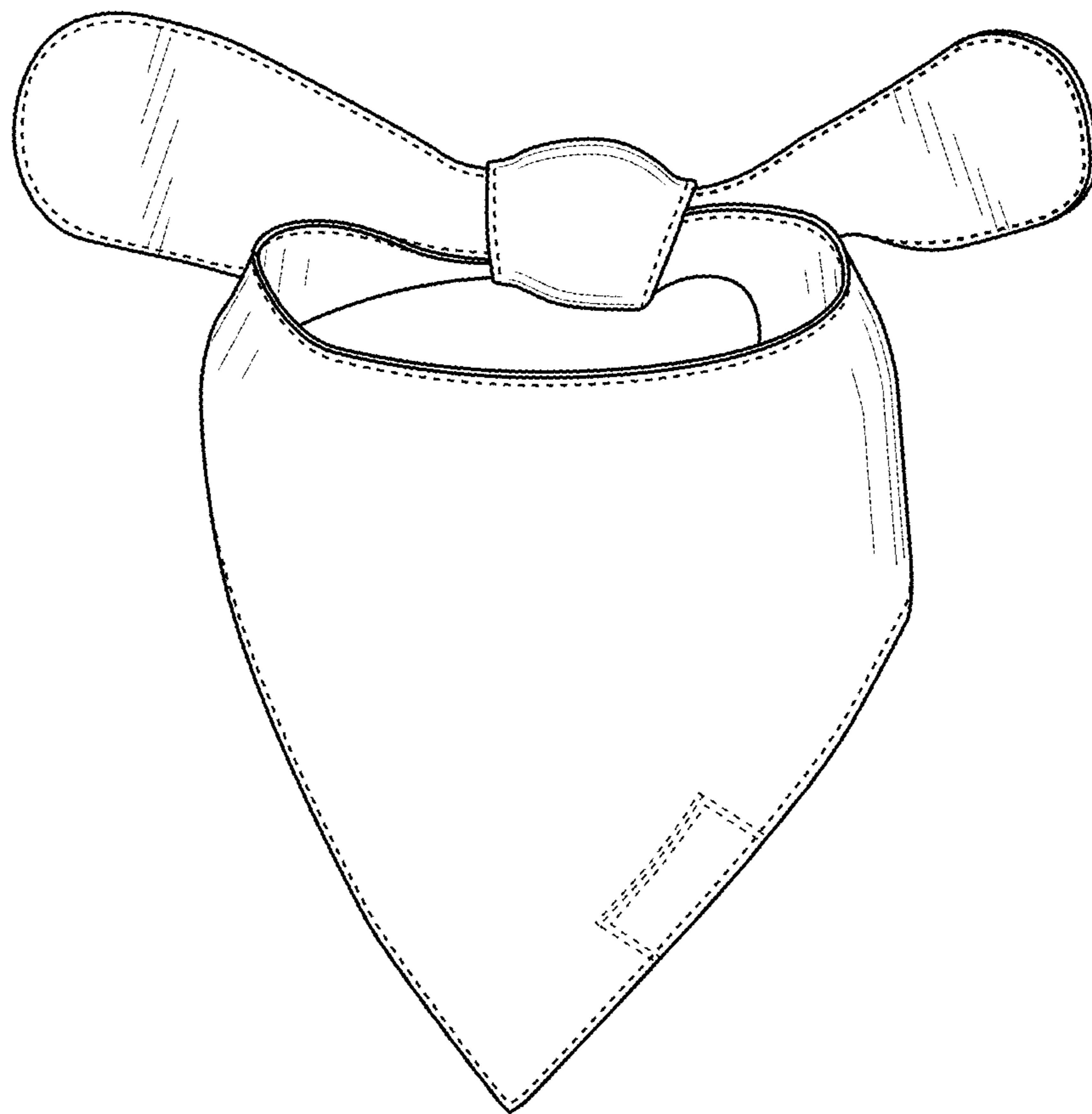

FIG. 8

Exhibit

1 1



Deliver to Britney
Moses Lake 98837

All remy roo bandana



EN

Hello, Jill
Account & Lists

Returns
& Orders



All Last Minute Deals Medical Care Buy Again Today's Deals Amazon Basics



26:04:24

Pet Supplies Pet Profiles Dogs Cats Fish & Aquatics Small Animals Birds Reptiles Horses Deals & Coupons Pet Care Tips

Back to results

Sponsored



Remy+Roo Dog Bandanas - 2 Pack | Holiday Plaids Set | Premium Durable Fabric | Patented Shape | Adjustable Fit | Multiple Sizes Offered (Large)

Visit the Remy+Roo Store

5.0 5 ratings

600+ bought in past month

\$18.95 (\$9.48 / Count)

prime Two-Day

FREE Returns

Get a \$150 Gift Card: Pay \$0.00 \$18.95 upon approval for Prime Visa. No annual fee.

Roll over image to zoom in



Size: Large

Large	Small	X-Large
\$18.95 (\$9.48 / Count)	\$18.95 (\$9.48 / Count)	\$20.95 (\$10.48 / Count)
prime	prime	

Size	Large
Theme	Halloween
Breed Recommendation	Golden-doodle, Poodle, Labrador Retriever, Labradoodle, Golden Retriever, Bulldog, Beagle, Australian
Brand	Remy+Roo
Color	Maroon, Navy, Light Blue, Gray, White, Black

About this item

- ADJUSTABLE SIZING: Small fits necks up to 14". Large fits necks up to 21". XL fits necks up to 31". Remy+Roo bandanas have a unique design with two long ends making the dog bandana adjustable to the exact size of your pet's neck. The bandana has a curved design to mimic your dogs natural neck-line. It is designed to fit comfortably while eliminating bulk, folds and excess fabric. Remy+Roo bandanas come in multiple sizes.
- TRENDY DESIGNS: Each dog bandana features a custom Halloween design exclusive to Remy+Roo that are hand created by our talented artists. The

\$18.95 (\$9.48 / Count)

prime Two-Day
FREE Returns

FREE delivery Friday, December 15. Order within 10 hrs 6 mins

Arrives before Christmas

Deliver to Britney - Moses Lake 98837

In Stock

Qty: 1

Add to Cart

Buy Now

Ships from Amazon
Sold by Remy+Roo
Returns Returnable until Jan 31, 2024
Payment Secure transaction

Add a gift receipt for easy returns

Add to List

Sponsored

patterns in this two pack have been carefully designed to compliment each other, ensuring they are versatile, trendy and perfect for Halloween!

- DURABLE AND SUSTAINABLE: Our dog bandanas are dual layered and made from a durable polyester fabric that will outlast all of your dog's adventures.
- PATENTED SHAPE: All of our bandanas are protected by US-D1000009-S

Additional Details

 Small Business
This product is from a small business brand. Support small. [Learn more](#)

 [Report an issue with this product or seller](#)

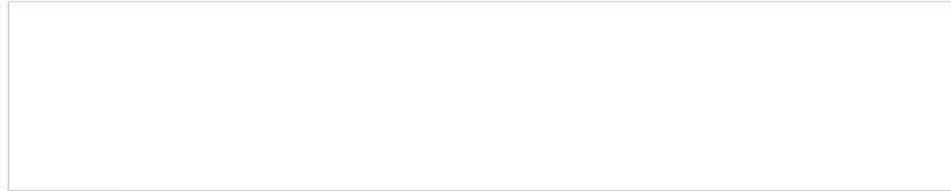

Sponsored 

Frequently bought together



+



+



Total price: **\$56.85**
Add all 3 to Cart

 Some of these items ship sooner than the others. [Show details](#)

This item: Remy+Roo Dog Bandanas - 2 Pack | Holiday Plaids Set | Premium Durable...
\$18⁹⁵ (\$9.48/Count) 

Remy+Roo Dog Bandanas - 2 Pack | Evergreen Set | Premium Durable Fabric | Unique Shape...
\$18⁹⁵

Remy+Roo Dog Bandanas - 2 Pack | Holly Set | Premium Durable Fabric | Unique Shape...
\$18⁹⁵ 

Related products from Remy+Roo

Sponsored 



Remy+Roo Dog Bandanas - 2 Pack | Winter Christmas Set | Premium Durable...
\$18.95 (\$9.48/Count) 



Remy+Roo Dog Bandanas - 2 Pack | Wonderland Christmas Set | Premium Durable...
\$18.95 (\$9.48/Count) 



Remy+Roo Dog Bandanas - 2 Pack | Holly Set | Premium Durable Fabric |...
★★★★★ 197
\$20.95 



Remy+Roo Dog Bandanas - 4 Pack | Shannon Set | Premium Durable Fabric |...
★★★★★ 553
Amazon's Choice in Dog Bandanas
\$24.95 



Remy+Roo Dog Bandanas - 2 Pack | Evergreen Set | Premium Durable Fabric |...
★★★★★ 578
\$18.95 

Products related to this item

Sponsored 



Remy+Roo Dog
Bandanas - 2 Pack |
Winter Christmas Set |
Premium Durable...
\$20.95 (\$10.48/Count)
✓prime

Remy+Roo Dog
Bandanas - 2 Pack |
Holly Set | Premium
Durable Fabric |...
★★★★★ 197
\$18.95 ✓prime

Remy+Roo Dog
Bandanas - 2 Pack |
Wonderland Christmas
Set | Premium Durable...
\$18.95 (\$9.48/Count)
✓prime

Remy+Roo Dog
Bandanas - 2 Pack |
Evergreen Set | Premium
Durable Fabric |...
★★★★★ 578
\$18.95 ✓prime

ADOGGYGO Christmas
Dog Bandanas with
Tassels Edges, Stylish
Plaid Dog Christmas...
★★★★★ 140
Amazon's Choice in Dog
Bandanas
#1 Best Seller
\$14.99 ✓prime

Product Description

Product details

Package Dimensions : 10.94 x 7.72 x 0.59 inches; 1.9 Ounces

Date First Available : May 2, 2019

Manufacturer : Remy+Roo

ASIN : B0CFZPVB96

Customer Reviews:

5.0  5 ratings

Videos

Videos for related products

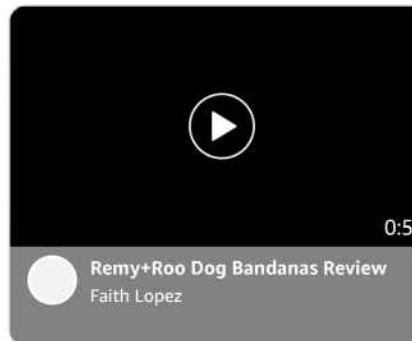

Upload your video

Important information

To report an issue with this product, [click here](#).

Compare with similar items

This Item — Recommendations



Remy+Roo Dog Bandanas - 2 Pack | Holiday Plaids Set | Premium Durable Fabric |...

Add to Cart



Remy+Roo Dog Bandanas - 4 Pack | Ryan Set | Premium Durable Fabric | Unique Sha...

Add to Cart



Elegant little tail 1PCS Pet Dog Bandana Washable Reversible Cotton Bibs Scarf...

Add to Cart



ADOGGYGO Christmas Dog Bandana 2 Pack, Stylish Plaid Dog Scarf, Premium Cotton...

Add to Cart

Price	\$18 ⁹⁵	\$24 ⁹⁵	\$9 ⁹⁹	\$12 ⁹⁹
Delivery	✓prime FREE Delivery	✓prime FREE Delivery	Prime FREE Delivery	✓prime FREE Delivery
Customer Ratings	5.0 ★★★★★ 5	4.8 ★★★★★ 776	4.7 ★★★★★ 790	4.9 ★★★★★ 193
Sold By	Remy+Roo	Remy+Roo	Elegant little tail	Adoggygo
Size	Large	Small	Large (1 Count)	Large
Material	—	Polyester	Fur, Cotton	Cotton
Fabric	Polyester	Polyester	Cotton	100% cotton
Pattern	Herringbone, Triangles, Leaves, Speckled, Polkadot	Herringbone, Triangles, Leaves, Speckled, Polkadot	Geometric	Christmas
Neck Size	—	17 inches	—	17 inches
Closure Type	Drawstring	Drawstring	—	—
Neck Style	—	Round Neck	Neckerchief	Neckerchief
Care Instructions	Hand Wash Only	Hand Wash Only	Machine Wash	Hand Wash Only, Machine Wash

Related products with free delivery

Sponsored ⓘ



Remy+Roo Manhattan 5 FT Rope Dog Leash | Custom Waste Bag Ring | Double Stitched Le...
★★★★★ 43
Amazon's Choice in Standard Dog Leashes
\$29.95 ✓prime



Remy+Roo Dog Bandanas - 4 Pack | Shannon Set | Premium Durable Fabric |...
★★★★★ 553
\$26.95 ✓prime



Rocco & Roxie Jerky Dog Treats Made in USA Healthy Treats for Potty Training High V...
★★★★★ 7,051
Amazon's Choice in Dog Jerky Treats
\$19.97 (\$1.25/Ounce)
✓prime



Remy+Roo Dog Bandanas - 2 Pack | Winter Christmas Set | Premium Durable...
\$18.95 (\$9.48/Count)
✓prime



Remy+Roo Dog Bandanas - 2 Pack | Evergreen Set | Premium Durable Fabric |...
★★★★★ 578
\$18.95 ✓prime

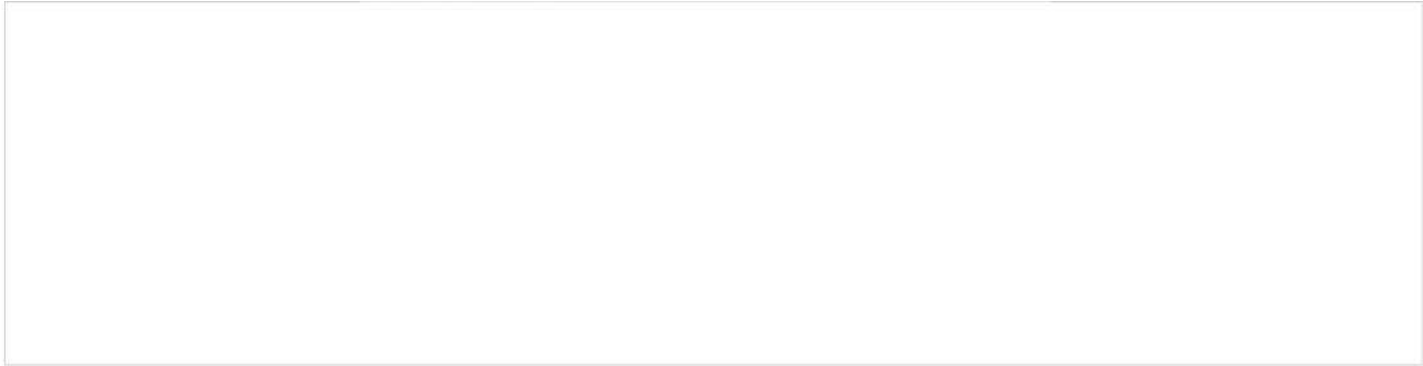

Sponsored

Looking for specific info?

Customer reviews

★★★★★ 5 out of 5

5 global ratings



How customer reviews and ratings work

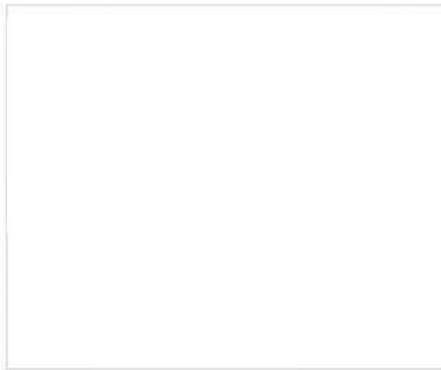

Sponsored

Reviews with images

See all photos >



Top reviews

Top reviews from the United States

Katie Smith

★★★★★ High quality and accurate sizing

Reviewed in the United States on November 25, 2023

Size: X-Large | Verified Purchase

We love these bandanas for our dogs. We've bought multiple of them for our two golden retrievers. They've also made great gifts for our pet loving friends. Sizing is accurate but are adjustable if needed. They are high quality fabric and clean up really easily. Will continue to purchase as they come out with new designs.

Helpful | Report

Janine B.

★★★★★ Very nice fitting bandanna

Reviewed in the United States on December 7, 2023

Size: Small | Verified Purchase

Love these for my pups! Tie nicely and look adorable. I ordered a small for my 13 lb. maltipoo and my 12 lb Parson Russell mix.

Helpful | Report

 Joel Reichert

★★★★★ **Cutest accessory!**

Reviewed in the United States on November 18, 2023

Size: Large

We love Remy and Roo bandanas. They're high quality fabric, super cute designs and the sizing is perfect. We have a 12 lb golden doodle and the size small works great. We've purchased several packs of Remy and Roo and have always been impressed.



Helpful

Report

 kimberly teichrow

★★★★★ **Best dressed holiday pups!!**

Reviewed in the United States on November 21, 2023

Size: Large | **Verified Purchase**

I ADORE these bandanas for my dogs!!! Easy to wear & they look so festive! I need to order more for all of our friends with dogs- what a fun holiday gift!! Thank you!!



Helpful

Report

[See more reviews >](#)

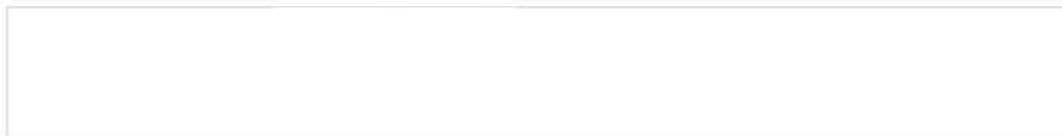

Sponsored 

Back to top

Get to Know Us

- Careers
- Amazon Newsletter
- About Amazon
- Accessibility
- Sustainability
- Press Center
- Investor Relations
- Amazon Devices
- Amazon Science

Make Money with Us

- Start Selling with Amazon
- Sell apps on Amazon
- Supply to Amazon
- Protect & Build Your Brand
- Become an Affiliate
- Become a Delivery Driver
- Start a Package Delivery Business
- Advertise Your Products
- Self-Publish with Us
- Host an Amazon Hub
- > See More Ways to Make Money

Amazon Payment Products

- Amazon Visa
- Amazon Store Card
- Amazon Secured Card
- Amazon Business Card
- Shop with Points
- Credit Card Marketplace
- Reload Your Balance
- Gift Cards
- Amazon Currency Converter

Let Us Help You

- Your Account
- Your Orders
- Shipping Rates & Policies
- Amazon Prime
- Returns & Replacements
- Manage Your Content and Devices
- Your Recalls and Product Safety Alerts
- Help



English

United States

Amazon Music
Stream millions of songs

Amazon Ads
Reach customers wherever they spend their time

6pm
Score deals on fashion brands

AbeBooks
Books, art & collectibles

ACX
Audiobook Publishing Made Easy

Sell on Amazon
Start a Selling Account

Amazon Business
Everything For Your Business

Amazon Fresh
Groceries & More Right To Your Door

AmazonGlobal
Ship Orders Internationally

Home Services
Experienced Pros Happiness Guarantee

Amazon Web Services
Scalable Cloud Computing Services

Audible
Listen to Books & Original Audio Performances

Box Office Mojo
Find Movie Box Office Data

Goodreads
Book reviews & recommendations

IMDb
Movies, TV & Celebrities

IMDbPro
Get Info Entertainment Professionals Need

Kindle Direct Publishing
Indie Digital & Print Publishing Made Easy

Amazon Photos
Unlimited Photo Storage Free With Prime

Prime Video Direct
Video Distribution Made Easy

Shopbop
Designer Fashion Brands

Amazon Warehouse
Great Deals on Quality Used Products

Whole Foods Market
America's Healthiest Grocery Store

Woot!
Deals and Shenanigans

Zappos
Shoes & Clothing

Ring
Smart Home Security Systems

eero WiFi
Stream 4K Video in Every Room

Blink Smart Security
for Every Home

Neighbors App
Real-Time Crime & Safety Alerts

Amazon Subscription Boxes
Top subscription boxes – right to your door

PillPack
Pharmacy Simplified

Amazon Renewed
Like-new products you can trust

Exhibit

12

Search our store



Bandanas ▾ Leashes Scrunchies Collections Size Guide Info ▾ Sale

Unleash Joy This Holiday Season
Experience the magic of the season with our exclusive holiday patterns!
[Shop Now](#)

Best Sellers

[Shop now](#)

Wonderland
[Quick View](#)

Winter
[Quick View](#)

Amber
[Quick View](#)

Jo
[Quick View](#)

Our Collections

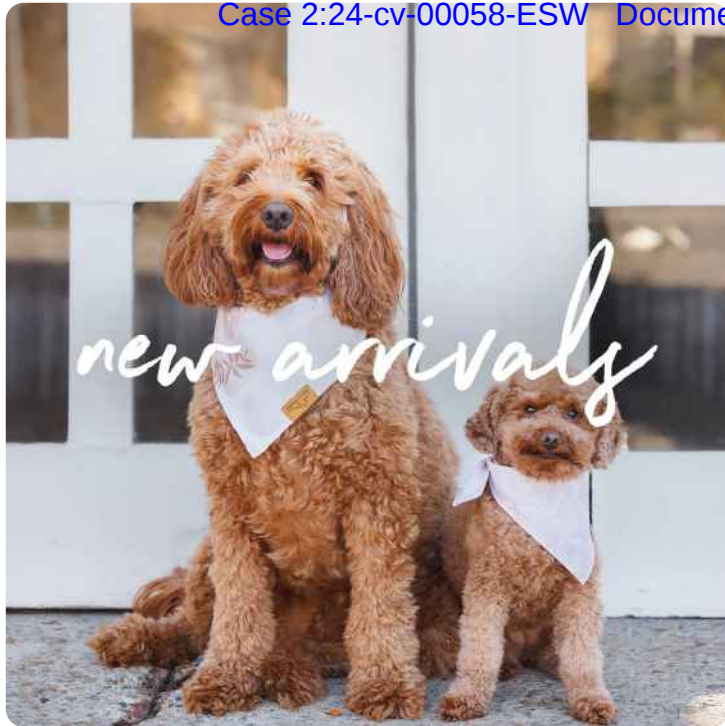

[New Arrivals](#)

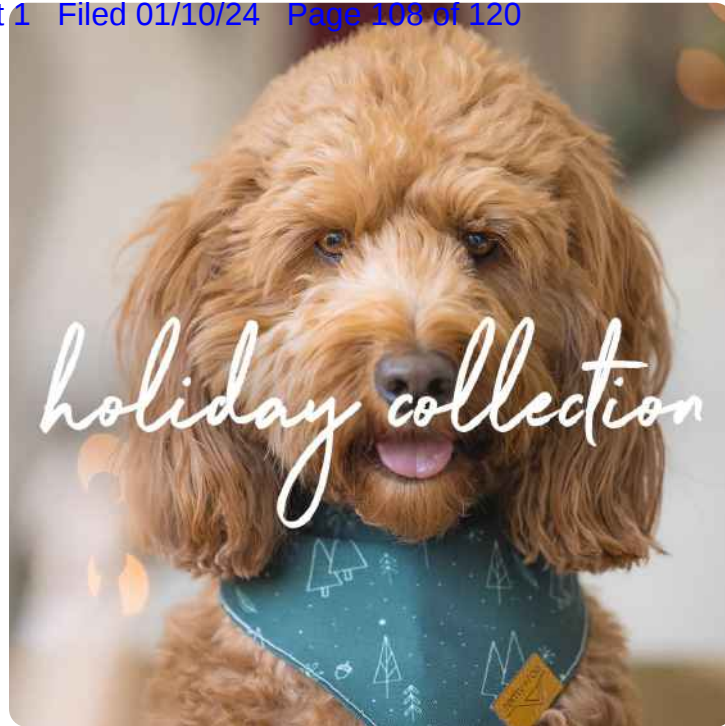

[Holiday Collection](#)

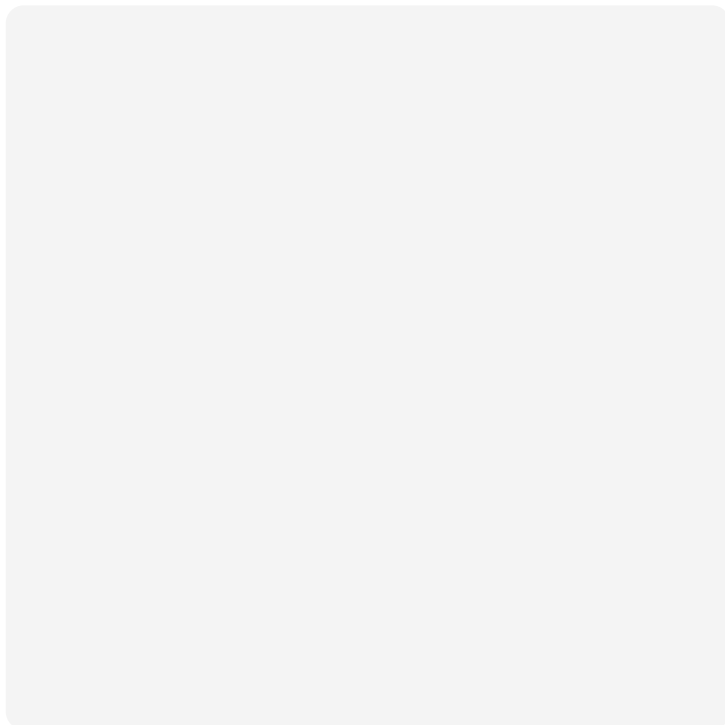

[Remy's Favorites](#)

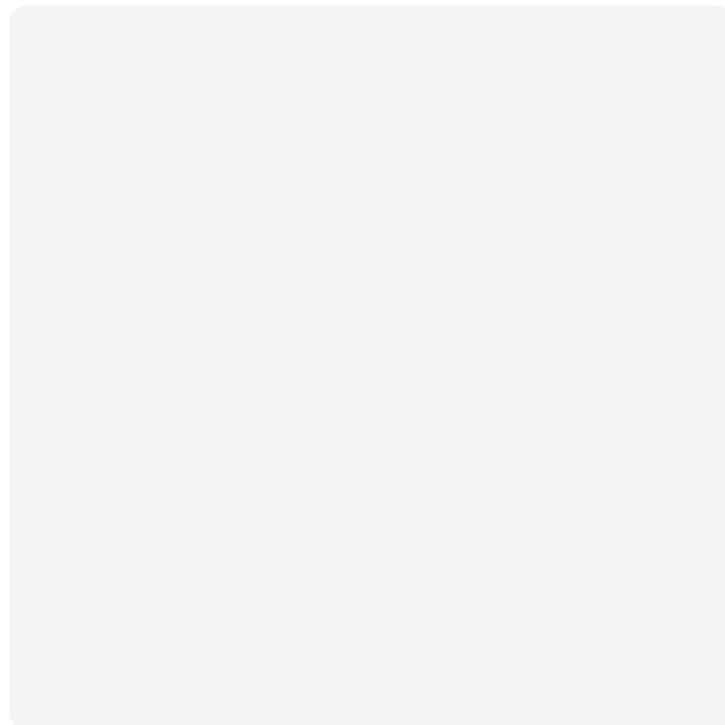

[Roo's Favorites](#)

Dog fashion shouldn't cost a tail and a leg.

Remy+Roo bandanas were created to add a sense of style to your pup without breaking the bank. Our durable polyester fabric and unique shape ensure a perfect fit for your pet.

[Shop Now](#)

What Humans Are Saying



These bandanas are amazing! The quality is very high compared to some dog bandanas that I've gotten for my dog. It also has long ends which makes it nice to tie and keep on the dogs neck. The pictures online are exactly what you get which is awesome. My dog is 6.5 months and weighs 7.6 lbs for a reference. Highly recommend!

– Lindsee



We love these bandanas! From the fabric quality to the custom shape, it's clear these were made with our cute doggos in mind. I'm not worried about my doggo destroying them after one use because the fabric is strong and durable. We love the scoop neck and it fits our little Biscuit great (small size)! We just adopted him a few months ago and love making him part of our family. Love these festive designs and can't wait to purchase the new patterns!

– Andy



I've been buying this brand of bandana since my dog was young. The shape makes for a cute bow when you tie them. They're super machine washable and don't hold stains. They've had plenty of grass stains that come right out in the wash and look and feel as good as when I first started buying them.

– Ethan



These are absolutely adorable!! Great durable, sturdy material. High quality!! Would highly recommend and will be repurchasing!! Don't hesitate!

– Britney



The quality is spot on! And the price is well worth it. I am kinda obsessed with my girl Sadie and bandannas usually don't fit her well. However the Remy and Roo bandannas are cut to fit dogs perfectly and the tie really nice. Sadie has gotten tons of likes on her Instagram 🥰 I will be ordering her more in the future.

– Amanda



These are SO cute!! Super durable also! My boys play hard at the dog park and these don't retain and of the dirt or debris. Also did I mention they're SO dang cute !!!

– Tre

Stay Connected

Email address

Sign up

HELP

FAQs

Size Guide

Shipping & Returns

Terms of Service

Refund policy

COMMUNITY

Our Story

Contact Us



[Privacy Policy](#) | [Terms Of Service](#)

Copyright © 2023 Remy+Roo.

Search our store



Bandanas ▼

Leashes

Scrunchies

Collections

Size Guide

Info ▼

Sale

Home > Best Sellers > Jolly

< Previous · Next >



Jolly

★★★★★ 6 reviews

\$14.95

Size

- Small
- Large
- XL

Quantity ▼

Free Unlimited Return for Store Credit or Exchanges for \$1.98 via redo



Description Care

Premium quality products at affordable prices

- Made from dual-layered 100% polyester fabric.
 - More stain and wrinkle resistant than cotton bandanas.
 - Easier to spot clean in quick situations and maintains color and shape after washing.
- Curved design to mimic your dog's natural neckline keeping the bandana closer to your pet's body.
 - Long ties create a bow shape.
 - Fits comfortably while eliminating bulk, folds, and excess fabric.
- Patented Shape protected by US-D1000009-S.

Share



Customer Reviews



Based on 6 reviews



Most Recent ▾



★★★★★ 11/24/2023

Verified Customer

A Perfect Fit

We used this picture for our Christmas cards, and the bandana made the picture look great! Milo loves the fit and comfort of the bandana.





★★★★★ 12/15/2022

Verified **NICOLE BIFFLE**

So cute!

I ordered a few Christmas bandanas for my pups and they look absolutely adorable. Will order more in the future!



★★★★★ 12/13/2022

Verified **K.K.C.A.**



I adore Remy and Roo!!! Your Scarves Are Perfectly Perfect In Every Single Way!!! ❤️💚❤️



★★★★★ 12/04/2022

Verified **Sue M**

Love the fabric!

Besides the fabulous designs, I love the unique fabric used for the bandanas. It's soft but resists stains and washes up beautifully.



★★★★★ 12/04/2022

Verified **Adreanna Poggendick**

I love it so much!!!

1 2 > >|

You may also like

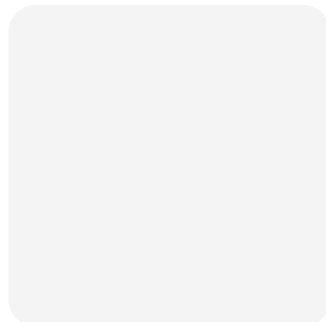
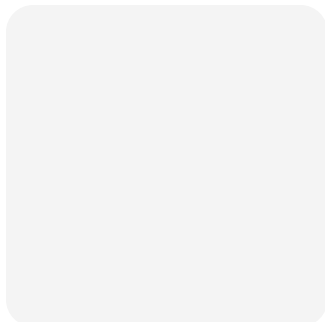
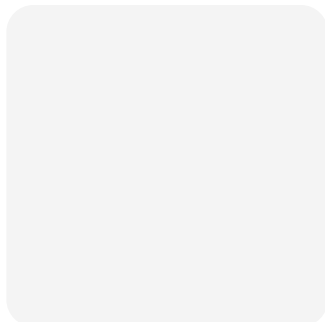
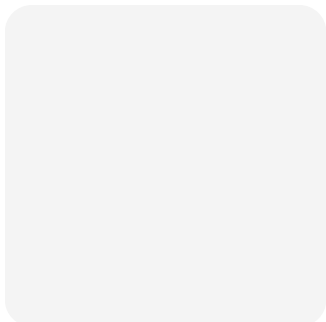

Noel

From \$14.95

Juniper

From \$14.95

Rubi

★★★★★ 13 reviews

From \$24.95

Jack

★★★★★ 4 reviews

From \$18.95

Recently viewed



Spooky

From \$18.95

Stay Connected

Email address

Sign up

HELP

FAQs

Size Guide

Shipping & Returns

Terms of Service

Refund policy

COMMUNITY

Our Story

Contact Us



Exhibit

13



charlottespet • Follow



charlottespet When you need to show others how awesome your furry friend is.

339w



junie.boonie Done! 🥰❤️

339w Reply



charlottespet @insta.aussies IG isn't letting me see your message. Can you please email me at "admin at CharlottesPet dot com."

339w Reply



charteredwellness This is so cute, I love it!

339w 1 like Reply



charlottespet #dogsofinstagram #dogbow #charlottespet #catbow #petapparel #petsagram #dog #dogcollar #love #pamperedpets #photooftheday #picoftheday #happydogs #dogfashion #petfashion #bandana #dogbandana #cat #dogleash #dogwalker #superhero #super #renaechristine #zbesties #handmade #etsyshop #dogsofig #dogsagram

339w Reply



58 likes

MAY 3, 2017



Add a comment...

Post





charlottespet • Follow



charlottespet Bandanas all around. Link in profile. Save 15% with code 'FREEDOM'

336w



charlottespet #dogsofinstagram #charlottespet #petapparel #petsagram #dogcollar #love #pamperedpets #happydogs #dogfashion #petfashion #dogbandana #catsofinstagram #redwhiteblue #memorialdayweekend #bestwoof #buzzfeedpets #puppylove #puppy #puppiesofinstagram #goldendoodlesofinstagram #pitbullsofinstagram #dogphoto #catphoto #buzzfeed #puppystyle #stripes #dogsagram #dogsofig #bordercolliesofinstagram #like4like



336w Reply



43 likes
MAY 28, 2017



Add a comment...

Post





charlottespet · Follow



charlottespet Add a little sparkle this Halloween. Search 'shimmer ghosts bandana' Link in profile

316w



jester_creations6185 Ooohhh!! Making more for this season? Super cute!



271w Reply



wisteriaandfig How cute!!



316w Reply



charlottespet #dogsofinstagram #charlottespet #petsagram #dogbow #dogbowtie #dogaccessories #pamperedpets #petapparel #shopsmall #handmade #petfashion #bandana #dogbandana #dogleash #dogwalker #dogsagram #renaechristine #zbesties #bestwoof #buzzfeedpets #dogphoto #dogclothes #halloweencostume#instadog #petshop #petstore #etsy#etsyshop #happydogs #dogfashion



316w Reply



42 likes

OCTOBER 16, 2017



charlottespet • Follow



charlottespet Summer Days Collection now available! Shop now to save 25%.

225w



23 likes

JULY 15, 2019



Add a comment...

Post