

1 Patrick Cummins
2 CA Bar No.: 294400
3 Patrick@CumminsIP.com
4 Cummins IP PLLC
5 3426 PEPPERHILL RD
6 LEXINGTON, KY 40502
7 TEL: 502.445.9880
8 *Counsel for Plaintiff,*
9 *DS Advanced Enterprises, Ltd.*

10 **U.S. DISTRICT COURT**
11 **CENTRAL DISTRICT OF CALIFORNIA**

12 DS ADVANCED ENTERPRISES,
13 LTD.,
14 A CORPORATION,
15 *Plaintiff,*
16 v.
17 LEDVANCE LLC,
18 A CORPORATION, and
19 LOWE'S GLOBAL SOURCING
20 (SHANGHAI) TRADING CO.,
21 LTD.,
22 A CORPORATION,
23 *Defendants.*

Case No.: 5:23-cv-02058

**COMPLAINT FOR PATENT
INFRINGEMENT**

DEMAND FOR JURY TRIAL

1 Plaintiff, DS ADVANCED ENTERPRISES, LTD (“PLAINTIFF”), by and
2 through counsel CUMMINS IP PLLC, for its complaint against DEFENDANT
3 LEDVANCE LLC (“LEDVANCE”), and LOWE’S GLOBAL SOURCING
4 (SHANGHAI) TRADING CO., LTD. (“LOWES CHINA”), allege as follows:
5

6 **PARTIES**

7 1. PLAINTIFF, DS Advanced Enterprises, LTD. (“DSAE”), is an Ontario
8 corporation with a principal place of business at 34 Park Court, Niagara-on-the-Lake,
9 ON L0S 1J0, Canada.

10 2. PLAINTIFF is the owner of U.S. Patent 11,054,118 (see Exhibit 1) and sells
11 lighting products in the United States and internationally.

12 3. DEFENDANT LEDVANCE LLC is a Delaware Corporation with a principal
13 place of business at 200 Ballardvale Street, Wilmington, MA 01887, and is operating a
14 distribution center in San Bernadino County at 1651 S Archibald Ave, Ontario, CA
15 91761 (see, *e.g.*, Exhibits 4-7).

16 4. DEFENDANT Lowe’s Global Sourcing (Shanghai) Trading Co., Ltd., (d/b/a
17 “LGS Shanghai Ltd.”, “Lao Gou Shi (Shanghai) Trading Co.”, or 劳购氏(上海)贸易有
18 限公) is a Chinese company with a principal place of business at Room 706, No. 233,
19 Taicang Road, Huangpu District, Shanghai, China 210020; and a date of establishment
20 of July 9, 2012. See Exhibits 32 and 33, which include a Chinese version, and translated
21 version, of a Chinese government record of registration of Lowe’s Global Sourcing
22 (Shanghai) Trading Co., Ltd.
23
24
25
26
27
28



JURISDICTION AND VENUE

1
2 5. This Court has original jurisdiction over the subject matter of this action pursuant
3 to 28 U.S.C. §1331 and §1338, as the dispute between the parties presents a substantial
4 question of federal patent law.

5 6. The Court also has jurisdiction pursuant to 28 U.S.C. §2201(a), as Plaintiff seeks a
6 declaration of rights in relation to Defendants.

7 7. This Court has personal jurisdiction over the Defendants. Defendants are
8 regularly conducting business in California State and this District both directly and
9 indirectly, and, upon information and belief, deriving substantial revenue from business
10 transacted within California State and this District by advertising, distributing, offering
11 for sale, and/or selling of unauthorized goods in California State and this District, and
12 thus are subject to personal jurisdiction in this District.

13 8. DEFENDANT Lowe’s Global Sourcing (Shanghai) Trading Co., Ltd. (“LOWE’S
14 CHINA”) has regularly utilized the ports of Los Angeles and Long Beach for the past
15 several years (*e.g.*, see Exhibit 45, which is data that is publicly available via
16 importyeti.com), thereby establishing a regular place of business with this jurisdiction.

17 9. DEFENDANT LEDVANCE LLC owns and operates a “Manufacturing &
18 Processing” “Business Property” identified as Parcel #021126206P000 at the address
19 1651 S Archibald Ave, Ontario, CA, in San Bernadino County (see, *e.g.*, Exhibits 4-7).

20 10. Venue is proper in this district under 28 U.S.C. §1391(b)(3) and 28 U.S.C.
21 §1400(b).

22 11. Venue is also proper per 28 USC 1391(c)(3) and *In re HTC Corp.*, 889 F.3d 1349,
23 1354 (Fed. Cir. 2018) (“The district court in this case relied on *Brunette Machine Works,*
24 *Ltd. v. Kockum Industries, Inc.*, 406 U.S. 706, 706, 92 S.Ct. 1936, 32 L.Ed.2d
25 428 (1972), and § 1391(c)(3) to hold that...a foreign corporation[] is subject to suit in
26 any judicial district....We see no error in the district court’s analysis.”).



GENERAL BACKGROUND

12. This is an action for Patent Infringement of U.S. Patent 11,054,118 (“PLAINTIFF’S Patent”) under 35 U.S.C. § 271 based on each DEFENDANT’S unauthorized commercial using, offering for sale, and selling in and from the United States, and importing into the United States, each DEFENDANT’S lighting products, directly, indirectly, and/or by equivalence, and/or by the inducement of another.

13. PLAINTIFF designs and sells, in the United States and worldwide, their patented lighting fixtures (“PLAINTIFF’S lighting products”), which are sold through manufacturers and/or by contacting PLAINTIFF through their website: www.dsaent.com. A screenshot of PLAINTIFF’S website is provided as Exhibit 3.

14. PLAINTIFF’S decades of experience in the lighting industry, and his ingenuity, led him to invent the subject matter of PLAINTIFF’S PATENT.

15. PLAINTIFF’S PATENT claims priority to provisional patent application no.: 62/673,595, filed May 18, 2018.

16. PLAINTIFF’S PATENT has an earliest priority date of May 18, 2018, as indicated in Exhibit 34, which is a screenshot of Continuity Date for Patent Application 16/392,731 as provided by USPTO.gov.

17. PLAINTIFF’S PATENT was issued as a granted patent on July 6, 2021, naming David Sherman, officer of PLAINTIFF, as the inventor.

18. PLAINTIFF’S officer, David Sherman, also earned international patents in Canada (CA3040941) and China (CN202020617429.6). These international patents claim similar subject matter to the PLAINTIFF’S PATENT.

19. DEFENDANTS are individually infringing each and every claim PLAINTIFF’S PATENT. Claim mappings between DEFENDNATS’ infringing products and PLAINTIFF’S PATENT are provided in Tables 1-20 below.



1 **PLAINTIFF’S INITIAL MEETING WITH**
2 **LEDVANCE-PURCHASER: HOME DEPOT**

3 20. Upon information and belief, PLAINTIFF provided a first presentation to Home
4 Depot on or around April 2, 2019, after PLAINTIFF’S PATENT application was filed.
5 Content of this first presentation included descriptions of PLAINTIFF’S Patent. The
6 first slide of the first presentation is provided as Exhibit 8.

7 21. The first slide of the first presentation expressly indicated to Home Depot that
8 PLAINTIFF’S PATENT was pending at the time of the presentation.

9 22. Upon information and belief, PLAINTIFF provided a second presentation to
10 Home Depot on or around August 27, 2019. Content of the second presentation
11 included descriptions of the PLAINTIFF’s Patent. The first slide of the second
12 presentation is provided as Exhibit 9.

13 23. The first slide of the second presentation indicated to Home Depot that
14 PLAINTIFF’S Patent was pending at the time of the presentation.

15 24. Upon information and belief, and as provided in Exhibit 9, participants to the
16 presentations included product managers employed by Home Depot such as, but not
17 limited to “Craig Brown,” a former employee of Home Depot, and Cameron Skilling, a
18 buyer for Home Depot.

19 25. Home Depot is a buyer of LEDVANCE’S products, which are advertised under
20 the brand name “Sylvania”, as indicated in Exhibits 11 and 12.

21 **LEDVANCE’S PRODUCT LAUNCH AFTER**
22 **PRESENTATIONS FROM PLAINTIFF**

23 26. On or around May 17, 2023, LEDVANCE announced their “May 2023 Product
24 Launch” that included descriptions of LEDVANCE’S lighting products that infringe
25 PLAINTIFF’S PATENT. A screenshot of the announcement from YouTube.com is
26 found in Exhibit 14, which shows a snippet of a video available at the URL:

27 https://www.youtube.com/watch?v=EN6CcXA_QgU&t=1664s



1 27. The May 2023 Product Launch was also announced via a published PDF shown in
2 Exhibit 15, which was communicated to various lighting companies. The published
3 PDF includes additional descriptions of LEDVANCE’S lighting products that infringe
4 PLAINTIFF’S Patent.

5 28. PLAINTIFF’S counsel test purchased LEDVANCE’S product “LEDVANCE
6 Sylvania LEDMD/6R1200/ST9/SC3TW 6-in 14W LED Microdisk Downlight, 120V,
7 Selectable CCT,” on August 3, 2023.

8 29. PLAINTIFF’S counsel also test purchased LEDVANCE’S product “LEDVANCE
9 Sylvania LEDMD/4R800/ST9/SC3TW 4-in 10W LED TruWave Microdisk Downlight,
10 120V, Selectable CCT” on August 3, 2023.

11 30. LEDVANCE’S lighting product LEDMD/6R1200/ST9/SC3TW was purchased
12 from HomeElectrical at the following website URL, and as shown in Exhibit 19:

13 [https://www.homeelectrical.com/commercial-led-downlight/ledvance-sylvania-syl-
14 62882.1.html](https://www.homeelectrical.com/commercial-led-downlight/ledvance-sylvania-syl-62882.1.html)

15 31. LEDVANCE’S lighting product LEDMD/4R800/ST9/SC3TW was purchased
16 from HomeElectrical at the following website URL, and as shown in Exhibit 20:

17 [https://www.homeelectrical.com/commercial-led-downlight/ledvance-sylvania-syl-
18 62881.1.html](https://www.homeelectrical.com/commercial-led-downlight/ledvance-sylvania-syl-62881.1.html)

19 32. The products test purchased by PLAINTIFF’S counsel are shown in Tables 1-10
20 below.

21 33. LEDVANCE’S lighting products are “Made in China” and “[i]mported by”
22 LEDVANCE, as indicated on packaging of a test purchase of DEFENDANT’S lighting
23 products shown in Exhibit 16.

24 34. A front view of packaging of LEDVANCE’S lighting products is shown in
25 Exhibit 17.

26 35. A third party elemental analysis of a LEDVANCE’S infringing lighting product is
27 provided in Exhibit 18, which shows a screenshot of a report from the elemental
28



1 analysis. The report indicates that LEDVANCE’S lighting product (including the white
2 housing portions) includes metals such as, but not limited to, Sodium (Na), Magnesium,
3 Aluminum, Titanium, and Iron.

4 36. According to Bill of Ladings (MAEU229260456 / CHSL442021680SZN),
5 LEDVANCE receives shipments of products of H.S. Code 8539.49 (*e.g.*, LED Lamps)
6 from their subsidiary in China, LEDVANCE Lighting Co. Ltd., No. 1-1 Industrial Road
7 North Chancheng District Foshan PRC., China. (See, *e.g.*, Exhibit 21 at pgs. 32-33).

8 37. Additionally, and as shown in Exhibit 21, shipments of products of H.S. Code
9 8539.49 are received at LEDVANCE’S, “1651 South Archibald Avenue, United States”,
10 which matches the address of their distribution center in San Bernadino County at 1651
11 S Archibald Ave, Ontario, CA 91761 (see, *e.g.*, Exhibits 4-7).

12 38. On August 14, 2023, PLAINTIFF sent two cease and desist letters to two different
13 addresses for LEDVANCE via USPS Certified Mail. A first page of the cease and desist
14 letter is provided as Exhibit 52.

15 39. The cease and desist letters included a copy of the title page of PLAINTIFF’S
16 PATENT, images of LEDVANCE’S infringing products, and tables substantially similar
17 to Tables 1-10 provided below.

18 40. One of the two cease and desist letters were indicated as received by LEDVANCE
19 on August 21, 2023 in Wilmington, MA, according to USPS tracking data.

20 41. Upon information and belief, LEDVANCE did not provide PLAINTIFF a
21 response to any of the cease and desist letters.

22 42. Upon information and belief, LEDVANCE continued to willfully infringe
23 PLAINTIFF’S PATENT after receiving the cease and desist letters, in violation of 35
24 U.S.C. §§ 271 and 284.

25
26
27
28



PLAINTIFF'S INITIAL
MEETING WITH LOWE'S

1
2
3 43. Upon information and belief, and as provided in Exhibit 10, PLAINTIFF provided
4 a third presentation to the companies Lowe's and Rona (at the time, a subsidiary of
5 Lowe's), on or around January 15, 2020, and after PLAINTIFF'S PATENT application
6 was filed. Content of the third presentation included descriptions of PLAINTIFF'S
7 PATENT. Slides from the third presentation are provided as Exhibit 10, at pgs. 20-21 of
8 the Exhibits.

9 44. Upon information and belief, and as provided in Exhibit 10, participants to the
10 third presentation included buying staff employed by the companies Rona and Lowe's
11 such as, but not limited to, "Elaine Pellerin" and "Philippe Ciot."

12 45. Upon information and belief, Elaine Pellerin was also a chief procurement officer
13 in lighting for RONA, which was acquired by Lowes Companies, Inc. on or before May
14 2016, prior to PLAINTIFF'S presentation to Lowe's. See, *e.g.*, Exhibit 55 and Rona's
15 website: <https://www.ronainc.ca/en/news/lowes-completes-acquisition-of-rona>.

16 46. Upon information and belief, Philippe Ciot was a marketing specialist of Lowe's
17 Canada, a now-dissolved subsidiary of LOWE'S CHINA'S parent company, Lowes'
18 Companies, Inc. (See Articles of Dissolution in Exhibit 54 and Exhibit 56). Philippe
19 Ciot's LinkedIn profile (Exhibit 56) indicates they are still employed by Lowe's Canada,
20 despite Lowe's Canda being dissolved, therefore it is plausible that Philippe Ciot is
21 employed by DEFENDANT, Lowe's Companies, Inc., or another subsidiary of Lowe's
22 Companies, Inc. *Id.*

23 47. The third slide of the third presentation expressly indicated to the companies
24 Lowe's and Rona that PLAINTIFF'S PATENT was pending at the time of the
25 presentation. See Exhibit 10.



1 48. The purpose of the third presentation was to solicit Lowe’s (*i.e.*, an importer/buyer
2 subsidiary of Lowe’s such as LOWE’S CHINA) to order PLAINTIFF’s lighting
3 products from an authorized producer of PLAINTIFF’S lighting products.

4 49. The third presentation to the Lowe’s included *multiple* slides indicating
5 PLAINTIFF’S PATENT was pending at the time of the third presentation. See, *e.g.*,
6 Exhibit 10 at pg. 21, which is a slide from the third presentation and expressly provides a
7 Notice of “Patent Pending” above an image of a version of PLAINTIFF’S lighting
8 product.

9 50. Upon information and belief, LOWES CHINA’S parent company and subsidiaries
10 share, amongst themselves, some employees, managers, officers, and/or information.

11 51. For example, according to a translation of the corporate registration document for
12 LOWES CHINA in China, “David Ray Green” is the “Legal Representative” of
13 LOWES CHINA (see Exhibits 32 and 33, which include a foreign corporate registration
14 and a translation provided by a third party web application). David Ray Green is, in
15 summary, a common owner, manager, and/or legal officer to at least the following
16 Lowe’s entities:

- 17 (1) Lowe’s foreign subsidiary LOWE’S CHINA (see *Id.*),
- 18 (2) LOWE’S CHINA’S parent company Lowe’s Companies, Inc. (see Exhibit 49),
- 19 (3) Lowe’s Home Centers, LLC (see Exhibit 59), a Lowe’s subsidiary; and
- 20 (4) L G Sourcing, Inc. (Exhibit 48).

21 52. Upon information and belief, “Beth R MacDonald” is also common owner,
22 manager, and/or legal officer to all of the following Lowe’s entities:

- 23 (1) Lowe’s Home Centers, LLC (see Exhibit 59), a Lowe’s subsidiary;
- 24 (2) L G Sourcing, Inc. (see Exhibit 48);
- 25 (3) Lowe’s Home Centers (Canada) Inc., which was dissolved February 25, 2019
26 (see Articles of Dissolution provided in Exhibit 54, and as available from
27 the Government of Canada via <https://ised-isde.canada.ca/site/ised/en>)



1 53. Upon information and belief, LOWES CHINA was aware of PLAINTIFF'S
2 PATENT, during its pendency, as of the date of the third presentation to Lowe's or
3 shortly thereafter.

4 **LOWE'S IMPORTING OF INFRINGING PRODUCTS**

5 **AFTER MEETING WITH PLAINTIFF**

6 54. On April 14, 2021, PLAINTIFF received email communications ("the
7 Manufacturer Communications") from PLAINTIFF'S approved manufacturer indicating
8 that sales orders for PLAINTIFF'S lighting products ("3in1" "Downlights" of "4" and
9 "5/6 inch") have been received by PLAINTIFF'S approved manufacturer for.

10 55. The Manufacturer Communications included the sales orders, which, in the
11 ordinary course of business, expressly identified the receiving party for the ordered
12 products to be: *Lowe's*. Copies of just two of these sales orders are attached as Exhibit
13 25, at pgs. 42-43 ("the Sales Orders").

14 56. The Sales Orders have been edited in Exhibit 25 to highlight where "Lowe's" is
15 expressly identified. Upon information and belief, the Chinese characters surrounding
16 the word "Lowe's" translate to English as: "We are waiting for Lowe's to finalize the
17 needed amount."

18 57. The Sales Orders include a Notice that advises LOWES CHINA of the intellectual
19 property associated with PLAINTIFF'S lighting products.

20 58. As emphasized in Exhibit 25, and upon information and belief, the Chinese
21 characters highlighted below each table in the Sales Orders, and adjacent to item "2,"
22 translate to English as: "The product must satisfy the technical and intellectual property
23 rules of the country in which the product is being sold," and thereafter indicates that the
24 buyer is liable for any "intellectual property violations."

25 59. At least in view of these written intellectual property Notices being incorporated
26 into the multiple Sales Orders, and the third presentation provided to the LOWES
27 CHINA, PLAINTIFF asserts that LOWES CHINA'S pirating activities subsequent to
28



1 receiving these Notices amounts to Willful Patent Infringement in violation of 35 U.S.C.
2 § 284.

3 60. Upon information and belief, the LOWES CHINA canceled their orders for
4 PLAINTIFF'S "3in1" lighting products subsequent to PLAINTIFF'S approved
5 manufacturer providing the Sales Orders.

6 61. Lowe's provided their own version of translations of these two Sales Orders
7 ("LOWE'S CHINA'S translations"), which can be found in Case 3:23-cv-01335-CAB-
8 JLB, Doc. No. 14-3 at pg. 2-7. Pages from Lowe's translated Sales Orders are provided
9 as Exhibits 57 and 58.

10 62. Lowe's, through their sworn declaration, provided the above-identified versions of
11 the translations, and Lowe's own versions also confirm that "Lowe's" was the entity
12 requesting the products identified in the Sales Orders. See *Id.*, and Case 3:23-cv-01335-
13 CAB-JLB at Doc. No. 14-2, and Exhibits 57 and 58.

14 63. A page from Lowe's translations indicates that one of the sales orders was for a
15 bulk order of "4 inch frameless **3 in 1** downlight[s]" (emphasis added). See Exhibit 57.

16 64. Exhibit 57 and Exhibit 29 evidence correlations between LOWE'S CHINA's
17 Sales Orders and LOWE'S CHINA'S Item #5041631 Model #MQTL1181-
18 LED10K9027, and Item #5041633 Model #MQTL1181-LED10K9027.

19 65. For example, Lowe's webpage from Exhibit 29 provides a first product benefit as
20 "*One* recessed downlight, *three* ways to install," hence boasting the advantages of the "3
21 in 1" product from the Sales Order in Exhibit 57.

22 66. Other correlations include the dimension "4 inch", "5 adjustable white colors"
23 (*e.g.*, 2.7K, 3K, 3.5K, 4K, 5K from the Sales Orders), and the various parts included
24 with Sales Orders and LOWE'S CHINA'S infringing products.

25 67. Another page from Lowe's translations indicates that another one of the sales
26 orders was for a bulk order of "5/6 inch frameless **3 in 1** downlight" (italics added) is
27 provided as Exhibit 58.

28



1 68. Exhibit 58, and Exhibits 28 and 30, evidence correlations between
2 DEFENDANT’S Sales Orders and DEFENDANT’S Item #5041630 Model
3 #MQTL1183-LED12K9027, Item #5041632 Model #MQTL1182-LED12K9027, and
4 Item #5041634 Model #MQTL1182-LED12K9027.

5 69. For example, Lowe’s webpages from Exhibits 28 and 30 provide a first product
6 benefit as “*One* recessed downlight, *three* ways to install,” hence boasting the
7 advantages of the “*3 in 1*” product from the Sales Order in Exhibit 58.

8 70. Other correlations include the dimensions “5/6 inch”, “5 adjustable white colors”
9 (*e.g.*, 2.7K, 3K, 3.5K, 4K, 5K from the Sales Orders), and the various parts included
10 with Sales Orders and DEFENDANT’S infringing products.

11 71. Upon information and belief, the Sales Orders were facilitated in part by Lowe’s
12 Global Sourcing Shanghai Ltd. (“LOWE’S CHINA”), a Chinese subsidiary of LOWE’S
13 CHINA’S parent company Lowe’s Companies, Inc. See Exhibits 15 and 16, as further
14 discussed herein.

15 72. Upon information and belief, products purchased by DEFENDANT LOWE’S
16 CHINA are ultimately sold by Lowe’s Home Centers, LLC, which owns and/or manages
17 retails stores of LOWE’S CHINA’S parent company Lowe’s Companies, Inc. See, *e.g.*,
18 Case 3:23-cv-01335-CAB-JLB, Doc. No. 1 at pgs. 2-6 (S. D. Cal. 2023).

19 73. Upon information and belief, Lowe’s Home Centers, LLC sells PLAINTIFF’S
20 patented lighting products in violation of 35 U.S.C. § 271. See, *e.g.*, *Id.*

21 74. Upon information and belief, on or before September 5, 2022, LOWES CHINA
22 purchased, and then caused importation of, LOWES CHINA’S pirated lighting products
23 (*e.g.*, see Exhibits 26-30) into the US in violation of 35 U.S.C. § 271.

24 75. Exhibit 26 provides a screenshot of the Lowe’s website, via which a “Utilitech”
25 “Item #5041630 Model #MQTL1183-LED12K9027” can be purchased. The Exhibit 26
26 screenshot was captured on or before May 8, 2023.

27
28



1 76. Exhibit 27 provides a screenshot of Lowe’s website, via which a “Utilitech” “Item
2 #5041631 Model #MQTL1181-LED12K9027” can be purchased. The Exhibit 27
3 screenshot was captured on or before May 8, 2023.

4 77. Exhibit 28 provides a screenshot of Lowe’s website, via which a “Utilitech” “Item
5 #5041632 Model #MQTL1182-LED12K9027” can be purchased. The Exhibit 28
6 screenshot was captured on or before May 8, 2023.

7 78. Exhibit 29 provides a screenshot of Lowe’s website, via which a “Utilitech” “Item
8 #5041633 Model #MQTL1181-LED12K9027” can be purchased. The Exhibit 29
9 screenshot was captured on or before May 8, 2023.

10 79. Exhibit 30 provides a screenshot of Lowe’s website, via which a “Utilitech” “Item
11 #5041634 Model #MQTL1181-LED12K9027” can be purchased. The Exhibit 30
12 screenshot was captured on or before May 8, 2023.

13 80. Exhibit 31 provides a screenshot of the Lowe’s website, which indicates that a
14 customer published, on “September 5, 2022,” a question regarding the infringing product
15 (Item #5041634). Exhibit 31, therefore, provides evidence that the infringing products
16 have been sold and/or imported by LOWES CHINA since September 5, 2022 (if not
17 earlier). The Exhibit 31 screenshot was captured on or before May 8, 2023.

18 81. The LOWES CHINA, and/or a related Lowe’s subsidiary, utilizes the trademark
19 “Utilitech” with goods that include “electric lighting fixtures, names recessed cans and
20 trims,” as evidenced by the screenshot of the USPTO.gov website provided as Exhibit
21 36.

22 82. Exhibit 35 provides a screenshot of a website for the company Intertek, which, in
23 Intertek’s ordinary course of business, provides compliance and certification testing for
24 numerous products, including “Utilitech” products. The Exhibit 35 screenshot was
25 captured on or before May 8, 2023.

26 83. The Exhibit 35 screenshot indicates that the company “Zhejiang Yankon Group
27 Co., Ltd.” provides products under the trade name “Utilitech” and these products include
28



1 those having the “Model Nos. MQTL1181-LED10K...MQTL1182-LED12K...[and]
2 MQTL1183-LED12K.” These are the same model numbers provided in the screenshots
3 of the Lowes.com website, provided in Exhibits 26-30.

4 84. Exhibit 35 is provided to evidence collaboration between the LOWES CHINA
5 and Zhejiang Yankon Group Co. Ltd. to manufacture and sell the LOWES CHINA’S
6 infringing lighting products provided in Exhibits 26-30.

7 85. Upon information and belief, the LOWES CHINA directed, or otherwise caused,
8 Zhejiang Yankon Group Co. Ltd. to manufacture lighting products that infringe on
9 PLAINTIFF’S PATENT. Upon information and belief, this occurred subsequent to
10 LOWES CHINA canceling their orders for PLAINTIFF’S lighting products, and
11 subsequent to buying staff for LOWES CHINA engaging with PLAINTIFF during and
12 after the third presentation to Lowe’s.

13 86. According to public reports provided by Zhejiang Yankon Group Co., Ltd., “LG
14 SOURCING INC.” is an accounts receivable of Zhejiang Yankon Group Co., Ltd.. See
15 Exhibits 37 and 38, which are available at the following URL:

16 [http://www.sse.com.cn/disclosure/listedinfo/announcement/c/2014-04-
17 21/600261_2013_nzy.pdf](http://www.sse.com.cn/disclosure/listedinfo/announcement/c/2014-04-21/600261_2013_nzy.pdf)

18 87. According to publicly available data, LG Sourcing Inc. ships lighting products
19 into the US from China, via the Ports of Los Angeles and Long Beach. See Exhibits, 22,
20 23, and 24.

21 88. Upon information and belief, the “LG” of “LG Sourcing Inc.” stands for “Lowe’s
22 Global”, and LOWE’S CHINA is an agent of, or otherwise includes many of the same
23 officers, managers, goals, and/or sources of information as LG Sourcing Inc.

24 89. The public report provided in Exhibits 37 and 38 is, according to a translation by
25 the Google Translate browser extension, a “2021 Semi-Annual Report” provided by
26 Zhejiang Yankon Group Co., Ltd., which has subsidiaries all over the world, including
27 California (See Exhibit 39).

28



1 90. Upon information and belief, Kai Zhao is a current or former “Deputy General
2 Manager” of Zhejiang Yankon Group Co. Ltd. (See Exhibit 40 and Case No.: 5:16-cv-
3 02173-JFW-SP (C.D. Cal. 2016) (“Second Yankon Case”).

4 91. Upon information and belief, Kai Zhao gave sworn testimony that Zhejiang
5 Yankon Group Co. Ltd. “sells FOB China” and that Lowe’s therefore takes possession
6 of products at the “Ningbo” (*i.e.*, Ningpo) port. See, *e.g.*, Exhibit 40, and the Second
7 Yankon Case, Doc. No. 45 at pg. 2, lines, 5-6, 9-8, and 27-28. See also, *e.g.*, Exhibit 41
8 and Case No.: 5:14-cv-00881-JGB-SP (C.D. Cal. 2014) (“First Yankon Case”), Doc. No.
9 33-1 at pg. 7, lines 21-23.

10 92. According to further sworn testimony of Kai Zhao during the First Yankon Case,
11 the “Lowe’s Shanghai team, the Shanghai procurement department” were involved in
12 producing the Utilitech lighting fixture that was the subject of the First Yankon Case.
13 (See Exhibit 42 and the First Yankon Case, Doc. No. 33-1 at pg. 10, lines 21-25).

14 93. An image of the Lowe’s Shanghai team is provided in Exhibit 50, and a timeline
15 of growth of imports facilitated by Lowe’s is provided in Exhibit 51. The slides
16 provided in Exhibits 50 and 51 are from a slide presentation published on or around May
17 2012.

18 94. The referenced portion of the sworn testimony of Kai Zhao is attached as Exhibit
19 42, and the “Utilitech” lighting fixture from the First Yankon Case is shown in Exhibit
20 43.

21 95. Upon information and belief, the “Lowe’s Shanghai team” from Kai Zhao’s sworn
22 testimony refers to the DEFENDANT Lowe’s Global Sourcing (Shanghai) Trading Co.,
23 Ltd. (“LOWES CHINA”) (See Exhibits 42 and 50).

24 96. Upon information and belief, publicly available import data (see Exhibit 45)
25 indicates that Lowe’s imports “lamps and lighting fittings” from Zhejiang Yankon
26 Group Co. Ltd. from the Ningbo departure port in China (shown in Exhibit 44) to the
27 Long Beach port in the US. This is also supported by the testimony of Kai Zhao in
28



1 Exhibit 21, from the First Yankon Case. (See Case No.: 5:14-cv-00881-JGB-SP, Doc.
2 No. 33-1 at pg. 7, lines 15-23).

3 97. Exhibit 44 is included for context, to show locations for LOWE’S CHINA (on
4 “Taicang Road”), Zhejiang Yankon Group Co. Ltd. (on “Renmin West Road”), and the
5 Ningbo (*i.e.*, Ningpo) Port.

6 98. Upon information and belief, LOWES CHINA imported, through regular
7 shipments, at least 237 separate shipments of goods manufactured by Zhejiang Yankon
8 Group Co. Ltd. into the ports of Los Angeles and Long Beach during the years 2021 and
9 2022 (See Exhibit 45). Upon information and belief, LOWES CHINA also utilized the
10 ports of Los Angeles and Long Beach to regularly import products prior to 2021.

11 99. Upon information and belief, Zhejiang Yankon Group Co. Ltd. received samples
12 of PLAINTIFF'S patented lighting products from PLAINTIFF’S approved manufacturer
13 before PLAINTIFF received the Sales Orders.

14 100. Upon information and belief, LOWES CHINA solicited Zhejiang Yankon Group
15 Co. Ltd. to manufacture LOWES CHINA’s pirated lighting products, which are
16 expressly identified in Exhibit 35 as being manufactured by Zhejiang Yankon Group Co.
17 Ltd. in China and are “Utilitech” products.

18 101. Upon information and belief, LOWES CHINA purchased infringing products
19 from Zhejiang Yankon Group Co. Ltd., and/or via a third party broker from Zhejiang
20 Yankon Group Co. Ltd., in China and caused them to be imported into the US for retail
21 sale by Lowe’s, in violation of 35 U.S.C. § 271.

22 102. On May 9, 2023, PLAINTIFF sent LOWES CHINA’S parent company, Lowe’s
23 Companies, Inc., and Zhejiang Yankon Group Co. Ltd. cease and desist letters via USPS
24 Certified Mail.

25 103. The cease and desist letters included a copy of the title page of PLAINTIFF’S
26 PATENT, screenshots of the Lowe’s webpages where the infringing products are being
27 sold, and tables substantially similar to tables 11-20 below.

28



1 104. The cease and desist letters were received May 11-12, 2023, according to USPS
2 tracking data. A first page of the 26-page Lowe’s cease and desist letter is provided as
3 Exhibit 53.

4 105. On June 11, 2023, a representative for Zhejiang Yankon Group Co. Ltd.
5 (“Yankon”) provided an email indicating that Yankon provided the alleged infringing
6 products to Lowe’s. Representatives for Lowe’s were copied, by Yankon, on the email
7 message from Yankon to PLAINTIFF.

8 106. Upon information and belief, LOWES CHINA willfully continued to infringe
9 PLAINTIFF’S PATENT, in violation of 35 U.S.C. § 284, after their parent company,
10 their client Yankon, and their relative subsidiaries, received the cease and desist letters.

11
12 **PATENT INFRINGEMENT**

13 **BY LEDVANCE**

14 107. PLAINTIFF repeats and realleges paragraphs 1-106 of this Complaint, as if fully
15 set forth herein.

16 108. LEDVANCE is infringing each and every Claim (see Tables 1-10 below) of the
17 PLAINTIFF’s Patent, by LEDVANCE’S direct, indirect, and/or by equivalence, using,
18 selling, and offering for sale in and from the United States, and/or importing into the
19 United States, LEDVANCE’S lighting products, and/or by inducing such infringement.

20 109. PLAINTIFF’s Patent was duly and legally issued on July 6, 2021, and names
21 David Sherman as the inventor. Attached as Exhibit 1 is a true and correct copy of the
22 PLAINTIFF’s Patent.

23 110. PLAINTIFF’S Patent claims priority to provisional patent application no.:
24 62/673,595 filed May 18, 2018.

25 111. PLAINTIFF is the owner of the entire right, title, and interest in and to the validly
26 issued PLAINTIFF’s Patent, which was assigned to PLAINTIFF by an Assignment. A
27 copy of the Assignment is provided as Exhibit 2.



1 112. Tables 1-10 include images of LEDVANCE’S lighting products and instruction
2 manuals that are sold with LEDVANCE’S lighting products.

3 113. Table 1 below includes a mapping between elements of Claim 1 of PLAINTIFF’S
4 Patent and LEDVANCE’S lighting product ITEM: 62882 / Model No.:
5 LEDMD6R1200ST9SC3TW.

6 114. Table 2 below includes a mapping between elements of Claim 1 and
7 PLAINTIFF’S Patent and LEDVANCE’S lighting product ITEM: 62881 / Model No.:
8 LEDMD4R800ST9SC3TW.

9 115. Table 3 below includes a mapping between elements of Claim 2 of PLAINTIFF’S
10 Patent and LEDVANCE’S lighting product ITEM: 62881 / Model No.:
11 LEDMD4R800ST9SC3TW.

12 116. Table 4 below includes a mapping between elements of Claim 2 and
13 PLAINTIFF’S Patent and LEDVANCE’S lighting product ITEM: 62882 / Model No.:
14 LEDMD6R1200ST9SC3TW.

15 117. Table 5 below includes a mapping between elements of Claim 3 of PLAINTIFF’S
16 Patent and LEDVANCE’S lighting product ITEM: 62881 / Model No.:
17 LEDMD4R800ST9SC3TW.

18 118. Table 6 below includes a mapping between elements of Claim 3 and
19 PLAINTIFF’S Patent and LEDVANCE’S lighting product ITEM: 62882 / Model No.:
20 LEDMD6R1200ST9SC3TW.

21 119. Table 7 below includes a mapping between elements of Claim 4 of PLAINTIFF’S
22 Patent and LEDVANCE’S lighting product ITEM: 62881 / Model No.:
23 LEDMD4R800ST9SC3TW.

24 120. Table 8 below includes a mapping between elements of Claim 4 and
25 PLAINTIFF’S Patent and LEDVANCE’S lighting product ITEM: 62882 / Model No.:
26 LEDMD6R1200ST9SC3TW.

27

28



1 121. Table 9 below includes a mapping between elements of Claim 5 of PLAINTIFF’S
 2 Patent and LEDVANCE’S lighting product ITEM: 62881 / Model No.:
 3 LEDMD4R800ST9SC3TW.

4 122. Table 10 below includes a mapping between elements of Claim 5 and
 5 PLAINTIFF’S Patent and LEDVANCE’S lighting product ITEM: 62882 / Model No.:
 6 LEDMD6R1200ST9SC3TW.

7 123. TABLE 1:

<p>8 <u>Claim 1 from PLAINTIFF’S Patent</u></p> <p>9</p> <p>10</p> <p>11</p>	<p>Images of product and manual from Sylvania and LEDVANCE: ITEM: 62882 / Model No.: LEDMD6R1200ST9SC3TW</p>
<p>12</p> <p>13 1. An apparatus to detachably attach an 14 LED light fixture to at least one of a 15 ceiling, and a recessed lighting fixture 16 housing, the apparatus comprises:</p>	<p>See Attached Images.</p>



1 a plurality of retrofit clips (102) adaptable
2 to attach with a body of the LED light
3 fixture by screwing them into a plurality of
4 screw holes (110);
5
6
7
8
9
10
11

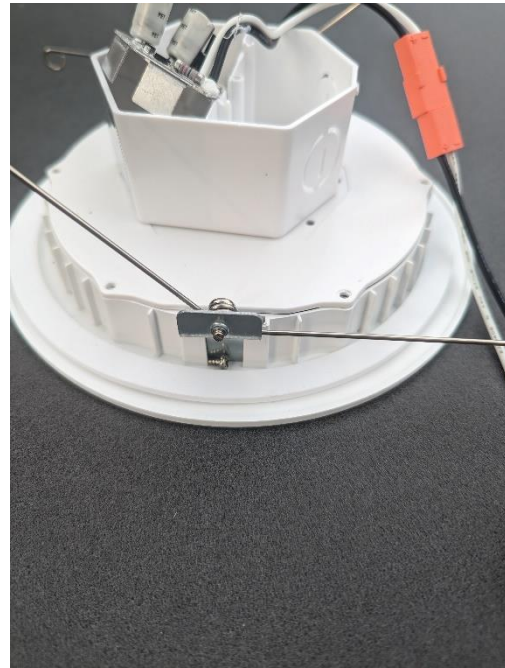

12 a plurality of new construction clips (104);
13
14
15
16
17
18
19
20
21
22
23



1 a plurality of connecting posts (106) to
2 hold the new construction clips (104);
3



4
5
6
7
8
9
10
11
12 a metal housing (108) to embody a
13 complete fixture (112);
14

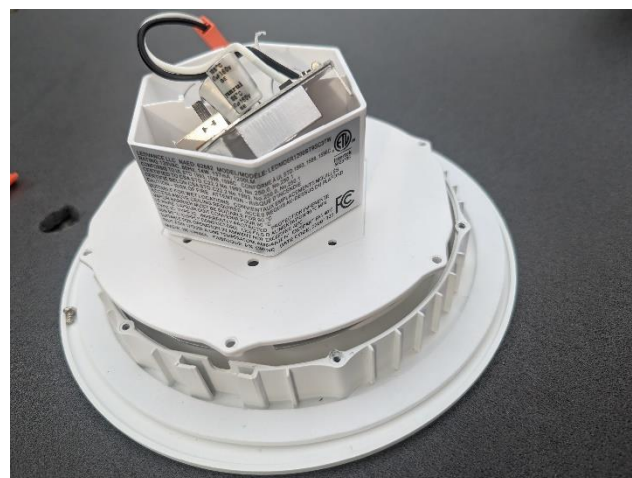

15
16
17
18
19
20 See Exhibit 18 for elemental analysis that
21 indicates metals including, but not limited
22 to, Sodium (Na), Magnesium, Aluminum,
23 Titanium, and Iron, are embodied in the
24 housing (including the white portions).
25



1 a junction box (116) to hold a plurality of
2 connection wirings, wherein the junction
3 box (116) comprises a plurality of output
4 wires; and
5
6
7
8
9
10



11
12
13
14
15
16
17
18
19
20
21
22
23
24
25
26
27
28

1 a twist connector (118) to attach the output
2 wires of the junction box (116) to the
3 metal housing (108),
4
5
6
7
8
9
10
11
12
13
14
15
16
17
18
19
20
21
22
23

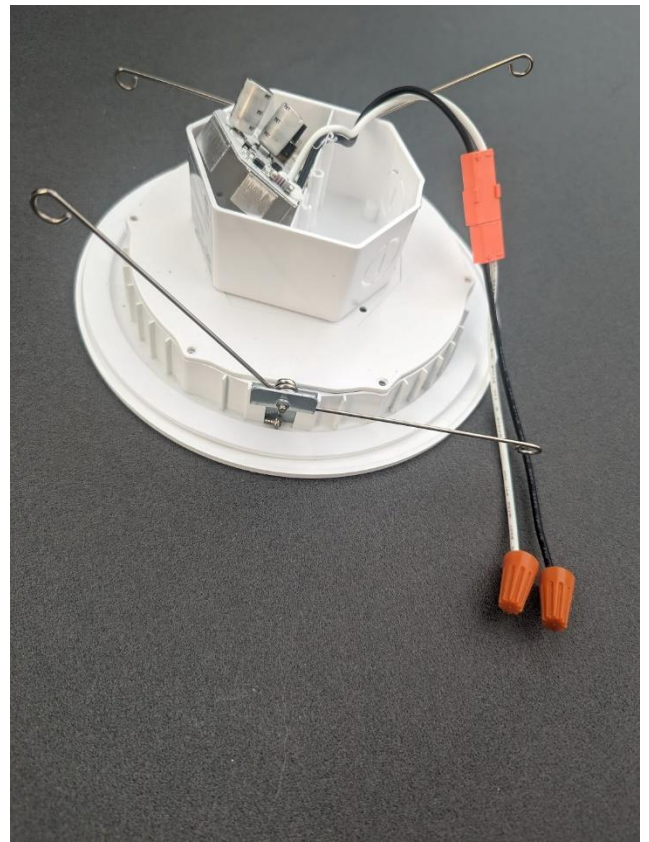
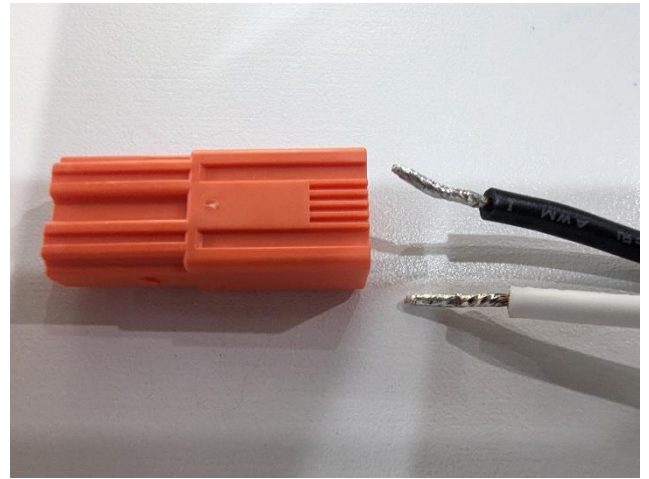

1
2
3
4
5
6
7
8
9
10
11
12
13
14
15
16
17
18
19
20
21
22
23
24
25
26
27
28



5. Install the E26 adapter into the CAN socket

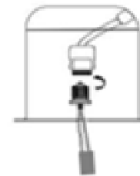

6. Connect the two-orange connector and gently push the fixture into the recesses CAN.

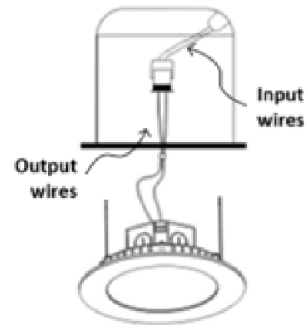

1 wherein the retrofit clips (102) make a
2 friction fit inside the recessed lighting
3 fixture housing to secure the complete
4 fixture (112) inside,
5
6
7
8
9

5. Install the E26 adapter into the CAN socket

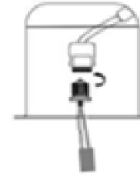

6. Connect the two-orange connector and gently push the fixture into the recesses CAN.

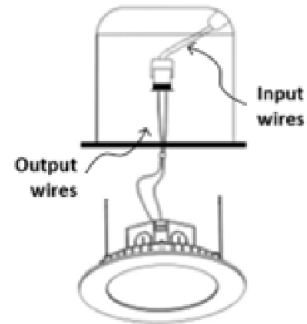

(text added to indicate input and output wires)

15 wherein the new construction clips (104)
16 are attached to the connecting posts (106)
17 if the recessed lighting fixture housing is
18 not present.
19
20
21
22
23
24

9. Pull the spring clips on the slim microdisk up and gently guide through the ceiling hole until the clips snap.

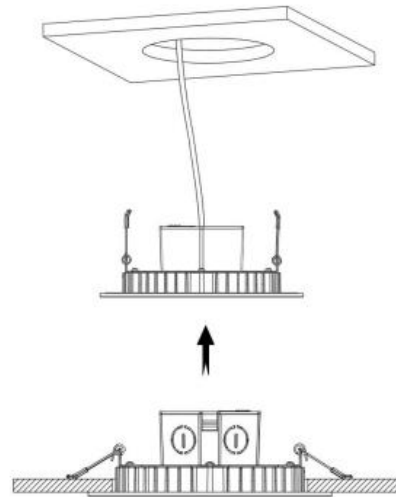

124.

TABLE 2:

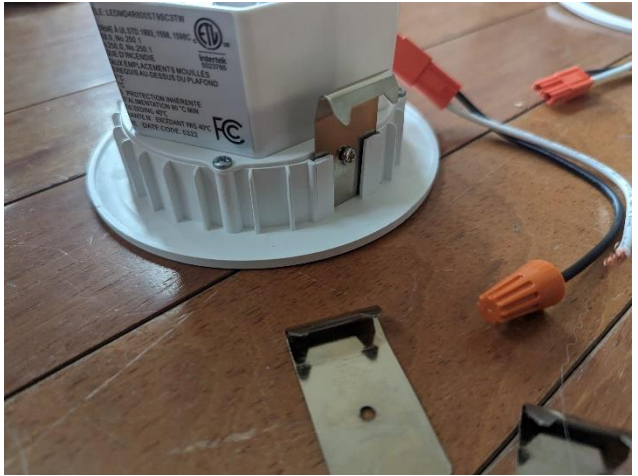
<p><u>Claim 1 from the PLAINTIFF's Patent</u></p>	<p>Images of product and manual from Sylvania and LEDVANCE: ITEM: 62881 / Model No.: LEDMD4R800ST9SC3TW</p>
<p>1. An apparatus to detachably attach an LED light fixture to at least one of a ceiling, and a recessed lighting fixture housing, the apparatus comprises:</p>	<p>See Attached Images.</p>
<p>a plurality of retrofit clips (102) adaptable to attach with a body of the LED light fixture by screwing them into a plurality of screw holes (110);</p>	



1 a plurality of new construction clips (104);
2
3
4
5
6
7
8
9
10
11
12
13
14



1 a plurality of connecting posts (106) to
2 hold the new construction clips (104);
3
4
5
6
7
8
9
10
11
12
13
14



15
16
17
18
19
20
21
22
23
24
25
26
27
28

1 a metal housing (108) to embody a
2 complete fixture (112);
3
4
5
6
7
8
9
10
11
12
13
14
15
16
17
18
19
20



21
22
23
24
25
26
27
28
See Exhibit 18 for elemental analysis that indicates metals including, but not limited to, Sodium (Na), Magnesium, Aluminum, Titanium, and Iron, are embodied in the housing (including the white portions).



1 a junction box (116) to hold a plurality of
2 connection wirings, wherein the junction
3 box (116) comprises a plurality of output
4 wires; and
5
6
7
8
9
10
11
12
13
14



15
16
17
18
19
20
21
22
23
24
25
26
27
28

1 a twist connector (118) to attach the output
2 wires of the junction box (116) to the
3 metal housing (108),
4
5
6
7
8
9
10
11
12
13
14
15
16
17
18
19
20
21
22
23
24
25
26
27
28

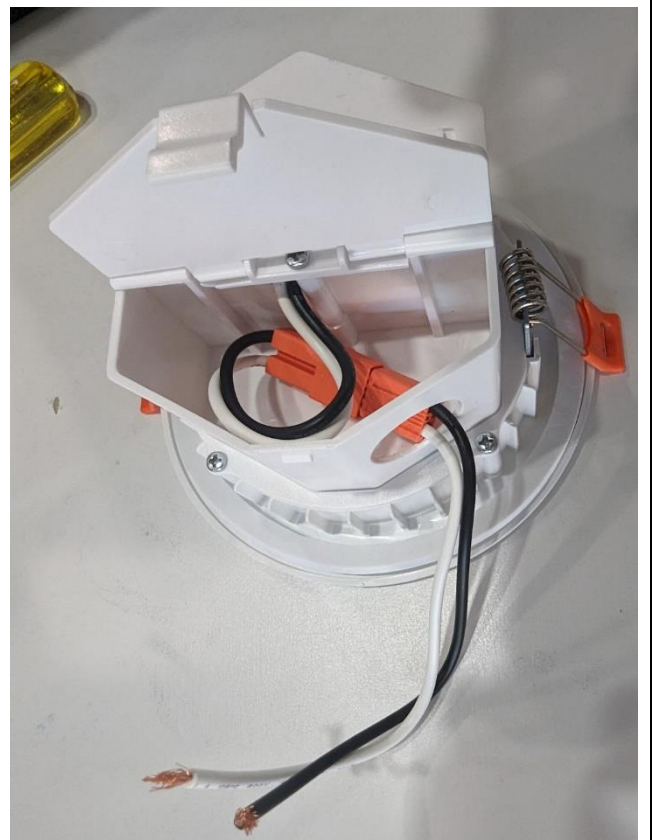
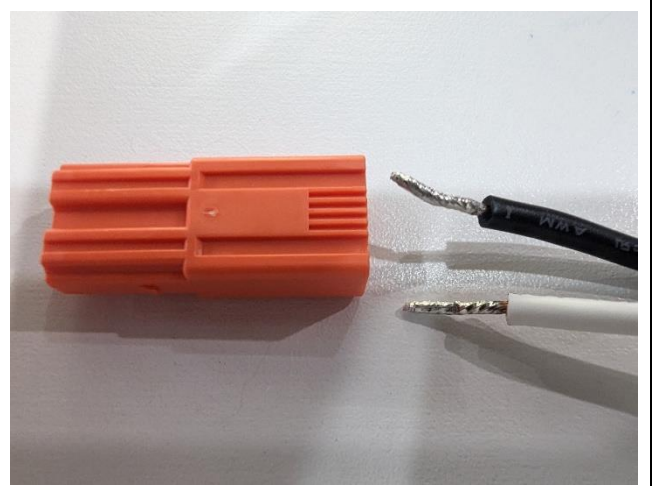

1
2
3
4
5
6
7
8
9
10
11
12
13
14
15
16
17
18
19
20
21
22
23
24
25
26
27
28

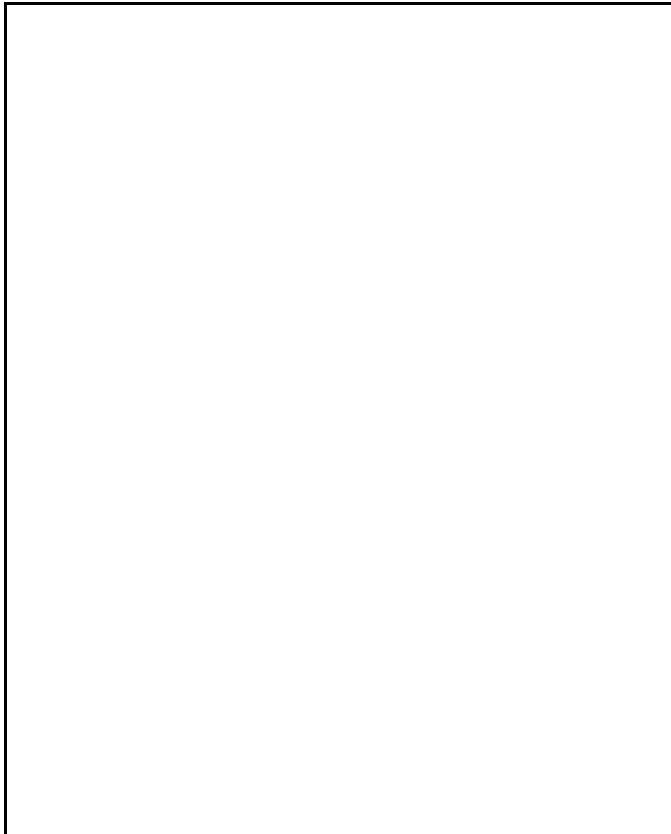

5. Install the E26 adapter into the CAN socket

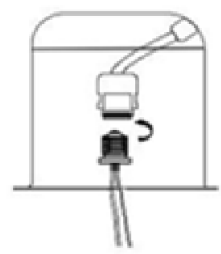

6. Connect the two-orange connector and gently push the fixture into the recesses CAN.

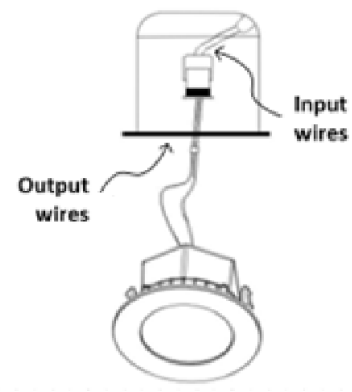

wherein the retrofit clips (102) make a friction fit inside the recessed lighting fixture housing to secure the complete fixture (112) inside,

5. Install the E26 adapter into the CAN socket

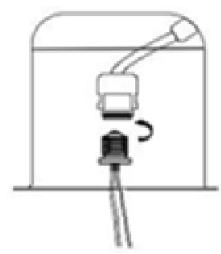

6. Connect the two-orange connector and gently push the fixture into the recesses CAN.

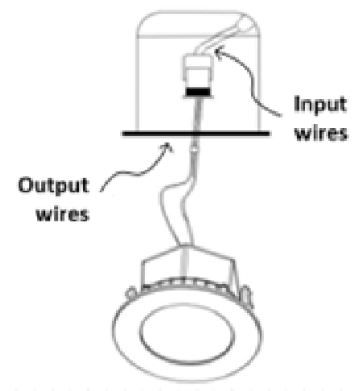

1
2
3
4
5
6
7
8
9
10
11
12
13
14
15
16
17
18
19
20
21
22
23
24
25
26
27
28

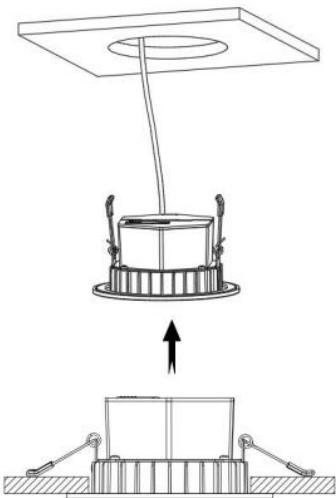
	<p><i>(text added to indicate input and output wires)</i></p>
<p>wherein the new construction clips (104) are attached to the connecting posts (106) if the recessed lighting fixture housing is not present.</p>	<p>9. Pull the spring clips on the slim microdisk up and gently guide through the ceiling hole until the clips snap.</p> 

1 125.

TABLE 3:

<p>2 <u>Claim 2 from PLAINTIFF's Patent</u></p> <p>3</p> <p>4</p> <p>5</p> <p>6</p>	<p>Images of product and manual from Sylvania and LEDVANCE: ITEM: 62881 / Model No.: LEDMD4R800ST9SC3TW</p>
<p>7 2. The apparatus according to claim 1</p> <p>8 comprises a socket adapter (114) to</p> <p>9 replace a light bulb in the recessed lighting</p> <p>10 fixture housing.</p> <p>11</p> <p>12</p> <p>13</p> <p>14</p> <p>15</p> <p>16</p> <p>17</p> <p>18</p> <p>19</p> <p>20</p> <p>21</p>	



1 126.

TABLE 4:

<p>2 <u>Claim 2 from PLAINTIFF's Patent</u></p> <p>3</p> <p>4</p> <p>5</p> <p>6</p>	<p>Images of product and manual from Sylvania and LEDVANCE: ITEM: 62882 / Model No.: LEDMD6R1200ST9SC3TW</p>
<p>7 2. The apparatus according to claim 1</p> <p>8 comprises a socket adapter (114) to</p> <p>9 replace a light bulb in the recessed lighting</p> <p>10 fixture housing.</p> <p>11</p> <p>12</p> <p>13</p> <p>14</p> <p>15</p> <p>16</p> <p>17</p> <p>18</p> <p>19</p> <p>20</p>	



1 127.

TABLE 5:

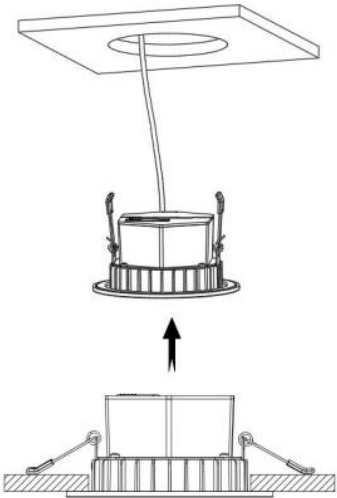
<p>2 <u>Claim 3 from PLAINTIFF's Patent</u></p> <p>3</p> <p>4</p> <p>5</p> <p>6</p>	<p>Images of product and manual from Sylvania and LEDVANCE: ITEM: 62881 / Model No.: LEDMD4R800ST9SC3TW</p>
<p>7 3. The apparatus according to claim 1, 8 wherein the new construction clips (104) 9 squeeze ceiling material placed between 10 the new construction clips (104) and an 11 extremity of the metal housing (108).</p> <p>12</p> <p>13</p> <p>14</p> <p>15</p> <p>16</p> <p>17</p>	<p>9. Pull the spring clips on the slim microdisk up and gently guide through the ceiling hole until the clips snap.</p> 



128.

TABLE 6:

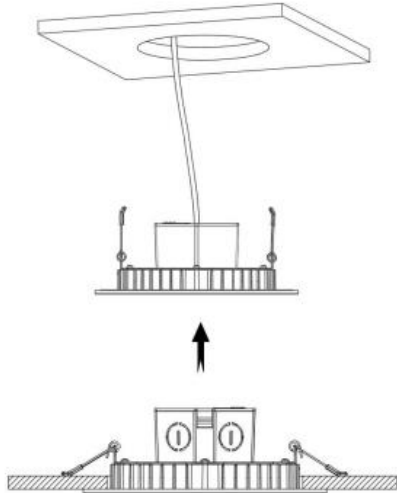
<p><u>Claim 3 from PLAINTIFF's Patent</u></p>	<p>Images of product and manual from Sylvania and LEDVANCE: ITEM: 62882 / Model No.: LEDMD6R1200ST9SC3TW</p>
<p>3. The apparatus according to claim 1, wherein the new construction clips (104) squeeze ceiling material placed between the new construction clips (104) and an extremity of the metal housing (108).</p>	<p>9. Pull the spring clips on the slim microdisk up and gently guide through the ceiling hole until the clips snap.</p> 

1
2
3
4
5
6
7
8
9
10
11
12
13
14
15
16
17
18
19
20
21
22
23
24
25
26
27
28

129. TABLE 7:

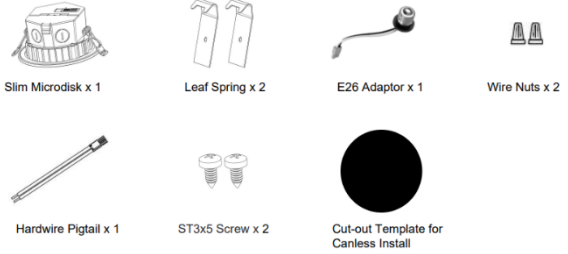
<p><u>Claim 4 from PLAINTIFF's Patent</u></p>	<p>Images of product and manual from Sylvania and LEDVANCE: ITEM: 62881 / Model No.: LEDMD4R800ST9SC3TW</p>
<p>4. The apparatus according to claim 1, wherein the complete fixture (112) comprises a plurality electrical systems, clips, and accessories.</p>	<p>HARDWARE INCLUDED</p>  <p>Slim Microdisk x 1 Leaf Spring x 2 E26 Adaptor x 1 Wire Nuts x 2 Hardwire Pigtail x 1 ST3x5 Screw x 2 Cut-out Template for Canless Install</p>

130. TABLE 8:

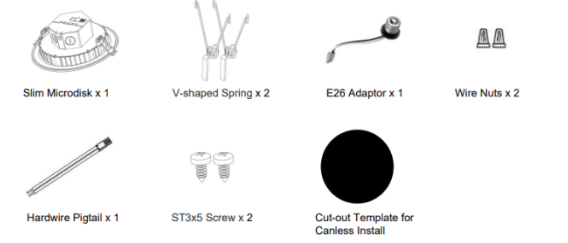
<p><u>Claim 4 from PLAINTIFF's Patent</u></p>	<p>Images of product and manual from Sylvania and LEDVANCE: ITEM: 62882 / Model No.: LEDMD6R1200ST9SC3TW</p>
<p>4. The apparatus according to claim 1, wherein the complete fixture (112) comprises a plurality electrical systems, clips, and accessories.</p>	<p>HARDWARE INCLUDED</p>  <p>Slim Microdisk x 1 V-shaped Spring x 2 E26 Adaptor x 1 Wire Nuts x 2 Hardwire Pigtail x 1 ST3x5 Screw x 2 Cut-out Template for Canless Install</p>



1 131.

TABLE 9:

<p>2 <u>Claim 5 from PLAINTIFF's Patent</u></p> <p>3</p> <p>4</p> <p>5</p> <p>6</p>	<p>Images of product and manual from Sylvania and LEDVANCE: ITEM: 62881 / Model No.: LEDMD4R800ST9SC3TW</p>
<p>7 5. The apparatus according to claim 1, 8 wherein the junction box (116) allows an 9 LED driver to be installed and comprises a 10 predefined area to attach a plurality of 11 wires.</p> <p>12</p> <p>13</p> <p>14</p> <p>15</p> <p>16</p> <p>17</p> <p>18</p> <p>19</p> <p>20</p> <p>21</p>	



1
2
3
4
5
6
7
8
9
10
11
12
13
14
15
16
17
18
19
20
21
22
23
24
25
26
27
28

132.

TABLE 10:

<p><u>Claim 5 from PLAINTIFF’s Patent</u></p>	<p>Images of product and manual from Sylvania and LEDVANCE: ITEM: 62882 / Model No.: LEDMD6R1200ST9SC3TW</p>
<p>5. The apparatus according to claim 1, wherein the junction box (116) allows an LED driver to be installed and comprises a predefined area to attach a plurality of wires.</p>	

1 133. Upon information and belief, LEDVANCE have not stopped engaging in their
2 willful and reckless infringing activities.

3 134. Upon information and belief, LEDVANCE have infringed, directly, indirectly,
4 and/or by equivalents, the PLAINTIFF's Patent by using, selling, and offering for sale
5 LEDVANCE'S lighting products from the United States, and importing into the United
6 States, LEDVANCE'S lighting products that embody each and every claim element of
7 each respective claim of the PLAINTIFF's Patent.

8 135. Upon information and belief, LEDVANCE has known of the existence of the
9 PLAINTIFF's Patent, and their egregious acts of infringement have been willful and in
10 reckless disregard for the PLAINTIFF's rights per the PLAINTIFF's PATENT, without
11 any basis for believing that LEDVANCE had a right to engage in the infringing conduct.

12 136. PLAINTIFF has sustained, and is likely to continue sustaining, actual damages
13 due to LEDVANCE'S activities, including lost sales and reduced market share resulting
14 from LEDVANCE'S infringing conduct.

15 137. Unless enjoined by this Court, LEDVANCE will continue to infringe the
16 PLAINTIFF's Patent and cause PLAINTIFF to suffer irreparable harm for which there is
17 no adequate remedy at law. PLAINTIFF is thus entitled to an injunction against
18 LEDVANCE.

19
20 **PATENT INFRINGEMENT**

21 **BY LOWES CHINA**

22 138. PLAINTIFF repeats and realleges paragraphs 1-137 of this Complaint, as if fully
23 set forth herein.

24 139. LOWES CHINA is infringing each and every Claim (see Tables 11-20 below) of
25 the PLAINTIFF's Patent, by LOWES CHINA'S direct, indirect, and/or by equivalence,
26 using, selling, and offering for sale in and from the United States, and/or importing into
27
28



1 the United States, LOWES CHINA’S lighting products, and/or by inducing such
 2 infringement.

3 140. Tables 11-20 include images of LOWES CHINA’S lighting products and
 4 instruction manuals that are sold with LOWES CHINA’S lighting products.

5 141. TABLE 11 below provides a Claim mapping of Claim 1 from PLAINTIFF’S
 6 PATENT, and illustrates examples of how LOWES CHINA’S products (*e.g.*, Item
 7 #5041631 and Item #5041633) infringe at least Claim 1 of PLAINTIFF’S PATENT.

8 142. Images in the right column of Table 11 include photographs of: products
 9 purchased directly from the LOWES CHINA’S, and screenshots of an instruction
 10 manual available through the Lowe’s website (*e.g.*, Scroll to “Overview” and select
 11 “Manual PDF” at <https://www.lowes.com/pd/Utilitech/5013345333>).

12
 13 143. TABLE 11:

<p>14 <u>Claim 1 from DSAE Patent</u></p>	<p>15 Images of product and manual for 16 Lowe’s: 17 Item #5041631 Model #MQTL1181- 18 LED10K9027, and 19 Item #5041633 Model #MQTL1181- 20 LED10K9027</p>
<p>21 1. An apparatus to detachably attach an 22 LED light fixture to at least one of a 23 ceiling, and a recessed lighting fixture 24 housing, the apparatus comprises:</p>	<p>25 See Attached Images.</p>



1 a plurality of retrofit clips (102) adaptable
2 to attach with a body of the LED light
3 fixture by screwing them into a plurality of
4 screw holes (110);
5
6
7
8
9
10
11
12
13
14
15
16

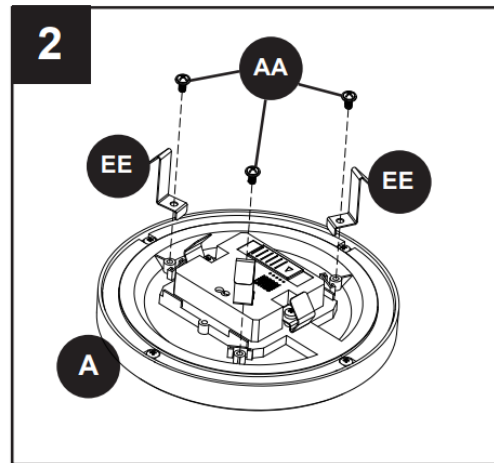
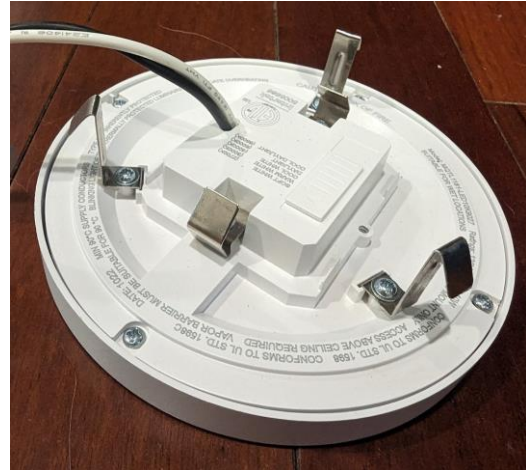

17 a plurality of new construction clips (104);
18
19
20
21
22
23
24
25
26
27
28

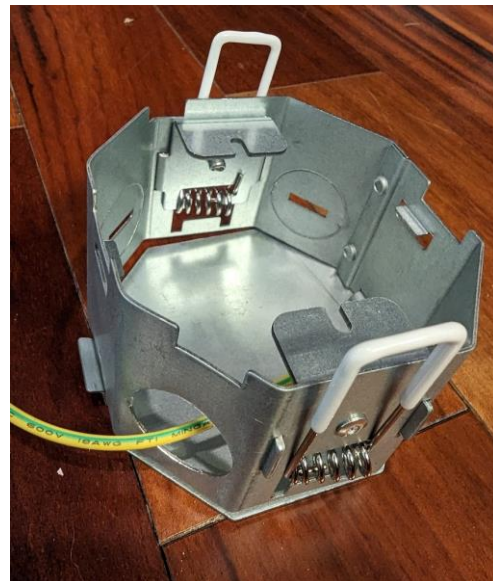

1
2
3
4
5
6
7
8
9
10
11
12
13
14
15
16
17
18
19
20
21
22
23
24
25
26
27
28

a plurality of connecting posts (106) to hold the new construction clips (104);



a metal housing (108) to embody a complete fixture (112);



1
2
3
4
5
6
7
8
9
10
11
12
13
14
15
16
17
18
19
20
21
22
23
24
25
26
27
28

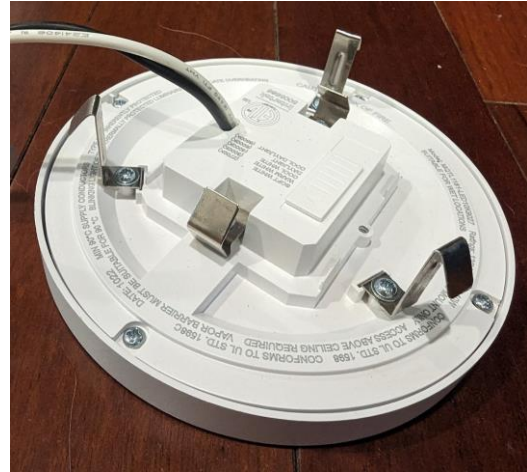

Elemental analysis indicates portions of the housing (including the white portions) include metals such as, but not limited to: Sodium, Magnesium, Aluminum, Titanium, and Iron. (See Exhibit 47).

a junction box (116) to hold a plurality of connection wirings, wherein the junction box (116) comprises a plurality of output wires; and



1
2
3
4
5
6
7
8
9
10
11
12
13
14
15
16
17
18
19
20
21
22
23
24
25
26
27
28

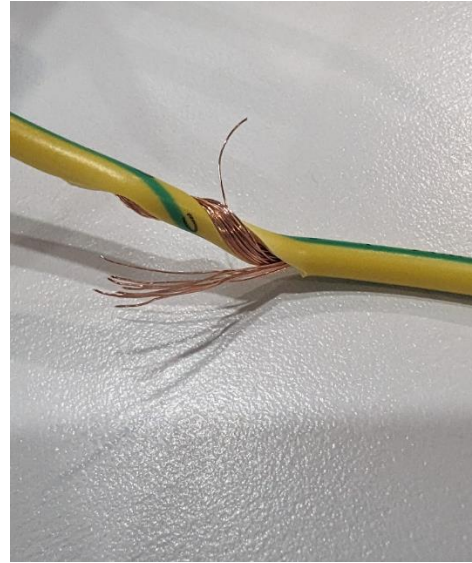

(green/yellow wire partially stripped of insulation to show wires)

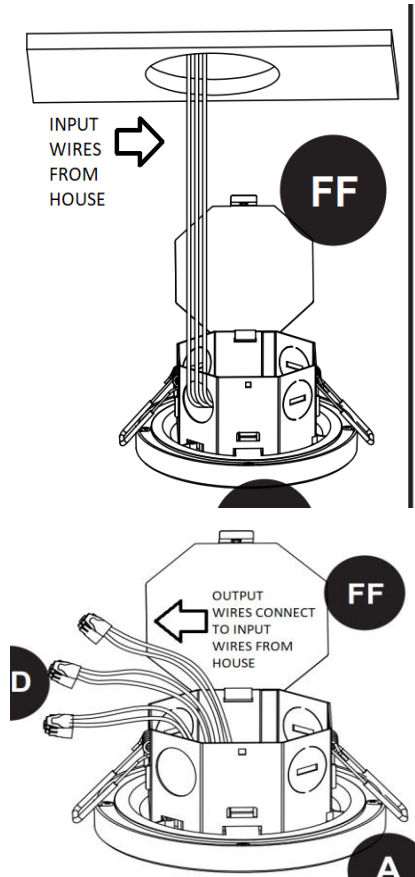

(Some text and arrows added for context)

1
2
3
4
5
6
7
8
9
10
11
12
13
14
15
16
17
18
19
20
21
22
23
24
25
26
27
28

(e.g., the green and yellow insulation surrounds a plurality of wires; the white insulation surrounds a plurality of other wires; the black insulation surrounds a plurality of additional wires)

a twist connector (118) to attach the output wires of the junction box (116) to the metal housing (108),



(e.g., when a consumer/user initially

1
2
3
4
5
6
7
8
9
10
11
12
13
14
15
16
17
18
19
20
21
22
23
24
25
26
27
28

opens the product box, each plurality of wires extending from their respective white, black, or green/yellow insulations is already twisted and inserted into their respective orange twist connector. A plurality of wires was removed from a twist connector for capturing the above-image to reveal the twisted and coated plurality of wires.)

wherein the retrofit clips (102) make a friction fit inside the recessed lighting fixture housing to secure the complete fixture (112) inside,

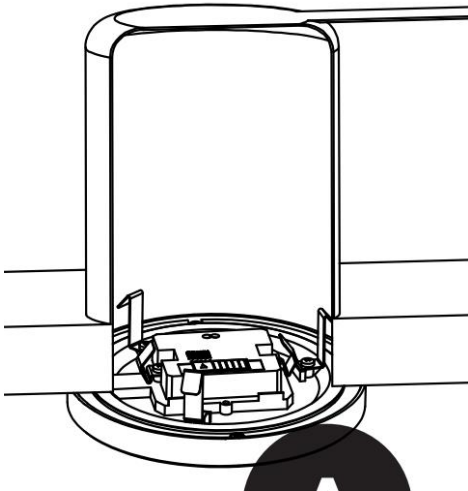

wherein the new construction clips (104) are attached to the connecting posts (106) if the recessed lighting fixture housing is not present.

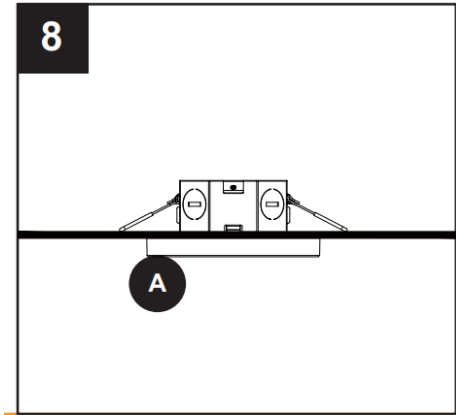

1
2
3
4
5
6
7
8
9
10
11
12
13
14
15
16
17
18
19
20
21
22
23
24
25
26
27
28

	<p>From Lowe’s website:</p> <p>“<i>One</i> recessed downlight, <i>three</i> ways to install! The versatile <i>3 in 1</i> recessed downlight comes with everything you need to either hardwire to existing ceiling j-box, direct wire to the fixture with attachable integrated j-box, or install in existing can with the E26 screw in base.”</p> <p>See: https://www.lowes.com/pd/Utilitech/5013345333 (emphasis added)</p>
--	-------------------------------------------------------------------------------------------------------------------------------------------------------------------------------------------------------------------------------------------------------------------------------------------------------------------------------------------------------------------------------------------------------------------------------------------------------------------------------------------------------------------

144. TABLE 12 below provides a Claim mapping of Claim 1 from PLAINTIFF’S PATENT, and illustrates examples of how LOWES CHINA’S products (*e.g.*, Item #5041630, Item #5041632, and Item #5041634) infringe at least Claim 1 of PLAINTIFF’S PATENT.

145. Images in the right column of Table 12 include photographs of: products purchased directly from LOWES CHINA, and screenshots of an instruction manual available through the Lowe’s website (*e.g.*, Scroll to “Overview” and select “Manual PDF” at [https://www.lowes.com/pd/ Utilitech-UT-5-or-6-IN-CCT-3-1-UNIV-DL-6-Ct-White-5-in-or-6-in-800-Lumen-Cool-White-Round-Dimmable-Recessed-Downlight-6-Pack/5013469735](https://www.lowes.com/pd/Utilitech-UT-5-or-6-IN-CCT-3-1-UNIV-DL-6-Ct-White-5-in-or-6-in-800-Lumen-Cool-White-Round-Dimmable-Recessed-Downlight-6-Pack/5013469735)).

1 146.

TABLE 12:

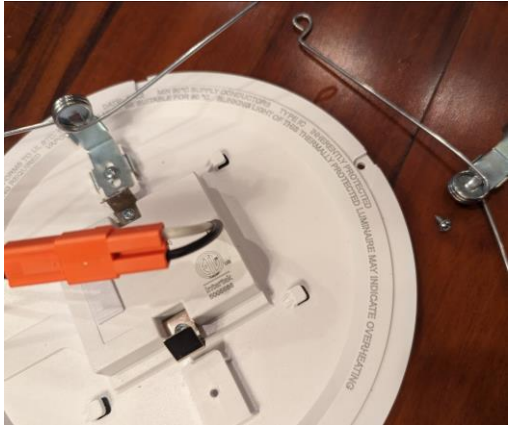
<p>2 <u>Claim 1 from PLAINTIFF’S PATENT</u></p> <p>3</p> <p>4</p> <p>5</p> <p>6</p> <p>7</p> <p>8</p> <p>9</p> <p>10</p> <p>11</p>	<p>Images from product and manual for Lowe’s:</p> <p>Item #5041630 Model #MQTL1183-LED12K9027</p> <p>Item #5041632 Model #MQTL1182-LED12K9027</p> <p>Item #5041634 Model #MQTL1182-LED12K9027</p>
<p>12 1. An apparatus to detachably attach an</p> <p>13 LED light fixture to at least one of a</p> <p>14 ceiling, and a recessed lighting fixture</p> <p>15 housing, the apparatus comprises:</p>	<p>See Attached Images.</p>
<p>16 a plurality of retrofit clips (102) adaptable</p> <p>17 to attach with a body of the LED light</p> <p>18 fixture by screwing them into a plurality of</p> <p>19 screw holes (110);</p> <p>20</p> <p>21</p> <p>22</p> <p>23</p>	



1
2
3
4
5
6
7
8
9
10
11
12
13
14
15
16
17
18
19
20
21
22
23
24
25
26
27
28

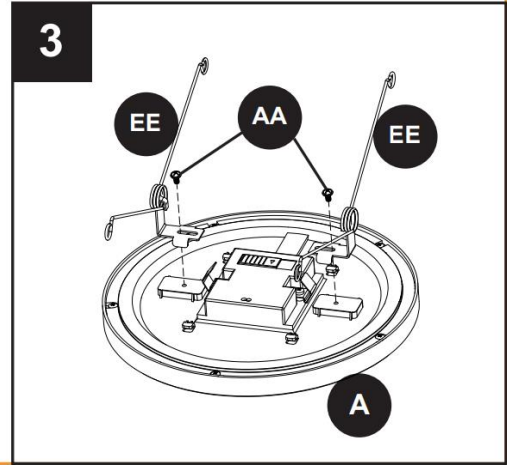

a plurality of new construction clips (104);



a plurality of connecting posts (106) to hold the new construction clips (104);

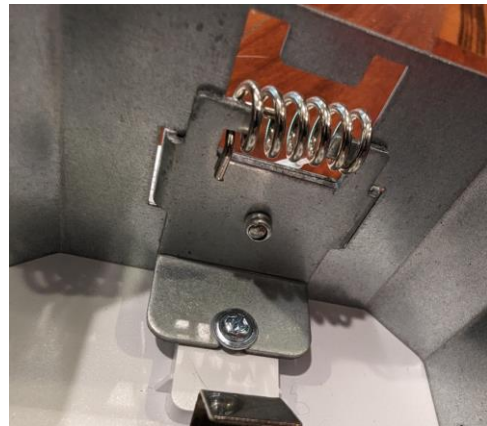

1 a metal housing (108) to embody a
2 complete fixture (112);
3
4
5
6
7
8
9
10
11
12
13
14
15
16
17
18
19
20
21
22
23
24
25
26
27
28

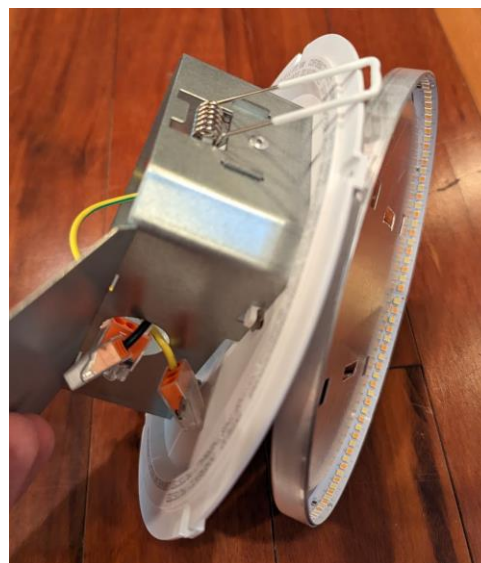

Elemental analysis indicates portions of the housing (including the white portions) include metals such as, but not limited to: Sodium, Magnesium, Aluminum, Titanium, and Iron. (See Exhibit 47).



1 a junction box (116) to hold a plurality of
2 connection wirings, wherein the junction
3 box (116) comprises a plurality of output
4 wires; and
5
6
7
8
9
10
11
12
13
14
15
16
17
18
19
20
21

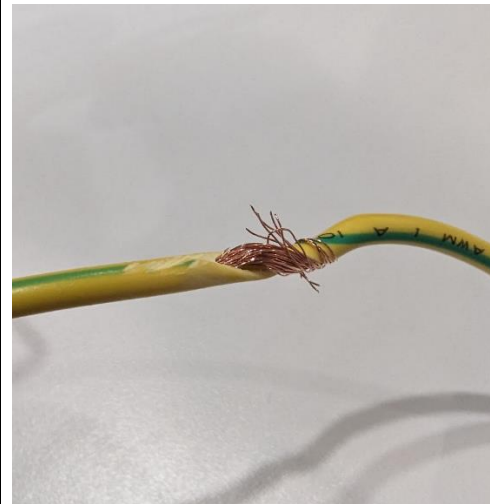
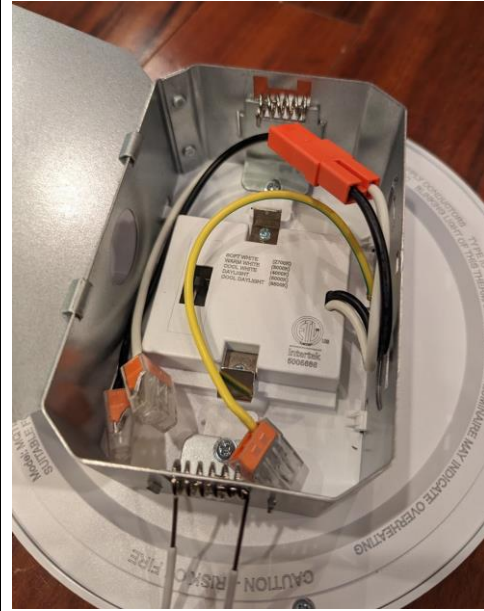

(green/yellow wire partially stripped of insulation to show wires)



1
2
3
4
5
6
7
8
9
10
11
12
13
14
15
16
17
18
19
20
21
22
23
24
25
26
27
28

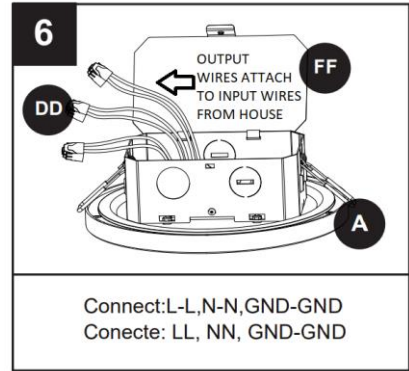
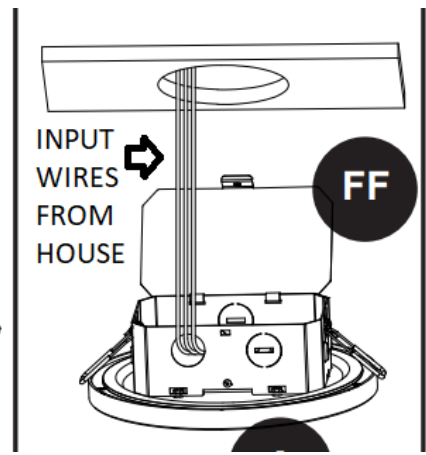

(Some text and arrows added for context.)

(e.g., the green and yellow insulation surrounds a plurality of wires; the white insulation surrounds a plurality of other wires; the black insulation surrounds a plurality of additional wires)

1 a twist connector (118) to attach the output
2 wires of the junction box (116) to the
3 metal housing (108),
4
5
6
7
8
9
10
11
12
13
14
15
16
17
18
19
20
21
22
23
24
25
26
27
28

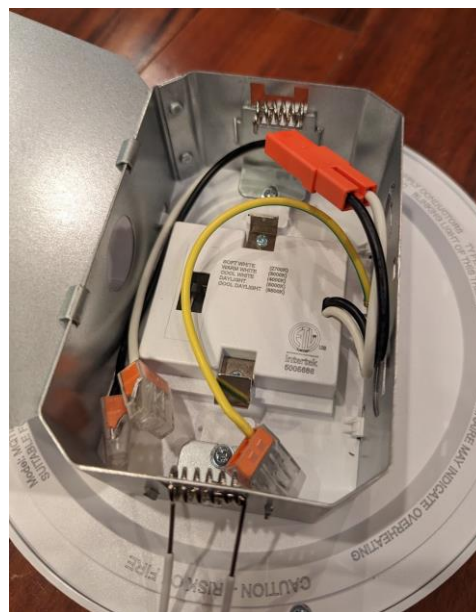

(e.g., when a consumer/user initially opens the product box, each plurality of wires extending from their respective white, black, or green/yellow insulations and is already twisted and inserted into their respective orange twist connector.



1
2
3
4
5
6
7
8
9
10
11
12
13
14
15
16
17
18
19
20
21
22
23
24
25
26
27
28

A plurality of wires was removed from a twist connector for capturing the above-image to reveal the twisted and coated plurality of wires.)

wherein the retrofit clips (102) make a friction fit inside the recessed lighting fixture housing to secure the complete fixture (112) inside,

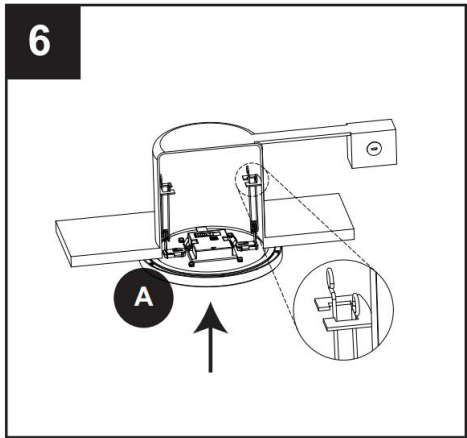

wherein the new construction clips (104) are attached to the connecting posts (106) if the recessed lighting fixture housing is not present.

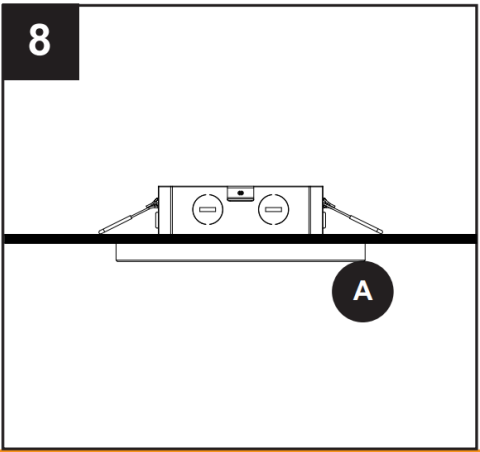

From Lowe’s website:

“*One* recessed downlight, *three* ways to install! The versatile *3 in 1* recessed

1
2
3
4
5
6
7
8
9
10
11
12
13
14
15
16
17
18
19
20
21
22
23
24
25
26
27
28

	<p>downlight comes with everything you need to either hardwire to existing ceiling j-box, direct wire to the fixture with attachable integrated j-box, or install in existing can with the E26 screw in base.”</p> <p>See:</p> <p>https://www.lowes.com/pd/Utilitech-UT-5-or-6-IN-CCT-3-1-UNIV-DL-6-Ct-White-5-in-or-6-in-800-Lumen-Cool-White-Round-Dimmable-Recessed-Downlight-6-Pack/5013469735</p> <p>(emphasis added)</p>
--	---------------------------------------------------------------------------------------------------------------------------------------------------------------------------------------------------------------------------------------------------------------------------------------------------------------------------------------------------------------------------------------------------------------------------------------------------------------------------------------------------------------------------------------------------------------------------------------------------------------

147. TABLE 13 below provides a Claim mapping of Claim 2 from PLAINTIFF’S PATENT, and illustrates examples of how LOWES CHINA’S products (*e.g.*, Item #5041630, Item #5041632, and Item #5041634) infringe at least Claim 2 of PLAINTIFF’S PATENT.

148. Images in the right column of Table 13 include a screenshot of an instruction manual available through Lowe’s website (*e.g.*, Scroll to “Overview” and select “Manual PDF” at [https://www.lowes.com/pd/ Utilitech-UT-5-or-6-IN-CCT-3-1-UNIV-DL-6-Ct-White-5-in-or-6-in-800-Lumen-Cool-White-Round-Dimmable-Recessed-Downlight-6-Pack/5013469735](https://www.lowes.com/pd/Utilitech-UT-5-or-6-IN-CCT-3-1-UNIV-DL-6-Ct-White-5-in-or-6-in-800-Lumen-Cool-White-Round-Dimmable-Recessed-Downlight-6-Pack/5013469735)).

149. TABLE 13:

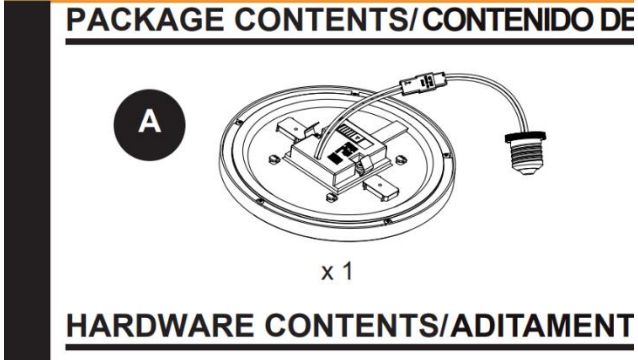
<p>2 <u>Claim 2 from DSAE Patent</u></p> <p>3</p> <p>4</p> <p>5</p> <p>6</p> <p>7</p> <p>8</p> <p>9</p> <p>10</p> <p>11</p>	<p>Images from product and manual for Lowe's:</p> <p>Item #5041630 Model #MQTL1183-LED12K9027</p> <p>Item #5041632 Model #MQTL1182-LED12K9027</p> <p>Item #5041634 Model #MQTL1182-LED12K9027</p>
<p>12 2. The apparatus according to claim 1</p> <p>13 comprises a socket adapter (114) to</p> <p>14 replace a light bulb in the recessed lighting</p> <p>15 fixture housing.</p> <p>16</p> <p>17</p> <p>18</p> <p>19</p>	

20 150. TABLE 14 below provides a Claim mapping of Claim 2 from PLAINTIFF'S

21 PATENT, and illustrates examples of how LOWES CHINA'S products (e.g., Item

22 #5041631 and Item #5041633) infringe at least Claim 2 of PLAINTIFF'S PATENT.

23 151. Images in the right column of Table 14 include a screenshot of an instruction

24 manual available through LOWES CHINA' website (e.g., Scroll to "Overview" and

25 select "Manual PDF" at <https://www.lowes.com/pd/Utilitech/5013345333>).

26

27

28

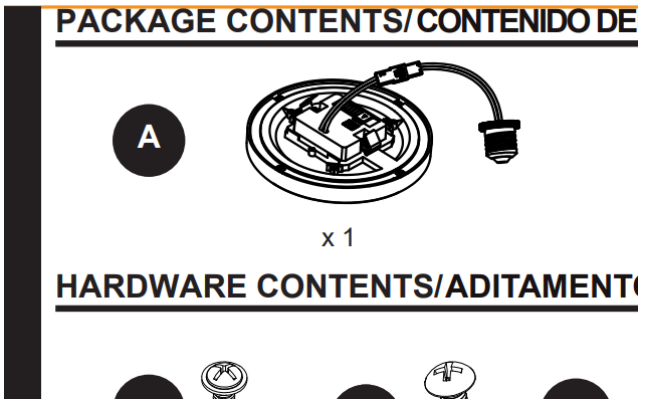

152. TABLE 14:

<p>2 <u>Claim 2 from DSAE Patent</u></p>	<p>Images of product and manual for Lowe's: Item #5041631 Model #MQTL1181-LED10K9027, and Item #5041633 Model #MQTL1181-LED10K9027</p>
<p>3 4 5 6 7 8 9 2. The apparatus according to claim 1 10 comprises a socket adapter (114) to 11 replace a light bulb in the recessed lighting 12 fixture housing.</p>	

17
18 153. TABLE 15 below provides a Claim mapping of Claim 3 from PLAINTIFF'S
19 PATENT, and illustrates examples of how LOWES CHINA'S products (e.g., Item
20 #5041630, Item #5041632, and Item #5041634) infringe at least Claim 3 of
21 PLAINTIFF'S PATENT.

22 154. Images in the right column of Table 15 include a screenshot of an instruction
23 manual available through LOWES CHINA's website (e.g., Scroll to "Overview" and
24 select "Manual PDF" at [https://www.lowes.com/pd/ Utilitech-UT-5-or-6-IN-CCT-3-1-UNIV-DL-6-Ct-White-5-in-or-6-in-800-Lumen-Cool-White-Round-Dimmable-Recessed-Downlight-6-Pack/5013469735](https://www.lowes.com/pd/Utilitech-UT-5-or-6-IN-CCT-3-1-UNIV-DL-6-Ct-White-5-in-or-6-in-800-Lumen-Cool-White-Round-Dimmable-Recessed-Downlight-6-Pack/5013469735)).
25
26



1 155.

TABLE 15:

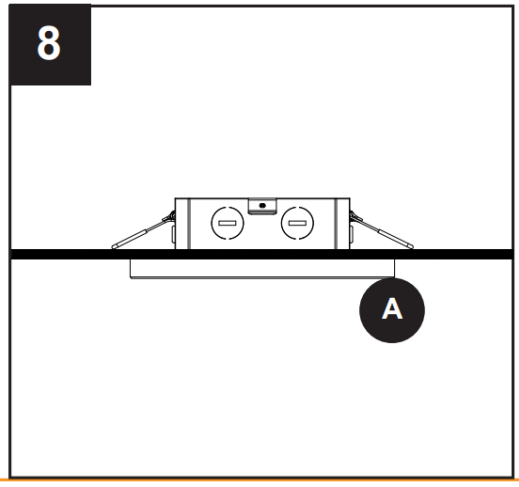
<p>2 <u>Claim 3 from DSAE Patent</u></p> <p>3</p> <p>4</p> <p>5</p> <p>6</p> <p>7</p> <p>8</p> <p>9</p>	<p>Images from product and manual for Lowe’s:</p> <p>Item #5041630 Model #MQTL1183-LED12K9027</p> <p>Item #5041632 Model #MQTL1182-LED12K9027</p> <p>Item #5041634 Model #MQTL1182-LED12K9027</p>
<p>10</p> <p>11 3. The apparatus according to claim 1,</p> <p>12 wherein the new construction clips (104)</p> <p>13 squeeze ceiling material placed between</p> <p>14 the new construction clips (104) and an</p> <p>15 extremity of the metal housing (108).</p> <p>16</p> <p>17</p> <p>18</p>	 <p>The diagram shows a cross-sectional view of a construction clip assembly. A central rectangular component with two circular features is mounted on a horizontal surface. Two angled clips are attached to the sides of this central component. A circular callout labeled 'A' points to the bottom edge of the central component. A black box with the number '8' is in the top-left corner of the diagram area.</p>

19 156. TABLE 16 below provides a Claim mapping of Claim 3 from PLAINTIFF’S

20 PATENT, and illustrates examples of how LOWES CHINA’S products (*e.g.*, Item

21 #5041631 and Item #5041633) infringe at least Claim 3 of PLAINTIFF’S PATENT.

22 157. Images in the right column of Table 16 include a screenshot of an instruction

23 manual available through LOWES CHINA’s website (*e.g.*, Scroll to “Overview” and

24 select “Manual PDF” at <https://www.lowes.com/pd/Utilitech/5013345333>).

25

26

27

28



1 158.

TABLE 16:

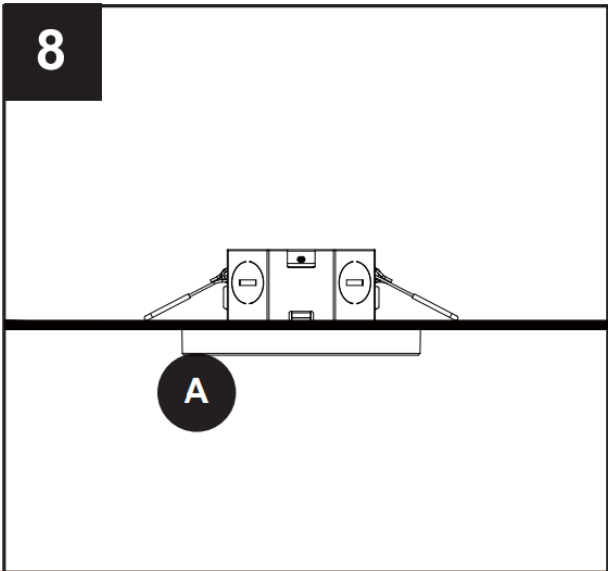
<p>2 <u>Claim 3 from DSAE Patent</u></p> <p>3</p> <p>4</p> <p>5</p> <p>6</p> <p>7</p> <p>8</p>	<p>Images of product and manual for Lowe's: Item #5041631 Model #MQTL1181- LED10K9027, and Item #5041633 Model #MQTL1181- LED10K9027</p>
<p>9 3. The apparatus according to claim 1, 10 wherein the new construction clips (104) 11 squeeze ceiling material placed between 12 the new construction clips (104) and an 13 extremity of the metal housing (108).</p> <p>14</p> <p>15</p> <p>16</p> <p>17</p> <p>18</p> <p>19</p>	 <p>The diagram shows a cross-section of a lighting fixture assembly. A central rectangular component is mounted on a horizontal surface. Two angled clips (104) are positioned on either side of the central component, appearing to hold it in place. Below the central component, a circular element labeled 'A' is visible. The entire assembly is labeled with a large number '8' in the top-left corner of the diagram's frame.</p>

20 159. TABLE 17 below provides a Claim mapping of Claim 4 from PLAINTIFF'S
21 PATENT, and illustrates examples of how LOWES CHINA'S products (e.g., Item
22 #5041630, Item #5041632, and Item #5041634) infringe at least Claim 4 of
23 PLAINTIFF'S PATENT.

24 160. Images in the right column of Table 17 include an image of a product purchased
25 directly from LOWES CHINA, and a screenshot of an instruction manual available
26 through LOWES CHINA's website (e.g., Scroll to "Overview" and select "Manual
27 PDF" at [https://www.lowes.com/pd/ Utilitech-UT-5-or-6-IN-CCT-3-1-UNIV-DL-6-Ct-](https://www.lowes.com/pd/Utilitech-UT-5-or-6-IN-CCT-3-1-UNIV-DL-6-Ct-)



1 White-5-in-or-6-in-800-Lumen-Cool-White-Round-Dimmable-Recessed-Downlight-6-
 2 Pack/5013469735).

3 161.

TABLE 17:

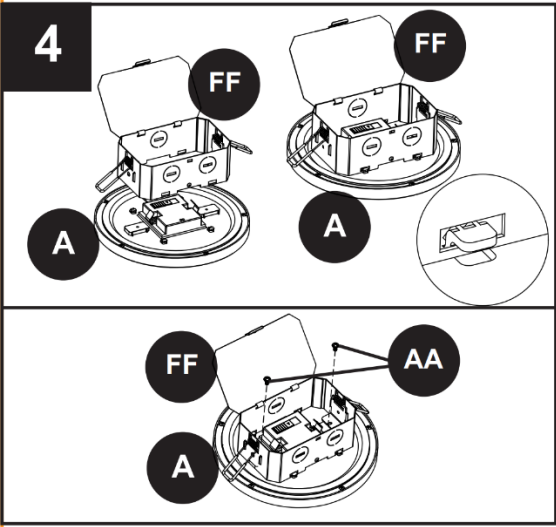
<p>4 <u>Claim 4 from DSAE Patent</u></p>	<p>Images from product and manual for Lowe's: Item #5041630 Model #MQTL1183- LED12K9027 Item #5041632 Model #MQTL1182- LED12K9027 Item #5041634 Model #MQTL1182- LED12K9027</p>
<p>13 4. The apparatus according to claim 1, 14 wherein the complete fixture (112) 15 comprises a plurality electrical systems, 16 clips, and accessories.</p>	



1
2
3
4
5
6
7
8
9
10
11
12
13
14
15
16
17
18
19
20
21
22
23
24
25
26
27
28



162. TABLE 18 below provides a Claim mapping of Claim 4 from PLAINTIFF’S PATENT, and illustrates examples of how LOWES CHINA’S products (*e.g.*, Item #5041631 and Item #5041633) infringe at least Claim 4 of PLAINTIFF’S PATENT.

163. Images in the right column of Table 18 include an image of a product purchased directly from LOWES CHINA, and a screenshot of an instruction manual available through LOWES CHINA’s website (*e.g.*, Scroll to “Overview” and select “Manual PDF” at <https://www.lowes.com/pd/Utilitech/5013345333>).

164. TABLE 18:

<p><u>Claim 4 from DSAE Patent</u></p>	<p>Images of product and manual for Lowe’s: Item #5041631 Model #MQTL1181-LED10K9027, and Item #5041633 Model #MQTL1181-LED10K9027</p>
----------------------------------------	------------------------------------------------------------------------------------------------------------------------------------------------

1 4. The apparatus according to claim 1,
 2 wherein the complete fixture (112)
 3 comprises a plurality electrical systems,
 4 clips, and accessories.
 5
 6
 7
 8
 9
 10
 11
 12
 13
 14
 15
 16
 17
 18
 19

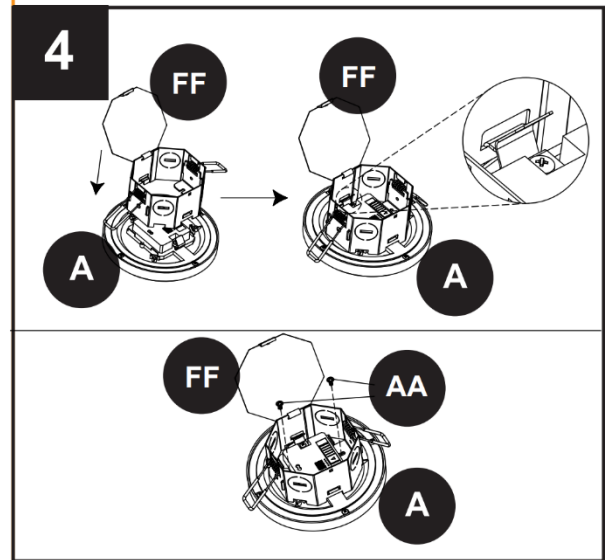

20 165. TABLE 19 below provides a Claim mapping of Claim 5 from PLAINTIFF’S
 21 PATENT, and illustrates examples of how LOWES CHINA’S products (*e.g.*, Item
 22 #5041630, Item #5041632, and Item #5041634) infringe at least Claim 5 of
 23 PLAINTIFF’S PATENT.

24 166. Images in the right column of Table 19 include an image of a product purchased
 25 directly from LOWES CHINA, and a screenshot of an instruction manual available
 26 through LOWES CHINA’s website (*e.g.*, Scroll to “Overview” and select “Manual
 27 PDF” at [https://www.lowes.com/pd/ Utilitech-UT-5-or-6-IN-CCT-3-1-UNIV-DL-6-Ct-](https://www.lowes.com/pd/Utilitech-UT-5-or-6-IN-CCT-3-1-UNIV-DL-6-Ct-)
 28



1 White-5-in-or-6-in-800-Lumen-Cool-White-Round-Dimmable-Recessed-Downlight-6-
 2 Pack/5013469735).

3 167.

TABLE 19:

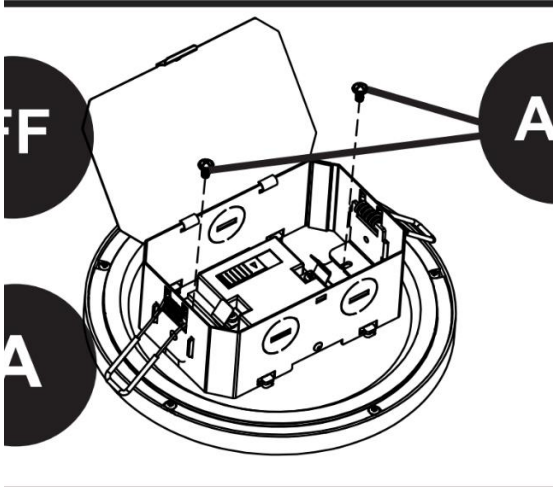
<p>4 <u>Claim 5 from DSAE Patent</u></p>	<p>Images from product and manual for Lowe's: Item #5041630 Model #MQTL1183- LED12K9027 Item #5041632 Model #MQTL1182- LED12K9027 Item #5041634 Model #MQTL1182- LED12K9027</p>
<p>5. The apparatus according to claim 1, wherein the junction box (116) allows an LED driver to be installed and comprises a predefined area to attach a plurality of wires.</p>	 <p>The image is a technical drawing of a recessed downlight junction box. It shows a cross-section of the box with an internal LED driver and wiring. Callout 'A' points to the junction box housing, and callout 'F' points to the LED driver component. The drawing is enclosed in a rectangular frame with horizontal lines at the top and bottom.</p>



1
2
3
4
5
6
7
8
9
10
11
12
13
14
15
16
17
18
19
20
21
22
23
24
25
26
27
28

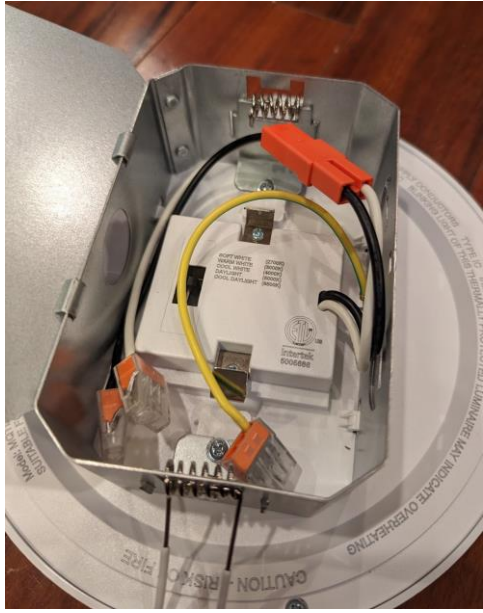

168. TABLE 20 below provides a Claim mapping of Claim 5 from PLAINTIFF’S PATENT, and illustrates examples of how LOWES CHINA’S products (*e.g.*, Item #5041631 and Item #5041633) infringe at least Claim 5 of PLAINTIFF’S PATENT.

169. Images in the right column of Table 20 include an image of a product purchased directly from LOWES CHINA, and a screenshot of an instruction manual available through LOWES CHINA’s website (*e.g.*, Scroll to “Overview” and select “Manual PDF” at <https://www.lowes.com/pd/Utilitech/5013345333>).

170. TABLE 20:

<p><u>Claim 5 from DSAE Patent</u></p>	<p>Images of product and manual for Lowe’s: Item #5041631 Model #MQTL1181-LED10K9027, and Item #5041633 Model #MQTL1181-LED10K9027</p>
----------------------------------------	------------------------------------------------------------------------------------------------------------------------------------------------

1 5. The apparatus according to claim 1,
2 wherein the junction box (116) allows an
3 LED driver to be installed and comprises a
4 predefined area to attach a plurality of
5 wires.
6
7
8
9
10
11
12
13
14
15
16
17

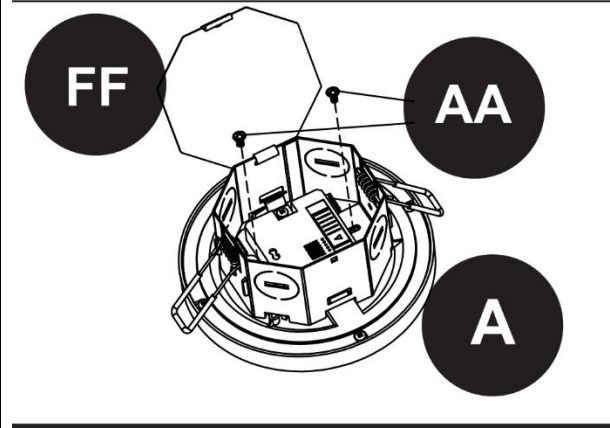

18 171. Tables 11-20 include respective Installation Manual images that have been
19 appended with text for explanation. For example, the phrases “Input wires from house”
20 and “Output wires attach to input wires from house” have been appended by
21 PLAINTIFF to the Installation Manual images for context and explanation.
22
23
24
25
26
27
28



DAMAGES ATTRIBUTABLE
TO LEDVANCE

172. PLAINTIFF repeats and realleges paragraphs 1-171 of this Complaint, as if fully set forth herein.

173. Upon information and belief, PLAINTIFF has been, and continues to be, damaged by the unlawful acts of the LEDVANCE, including, but not limited to, loss of sales, loss of profits, loss of market share, among other economic hardships.

174. PLAINTIFF estimates damages to be at least gross profits on sales of any of the LEDVANCE'S lighting products that infringe PLAINTIFF'S Patent.

175. PLAINTIFF estimates additional damages to be a royalty on ongoing sales of any of the LEDVANCE'S lighting products during the lifetime of PLAINTIFF'S Patent.

176. Upon information and belief, LEDVANCE have infringed, directly, indirectly, and/or by equivalents, PLAINTIFF'S PATENT by using, selling, and offering for sale LEDVANCE's lighting products from the United States, and importing into the United States, LEDVANCE's lighting products that embody each and every claim element of each respective claim of PLAINTIFF'S PATENT.

177. Upon information and belief, LEDVANCE have known of the existence of PLAINTIFF'S PATENT, and their egregious acts of infringement have been willful and in reckless disregard for the PLAINTIFF's rights per PLAINTIFF'S PATENT, without any basis for believing that LEDVANCE had a right to engage in the infringing conduct.

178. PLAINTIFF has sustained, and is likely to continue sustaining, actual damages due to LEDVANCE's activities, including lost sales and reduced market share resulting from LEDVANCE's infringing conduct.

179. Unless enjoined by this Court, LEDVANCE will continue to infringe PLAINTIFF'S PATENT and cause PLAINTIFF to suffer irreparable harm for which there is no adequate remedy at law. PLAINTIFF is thus entitled to an injunction against LEDVANCE.



DAMAGES ATTRIBUTABLE
TO LOWES CHINA

1
2
3 180. PLAINTIFF repeats and realleges paragraphs 1-179 of this Complaint, as if fully
4 set forth herein.

5 181. Upon information and belief, PLAINTIFF has been, and continues to be, damaged
6 by the unlawful acts of the LOWES CHINA, including, but not limited to, loss of sales,
7 loss of profits, loss of market share, among other economic hardships.

8 182. PLAINTIFF sent LOWES CHINA'S parent company, Lowe's Companies, Inc.,
9 cease and desist letters on or around May 8, 2023, via USPS certified mail. Lowe's
10 acknowledged and responded to these letters on or around June 11, 2023, but continued
11 to willfully import and sell their infringing products.

12 183. Upon information and belief, PLAINTIFF provides a fair assessment of damages
13 owed by the LOWES CHINA to be based on considering PLAINTIFF as a trader-
14 intermediary, between a manufacturer(s) (*e.g.*, PLAINTIFF'S manufacturer, or Zhejiang
15 Yankon Group Co. Ltd., etc.) and a retailer(s) (*e.g.*, LOWES CHINA), and that total
16 sales be based on the equivalent of sales of 2 units a week of Utilitech Item #5041634
17 and 1 unit a week of Utilitech Item #5041633, from each store of Lowe's "1,737" stores
18 that LOWE'S CHINA imports to (see Exhibit 46).

19 184. In accordance with Paragraph 183, PLAINTIFF requests the damages owed by
20 LOWES CHINA to be \$5,289,060.78 USD.

21 185. Upon information and belief, LOWES CHINA have not stopped engaging in their
22 willful and reckless infringing activities.

23 186. Upon information and belief, LOWES CHINA have infringed, directly, indirectly,
24 and/or by equivalents, PLAINTIFF'S PATENT by using, selling, and offering for sale
25 LOWES CHINA'S lighting products from the United States, and/or importing into the
26 United States, LOWES CHINA'S lighting products that embody each and every claim
27 element of each respective claim of PLAINTIFF'S PATENT.



1 187. Upon information and belief, LOWES CHINA have known of the existence of
2 PLAINTIFF'S PATENT, and their egregious acts of infringement have been willful and
3 in reckless disregard for the PLAINTIFF's rights per PLAINTIFF'S PATENT, without
4 any basis for believing that LOWES CHINA had a right to engage in the infringing
5 conduct.

6 188. PLAINTIFF has sustained, and is likely to continue sustaining, actual damages
7 due to LOWES CHINA'S activities, including lost sales and reduced market share
8 resulting from LOWES CHINA'S infringing conduct.

9 189. Unless enjoined by this Court, LOWES CHINA will continue to infringe
10 PLAINTIFF'S PATENT and cause PLAINTIFF to suffer irreparable harm for which
11 there is no adequate remedy at law. PLAINTIFF is thus entitled to an injunction against
12 LOWES CHINA.

13 **COUNT 1**

14 **(LEDVANCE'S Infringement of the PLAINTIFF's Patent)**

15 190. PLAINTIFF repeats and realleges paragraphs 1-189 of this Complaint, as if fully
16 set forth herein.

17 191. PLAINTIFF is the owner of all right, title, and interest in and to the validly issued
18 PLAINTIFF's Patent including all rights to enforce the PLAINTIFF's Patent.

19 192. Upon information and belief, LEDVANCE have been and are infringing, directly,
20 indirectly, and/or by equivalents, the PLAINTIFF's Patent by using, selling, offering for
21 sale from the United States, and/or importing into the United States, including within
22 California State and this District, LEDVANCE'S Products in violation of 35 U.S.C. §
23 271.

24 193. Upon information and belief, LEDVANCE'S alleged infringement has been, and
25 continues to be knowing, intentional, egregious, and willful.



1 194. LEDVANCE’S alleged acts of infringement of the PLAINTIFF’s Patent have
2 caused and will continue to cause PLAINTIFF damages for which PLAINTIFF is
3 entitled to compensation pursuant to 35 U.S.C. § 284.

4 195. LEDVANCE’S alleged acts of infringement of the PLAINTIFF’s Patent have
5 caused and will continue to cause PLAINTIFF immediate and irreparable harm unless
6 such infringing activities are enjoined by this Court pursuant to 35 U.S.C. § 283.

7 196. This case is exceptional and, therefore, PLAINTIFF is entitled to an award of
8 attorneys’ fees pursuant to 35 U.S.C. § 285.

9 **COUNT 2**

10 **(DEFENDANTS LOWES CHINA’S Infringement of the PLAINTIFF’s Patent)**

11 197. PLAINTIFF repeats and realleges paragraphs 1-196 of this Complaint, as if fully
12 set forth herein.

13 198. PLAINTIFF is the owner of all right, title, and interest in and to the validly issued
14 PLAINTIFF’s Patent including all rights to enforce the PLAINTIFF’s Patent.

15 199. Upon information and belief, LOWES CHINA have been and are infringing,
16 directly, indirectly, and/or by equivalents, the PLAINTIFF’s Patent by using, selling,
17 offering for sale from the United States, and/or importing into the United States,
18 including within California State and this District, LOWES CHINA’S Products in
19 violation of 35 U.S.C. § 271.

20 200. Upon information and belief, LOWES CHINA’S alleged infringement has been,
21 and continues to be knowing, intentional, egregious, and willful.

22 201. LOWES CHINA’S alleged acts of infringement of the PLAINTIFF’s Patent have
23 caused and will continue to cause PLAINTIFF damages for which PLAINTIFF is
24 entitled to compensation pursuant to 35 U.S.C. § 284.

25 202. LOWES CHINA’S alleged acts of infringement of the PLAINTIFF’s Patent have
26 caused and will continue to cause PLAINTIFF immediate and irreparable harm unless
27 such infringing activities are enjoined by this Court pursuant to 35 U.S.C. § 283.



1 203. This case is exceptional and, therefore, PLAINTIFF is entitled to an award of
2 attorneys' fees pursuant to 35 U.S.C. § 285.

3
4 **WHEREFORE**, Plaintiff requests judgment against Defendants as follows:
5 **(as regarding Count 1 ...)**

6 1. Adjudging, finding, and declaring that LEDVANCE'S lighting products have and
7 do infringe, directly or by equivalents, the PLAINTIFF's Patent, in violation of 35
8 U.S.C. § 271, and/or that each respective DEFENDANT is otherwise liable as an
9 infringer of the PLAINTIFF's Patent pursuant to 35 U.S.C. §§ 271(a), 271(b), and/or
10 271(c);

11 2. Granting an injunction and permanently enjoining LEDVANCE and
12 LEDVANCE'S employees, agents, officers, servants, directors, attorneys, successors,
13 affiliates, subsidiaries, and assigns, and all of those in active concert and participation
14 with any of the foregoing persons or entities from infringing the PLAINTIFF's Patent,
15 including all making, using, importing, advertising, offering for sale and selling
16 LEDVANCE'S infringing lighting products on any online shopping platforms, any
17 online sales platform, as well as others distributing or selling LEDVANCE'S infringing
18 lighting products to the public and/or retailers, permanently remove from their respective
19 platforms any and all sales pages illustrating, featuring, mentioning, selling, offering for
20 sale LEDVANCE'S lighting products, or any other relevant products, pursuant to 35
21 U.S.C. §283;

22 3. Ordering LEDVANCE to account for all sales (domestically and internationally),
23 revenues, profits, and expenses, and ordering LEDVANCE to pay PLAINTIFF for
24 LEDVANCE'S wrongful gains and in furtherance of deterrence, and/or otherwise pay
25 actual and compensatory damages adequate to compensate PLAINTIFF for
26 LEDVANCE'S infringement of the PLAINTIFF's Patent, with pre-judgment and post-
27 judgment interest and costs, pursuant to 35 U.S.C. § 284; and

28



1 4. Ordering that damages be awarded and increased in an amount up to three times
2 the actual amount assessed, as deterrence, pursuant to 35 U.S.C. § 284;

3 5. Declaring this case exceptional and awarding PLAINTIFF its reasonable
4 attorneys' fees, pursuant to 35 U.S.C. §285.

5 6. Ordering LEDVANCE to provide PLAINTIFF with sufficient information to
6 determine any past and/or present source of manufacturing, any suppliers, and any
7 distributors of LEDVANCE'S lighting products;

8 7. Ordering LEDVANCE to provide PLAINTIFF with sufficient information to
9 determine details regarding communications, relevant decisions for action, and/or
10 inaction with respect to infringing the PLAINTIFF's Patent, manufacturing
11 LEDVANCE'S lighting products, importing LEDVANCE'S lighting products, and/or
12 otherwise making LEDVANCE'S lighting products available for purchase.

13 8. Ordering LEDVANCE to provide PLAINTIFF with sufficient information to
14 determine details regarding relevant communications, purchases, cancelations, and/or
15 agreements between LEDVANCE and any other associated lighting parts retailer, seller,
16 manufacturer, importer, and/or trade broker.

17 9. Ordering LEDVANCE to pay for expenses incurred by PLAINTIFF for and
18 associated with monitoring LEDVANCE'S infringing activities, and interacting with
19 LEDVANCE, their agents, and any other persons or entities to prevent LEDVANCE'S
20 infringing activities.

21 10. An order requiring LEDVANCE to pay enhanced damages, as a deterrence, due to
22 LEDVANCE'S reckless, egregious, and willful acts.

23 11. Awarding any such other and further relief as this Court deems just and proper.
24

25 **(as regarding Count 2 ...)**

26 1. Adjudging, finding, and declaring that LOWES CHINA'S lighting products have
27 and do infringe, directly or by equivalents, the PLAINTIFF's Patent, in violation of 35
28



1 U.S.C. § 271, and/or that each respective DEFENDANT is otherwise liable as an
2 infringer of the PLAINTIFF's Patent pursuant to 35 U.S.C. §§ 271(a), 271(b), and/or
3 271(c);

4 2. Granting an injunction and permanently enjoining LOWES CHINA and LOWES
5 CHINA'S employees, agents, officers, servants, directors, attorneys, successors,
6 affiliates, subsidiaries, and assigns, and all of those in active concert and participation
7 with any of the foregoing persons or entities from infringing the PLAINTIFF's Patent,
8 including all making, using, importing, advertising, offering for sale and selling LOWES
9 CHINA'S infringing lighting products on any online shopping platforms, any online
10 sales platform, as well as others distributing or selling LOWES CHINA'S infringing
11 lighting products to the public and/or retailers, permanently remove from their respective
12 platforms any and all sales pages illustrating, featuring, mentioning, selling, offering for
13 sale LOWES CHINA'S lighting products, or any other relevant products, pursuant to 35
14 U.S.C. §283;

15 3. Ordering LOWES CHINA to account for all sales (domestically and
16 internationally), revenues, profits, and expenses, and ordering LOWES CHINA to pay
17 PLAINTIFF for LOWES CHINA'S wrongful gains and in furtherance of deterrence,
18 and/or otherwise pay actual and compensatory damages adequate to compensate
19 PLAINTIFF for LOWES CHINA'S infringement of the PLAINTIFF's Patent, with pre-
20 judgment and post-judgment interest and costs, pursuant to 35 U.S.C. § 284; and

21 4. Ordering that damages be awarded and increased in an amount up to three times
22 the actual amount assessed, as deterrence, pursuant to 35 U.S.C. § 284;

23 5. Declaring this case exceptional and awarding PLAINTIFF its reasonable
24 attorneys' fees, pursuant to 35 U.S.C. §285.

25 6. Ordering LOWES CHINA to provide PLAINTIFF with sufficient information to
26 determine any past and/or present source of manufacturing, any suppliers, and any
27 distributors of LOWES CHINA'S lighting products;

28



1 7. Ordering LOWES CHINA to provide PLAINTIFF with sufficient information to
2 determine details regarding communications, relevant decisions for action, and/or
3 inaction with respect to infringing the PLAINTIFF's Patent, manufacturing LOWES
4 CHINA'S lighting products, importing LOWES CHINA'S lighting products, and/or
5 otherwise making LOWES CHINA'S lighting products available for purchase.

6 8. Ordering LOWES CHINA to provide PLAINTIFF with sufficient information to
7 determine details regarding relevant communications, purchases, cancelations, and/or
8 agreements between LOWES CHINA and any other associated lighting parts retailer,
9 seller, manufacturer, importer, and/or trade broker.

10 9. Ordering LOWES CHINA to pay for expenses incurred by PLAINTIFF for and
11 associated with monitoring LOWES CHINA'S infringing activities, and interacting with
12 LOWES CHINA, their agents, and any other persons or entities to prevent LOWES
13 CHINA'S infringing activities.

14 10. An order requiring LOWES CHINA to pay enhanced damages, as a deterrence,
15 due to LOWES CHINA'S reckless, egregious, and willful acts.

16 11. Awarding any such other and further relief as this Court deems just and proper.
17

18 **JURY DEMAND**

19 Pursuant to Rule 38, Fed. R. Civ. P., Plaintiff demands a trial by jury on all issues
20 so triable.
21

22 Dated: October 9, 2023

23 **CUMMINS IP PLLC**

24 /s/ Patrick Cummins,

25 Patrick Cummins, CA Bar No. 294400

26 3426 Pepperhill Rd.

27 Lexington, KY 40502
28



1 Telephone: (502) 445-9880
2 Patrick@CumminsIP.com
3 *Counsel for Plaintiff,*
4 *DS Advanced Enterprises, Ltd.*

5
6
7
8
9
10
11
12
13
14
15
16
17
18
19
20
21
22
23
24
25
26
27
28