

**IN THE UNITED STATES DISTRICT COURT
FOR THE DISTRICT OF DELAWARE**

UNGER MARKETING INTERNATIONAL, LLC,)	
)	
Plaintiff,)	C.A. No.
)	
v.)	JURY TRIAL DEMANDED
)	
MOERMAN N.V., AND MOERMAN AMERICAS, INC.,)	
)	
Defendants.)	
)	

COMPLAINT

Plaintiff Unger Marketing International, LLC, (“Unger”), complains against Defendants Moerman N.V., and Moerman Americas, Inc. (“Moerman Americas”) (collectively, “Moerman” or “Defendants”) as follows:

THE PARTIES

1. Plaintiff Unger Marketing International, LLC, (“Unger”) is a limited liability company organized and existing under the laws of the State of Delaware, with its principal place of business at 425 Asylum Street, Bridgeport, CT 06610.
2. Upon information and belief, Defendant Moerman N.V. is a corporation organized and existing under the laws of the country of Belgium, with its principal place of business located at Schutterijstraat 25, 8760 Meulebeke, Belgium.
3. Upon information and belief, Moerman N.V. is a cleaning tool company with extensive operations in the United States. Moerman N.V. directly and through its subsidiaries, distributors, and other intermediaries makes, uses, sells, and/or imports in the United States,

various cleaning products, such as window cleaning tools, floor cleaning tools, and related products, including the products accused of infringement in this case.

4. Upon information and belief, Defendant Moerman Americas is a corporation organized and existing under the laws of the State of Delaware. Upon information and belief, Moerman Americas has its principal place of business located at 2010 Crow Canyon Pl #100, San Ramon, CA 94583. Moerman Americas is, upon information and belief, a wholly-owned subsidiary of Moerman N.V. Moreover, Moerman Americas has been held out as a branch of Moerman N.V. by Defendants themselves.¹

JURISDICTION AND VENUE

5. This is an action for patent infringement arising under the patent laws of the United States, Title 35 U.S.C. §§ 1 *et seq.* This Court has subject matter jurisdiction over the claims pursuant to 28 U.S.C. §§ 1331 and 1338(a).
6. This Court has personal jurisdiction over Defendants because, upon information and belief, Moerman has committed patent infringement in this judicial district and elsewhere that led to foreseeable harm and injury to Unger.
7. Moreover, upon information and belief, Moerman Americas is a Delaware corporation and is therefore subject to personal jurisdiction in Delaware.
8. This Court also has personal jurisdiction over Moerman Americas because, upon information and belief, Moerman Americas has established minimum contacts within the forum such that the exercise of jurisdiction over Moerman Americas will not offend traditional notions of fair

¹ See <https://moermangroup.com/en/about-us/> (“In the 1960s, our company began exporting and in the 1990s, we opened **a branch in America.**”) (emphasis added) (last accessed Apr. 29, 2024).

play and substantial justice.

9. Moreover, upon information and belief, Moerman Americas has placed products that practice the claimed design of the patent-in-suit into the stream of commerce with the reasonable expectation and/or knowledge that purchasers and users of such products were located within this District. Upon information and belief, Moerman Americas has sold, advertised, marketed, and distributed products in this District that practice the claimed design of the patent-in-suit.
10. This Court has jurisdiction over Defendant Moerman N.V. because, on information and belief, Moerman N.V. has placed products that practice the claimed design of the patent-in-suit into the stream of commerce with the reasonable expectation and/or knowledge that purchasers and users of such products were located within this District. Additionally, upon information and belief, Moerman N.V. has sold, advertised, marketed, and distributed products in this District that practice the claimed design of the patent-in-suit.
11. This Court has jurisdiction over Moerman N.V. because, on information and belief, Moerman N.V. is in the business of manufacturing, marketing, using, selling, and/or offering for sale in the United States, including this District, the accused window cloth products directly, or through its wholly-owned subsidiaries, including Moerman Americas. Upon information and belief, Moerman N.V., directly or indirectly through its wholly-owned subsidiaries, including at least Moerman Americas, offers for sale and sells the accused products throughout the United States and in this District.
12. Additionally, upon information and belief, as the corporate parent of Moerman Americas, Moerman N.V. directs and is involved in the activities of Moerman Americas, including engaging in substantial and ongoing business in this District, including regularly doing or soliciting business, engaging in other persistent courses of conduct, and/or deriving substantial

revenue from selling products and services to individuals and entities in this District.

13. This Court also has personal jurisdiction over Moerman N.V. because, upon information and belief, Moerman N.V. has established minimum contacts within the forum such that the exercise of jurisdiction over Moerman N.V. will not offend traditional notions of fair play and substantial justice. Moreover, upon information and belief, Moerman N.V. has placed products that practice the claimed design of the patent-in-suit into the stream of commerce with the reasonable expectation and/or knowledge that purchasers and users of such products were located within this District. Upon information and belief, Moerman N.V. has sold, advertised, marketed, and distributed products in this District that practice the claimed design of the patent-in-suit.
14. Venue is proper in this District pursuant to 28 U.S.C. § 1400(b). Defendants have committed, and are continuing to commit, acts of patent infringement in this District; Defendants reside in this District and/or maintain regular business operations in this District.

UNGER'S PATENT

15. This action arises out of Defendants' infringement of a design patent owned by Unger.
16. On February 15, 2011, United States Design Patent No. D632,855 ("the D855 Patent"), titled "Cleaning Cloth with Corner Pocket," was duly and legally issued by the United States Patent and Trademark Office. The D855 Patent has been duly and legally assigned to Unger. A true and correct copy of the D855 Patent is attached as Exhibit A.
17. Unger is the owner of all right, title, and interest in the D855 Patent with the full and exclusive

right to bring suit to enforce the Unger Patents.

18. The D855 Patent is presumed to be valid and enforceable under 35 U.S.C. § 282.

UNGER'S PATENTED PRODUCT

19. Unger is an innovator in window cleaning technology, particularly microfiber window cleaning cloths. Unger has made significant investments in building its business and reputation, including through its investment of employee time for research and development as well as building its innovative intellectual property portfolio.

20. Due to its investments and innovative culture, Unger has been awarded numerous patents in the cleaning field, including the patent asserted in this litigation.

21. Unger sells a number of window cleaning products, including microfiber window cleaning cloths that embody the design claimed by the patent-in-suit.

22. Unger has expended significant time and energy in developing a cohesive visual design across its range of window cleaning products, including the products that embody the patent-in-suit, as part of its attempt to fashion a recognizable brand image within the relevant consumer market.

23. Among the Unger products that embody Unger's patented design is, for example, the Ninja

MicroWipe™ Cloth. An exemplary patented product is depicted below.



24. Unger’s microfiber cloth products compete in the marketplace with Moerman’s cleaning cloth products, including those products now accused of infringement and in particular at least the Bamboo Microfiber Cloth², Bamboo Window Cloth³, and PRO Bamboo Window Cloth⁴ products (together the “Accused Products”).

PATENT INFRINGEMENT

25. Defendants design, make, import, use, sell, and/or offer for sale a wide range of window cleaning products, such as microfiber window cloth products, including but not limited to the Accused Products.

26. As alleged herein, Defendants have engaged in actions that directly infringe the D855 Patent.

27. Defendants have directly infringed the D855 Patent, under 35 U.S.C. § 271(a), by making,

² <https://moermangroup.com/en/products/bamboo-microfiber-cloth/> (last accessed Apr. 29, 2024)

³ <https://moermangroup.com/en/products/bamboo-window-cloth/> (last accessed Apr. 29, 2024)

⁴ <https://moermangroup.com/en/products/pro-bamboo-window-cloth/> (last accessed Apr. 29, 2024).

using, selling, offering to sell, and/or importing infringing products into the United States.





28. The Accused Products are substantially similar to the design claimed in the D855 Patent, and upon information and belief, an ordinary consumer of cleaning cloths such as the Accused Products and the claimed design would be deceived by the Accused Products, and would purchase the Accused Products thinking they were the claimed design.

COUNT ONE
Infringement of the D855 Patent

29. Plaintiff repeats and re-alleges the allegations of paragraphs 1-28 above as if fully set forth herein.

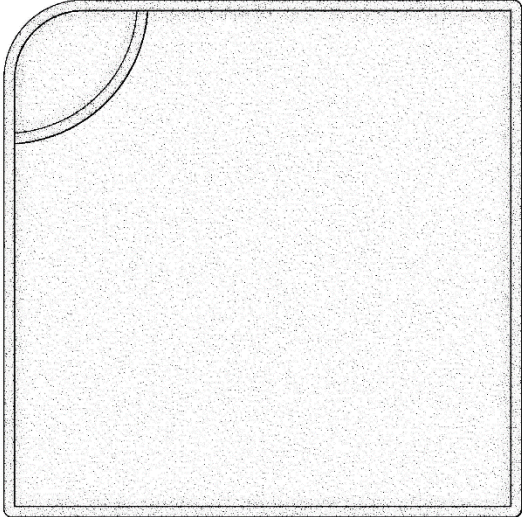
30. Because of the competitive nature of the industry and the discerning nature of the consumer, visual design details are important in distinguishing products.

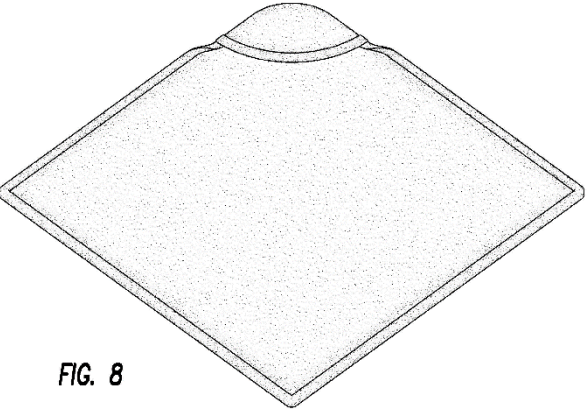
31. Upon information and belief, and as shown in the table below containing a side-by-side comparison of the claimed design and the exemplary accused PRO Bamboo Window Cloth, Bamboo Window Cloth, and the Bamboo Microfiber Cloth, the ordinary purchaser of such industrial cleaning cloths would consider the Moerman Accused Products substantially similar to the claimed design. Upon further information and belief, the ordinary purchaser of these products would be induced to purchase the Moerman Accused Products, thinking they were the patented design.

<u>D855 Patent</u>	<u>Moerman PRO Bamboo Window Cloth</u>
	
 <p data-bbox="279 1453 354 1486">FIG. 8</p>	

D855 Patent

Moerman Bamboo Window Cloth

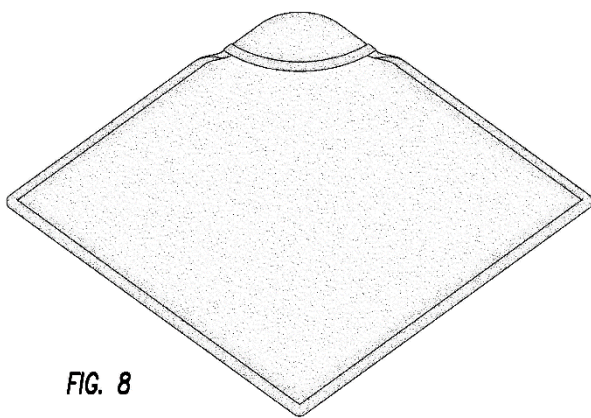
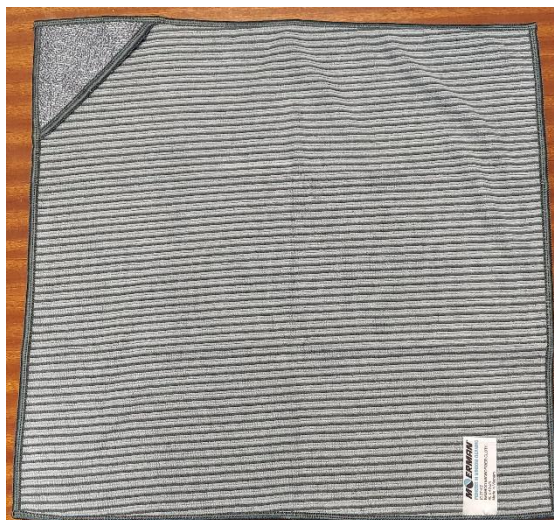
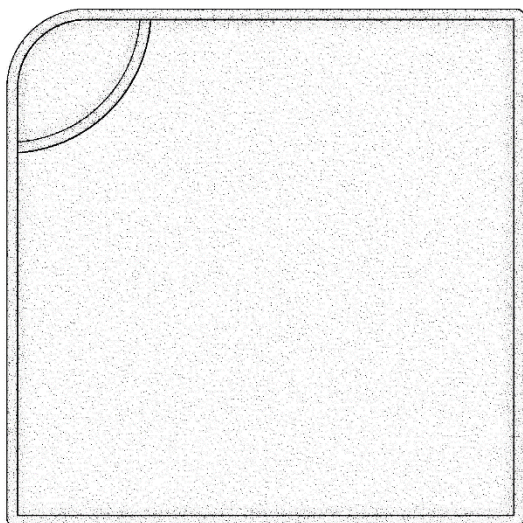
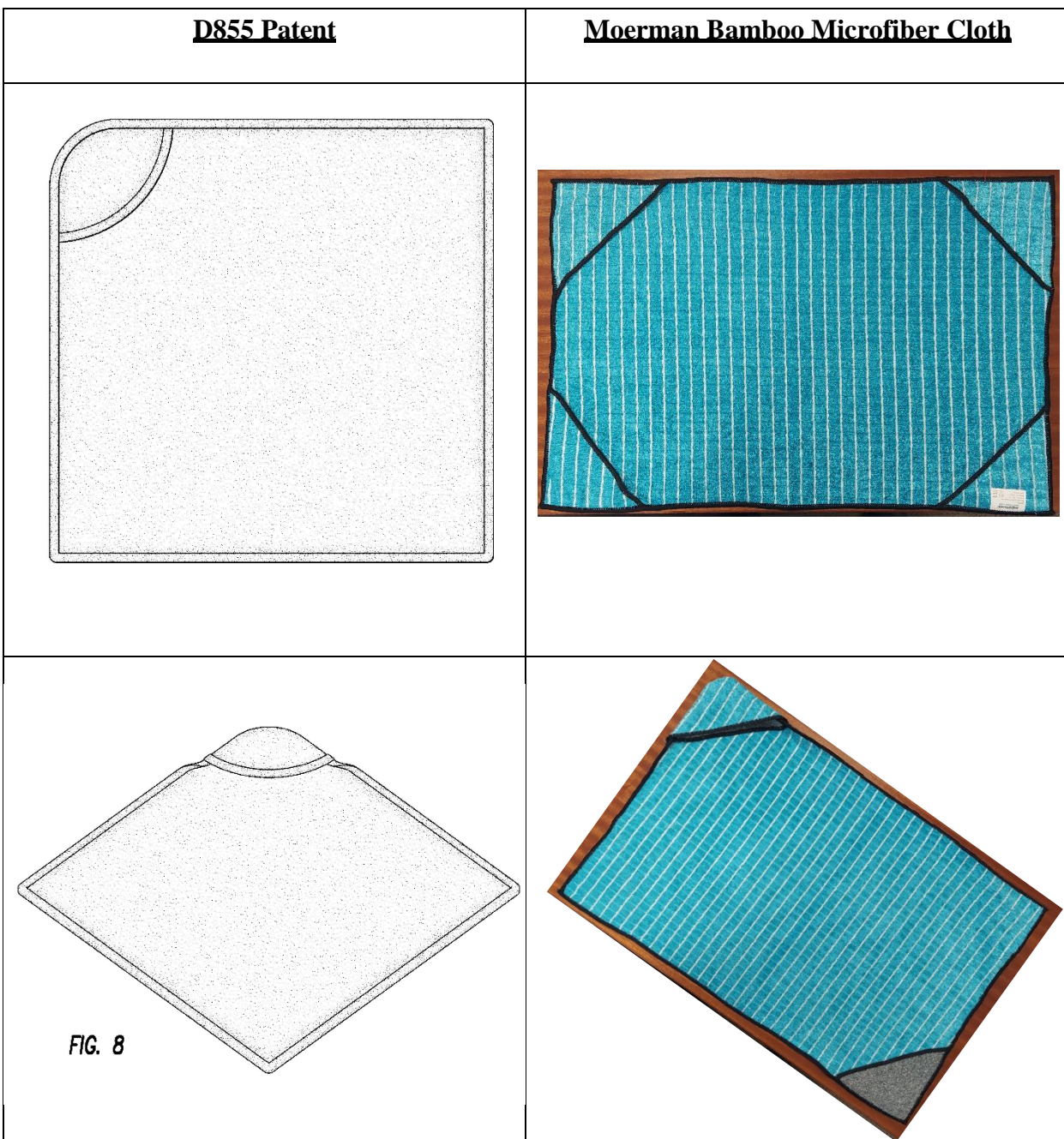

FIG. 8





32. Therefore, Defendants have infringed Unger’s D855 Patent through their manufacture, use, offers to sell, and sale of at least the Accused Products, including the exemplary Accused Products shown above.

33. Defendants have infringed and continue to infringe the claim of the D855 Patent, in violation

of 35 U.S.C. § 271(a), by making, using, selling, offering to sell and/or importing infringing products—including but not limited to the Accused Products—in the United States.

DAMAGES

34. Unger has suffered, is suffering, and unless restrained by the Court, will continue to suffer injury to its business and property rights as a result of Defendants' patent infringement, for which it is entitled to damages pursuant to 35 U.S.C. §§ 284, 285, and/or 289 in an amount to be proven at trial.

INJUNCTION

35. Unger has suffered, is suffering, and unless restrained by the Court, will continue to suffer irreparable harm for which there is no adequate remedy at law, as a result of Defendants' patent infringement, for which it is entitled to permanent injunctive relief pursuant to 35 U.S.C. § 283.

PRAYER FOR RELIEF

WHEREFORE, Plaintiff Unger requests that the Court enter judgment in its favor and against Defendants as follows:

- a. Declare that Defendants have infringed the D855 Patent;
- b. Enter preliminary and permanent injunctions prohibiting Defendants, its subsidiaries, segments, divisions, agents, employees, and all parties who are in privity with Defendants and/or any of the foregoing from infringing, contributing to the infringement of, and/or inducing infringement of the D855 Patent, and for all further proper injunctive relief;
- c. Award Unger damages for Defendants' infringement, with pre-judgment and post-judgment interest pursuant to 35 U.S.C. §§ 284-285;
- d. Award to Unger Defendants' total profit for design patent infringement pursuant to 35

U.S.C. § 289;

- e. Find this an exceptional case and award fees under 35 U.S.C. § 285;
- f. Grant any and all such further relief as the Court deems just and proper.

DEMAND FOR JURY TRIAL

Pursuant to Fed. R. Civ. P. 38(b) and Local Rule 38.1, Plaintiff Unger demands a trial by jury on all issues so triable.

Date: May 2, 2024

MCCARTER & ENGLISH, LLP

/s/ Brian R. Lemon

Brian R. Lemon (#4730)
Alexandra M. Joyce (#6423)
Renaissance Centre
405 N. King Street, 8th Flr.
Wilmington, DE 19801
Telephone 302.984.6300
Facsimile 302.984.6399
blemon@mccarter.com
ajoyce@mccarter.com

Lee Bromberg (Mass. BBO #058480)
Leah R. McCoy (Mass. BBO #673266)
MCCARTER & ENGLISH, LLP
265 Franklin Street
Boston, MA 02110-3113
Telephone 617.449.6500
Facsimile 617.607.9200
lbromberg@mccarter.com
lmccoy@mccarter.com

Attorneys for Plaintiff
UNGER MARKETING
INTERNATIONAL, LLC